







24

	SERVICE  → 
	(0) 91 23 95 50 
	(0) 17 18 11 43 24 
	(0) 91 23 18 51 55
	(0) 91 23 18 52 19
	(0) 91 23 30 85
	Service + Spare parts
	e-mail: service@tadanofaun.de
	e-mail: spareparts@tadanofaun.de
	 → ++49

TADANO FAUN GmbH
 Postfach 10 02 64
 D-91205 Lauf/Germany
 Tel. (0) 91 23 95 50
 Fax (0) 91 23 30 85
<http://www.tadanofaun.de>
 e-mail: info@tadanofaun.de

ALL-TERRAIN
ATF 110G-5

ISO 9001

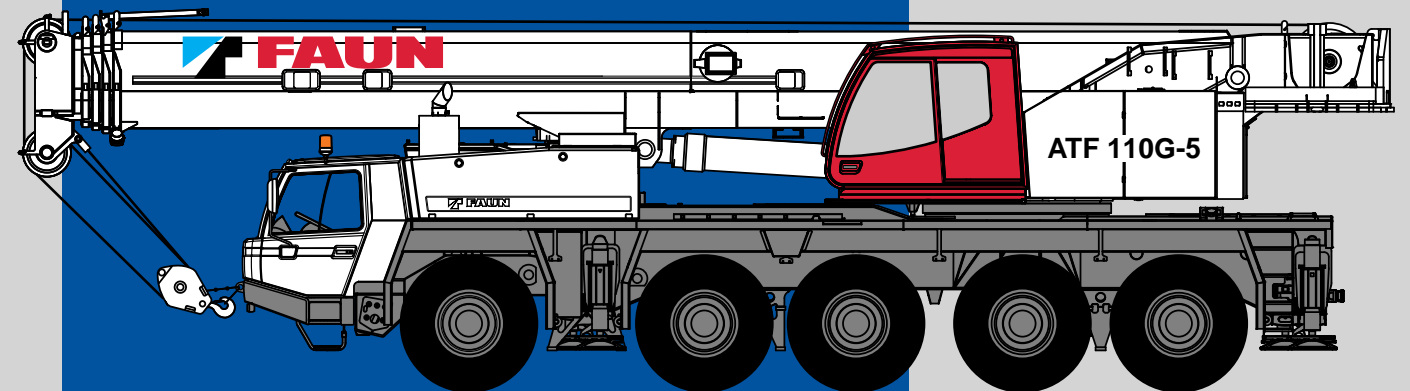

Maße (mm)
 Dimensions (mm)
 Dimensiones (mm)

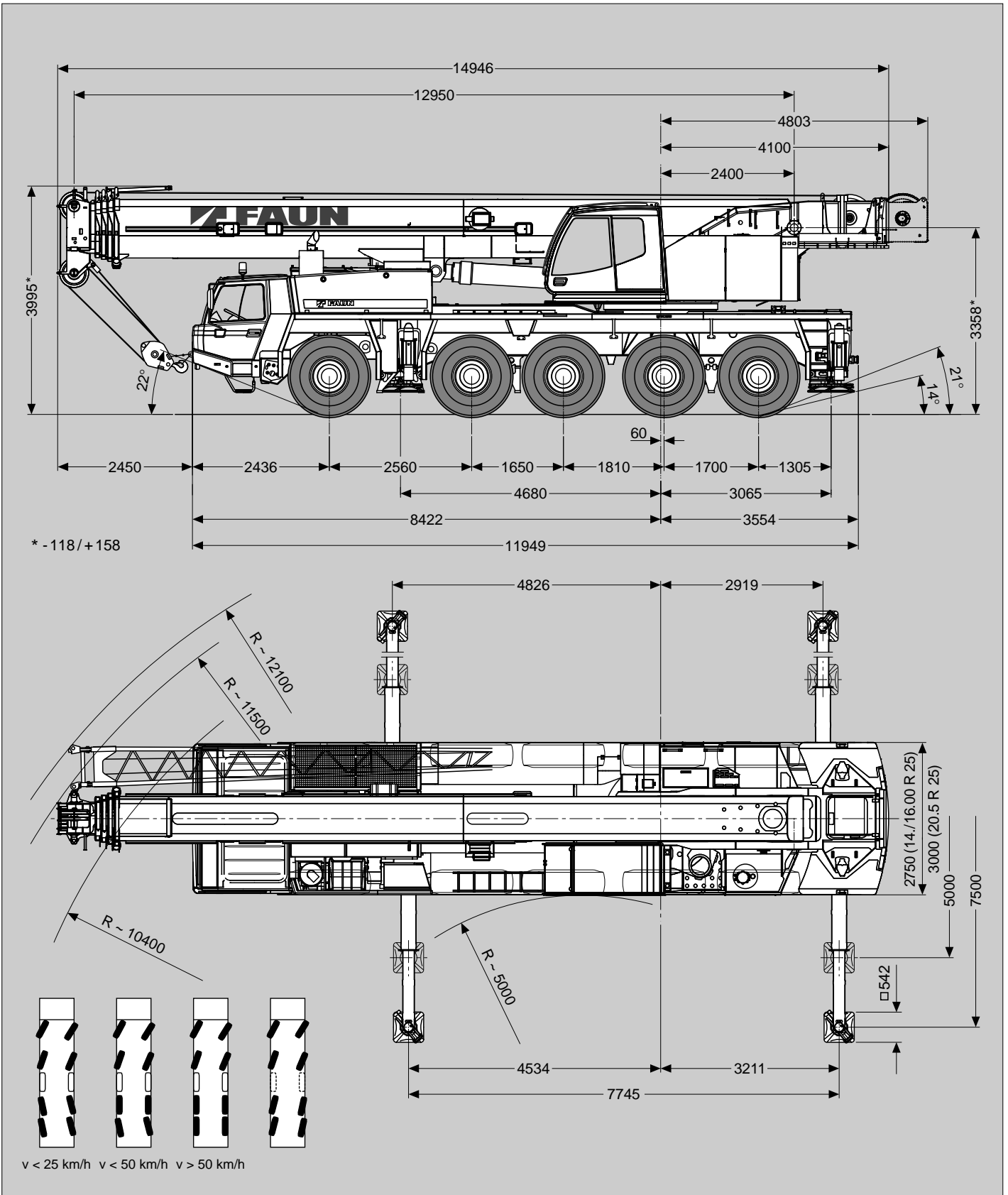
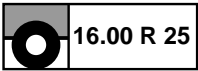

Gewichte / Geschwindigkeiten
Weights / Working speeds
Poids / Vitesses
Pesos / Velocidades de trabajo

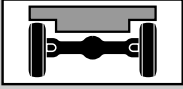

	Achse / Axle Essieu / Eje	1	2	3	4	5	Gesamtgewicht / Total weight Poids total / Peso total
	(t)	12	12	12	12	12	60*
	(t)	10.4	10.4	10.4	8.4	8.4	48**

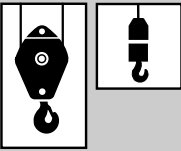
* Incl. 8,7 t Gegengewicht, 9,5 m / 16,2 m Auslegerverlängerung, 25 t Unterflasche, 10 t Hakengeschirr, Antrieb 10 x 8, Bereifung 16.00 R 25. ** Mit 0 t Gegengewicht, 25 t Unterflasche, Antrieb 10 x 6, Bereifung 14.00 R 25.
* Incl. 8.7 t counterweight, 9.5 m / 16.2 m boom extension, 25 t hook block, 10 t swivel hook, drive 10 x 8, tyres 16.00 R 25. ** With 0 t counterweight, 25 t hook block, drive 10 x 6, tyres 14.00 R 25.
* Incl. de 8,7 t contrepoids, 9,5 m / 16,2 m fléchette, 25 t moufle, 10 t élingues, entraînement 10 x 8, pneus 16.00 R 25. ** Avec 0 t contrepoids, 25 t moufle, entraînement 10 x 6, pneus 14.00 R 25.
* Incl. contrapeso de 8,7 t, 9,5 m / 16,2 m plumin, 25 t gancho, 10 t gancho de bola, tracción 10 x 8, neumáticos 16.00 R 25. ** Con contrapeso de 0 t, 25 t gancho, tracción 10 x 6, neumáticos 14.00 R 25.





	Traglast / Lifting capacity / Force de levage / Capacidad de elevación	Rollen / Sheaves Pulies / Poleas	Stränge / Parts of line Brins / Ramales de cable	Gewicht / Weight Poid / Peso
	125 t*	7	15	1200 kg
	80 t*	5	11	800 kg
	63 t*	3	7	600 kg
	63 t	3	7	600 kg
	25 t	1	3	300 kg
	10 t	-	1	200 kg

* Doppelhaken
* Rams horn
* Moufle avec crochet marin
* Gancho doble



	1	2	3	4	5	6	7	8	9	10	11	12	13	14	15	16	R1	R2	
	16.00 km/h	3	3	4	4	5	7	8	9	11	14	17	20	24	30	35	42	3	
	6	7	8	10	12	15	18	21	26	31	38	46	56	68	80	85	6	7	47%

* Mit Geländeübersetzung
* Off road range
* Avec mode tout terrain
* Con transmisión todo terreno

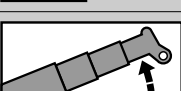
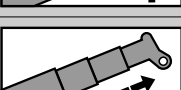
V+ 	Stufenlos Infinitely variable Progressivement variable Infinitamente variable	Seil Rope Câble Cable	Max. Seilzug Max. single line pull Effort maxi au brin simple Trio máximo por ramal
	0 - 130 m/min für einfachen Strang single line au brin simple ramal simple	21 mm / 250 m	95 kN 1. Lage 1 st layer 1 ^{er} brin capa 1
	0 - 130 m/min für einfachen Strang single line au brin simple ramal simple	21 mm / 250 m	95 kN 1. Lage 1 st layer 1 ^{er} brin capa 1
	0 - 1.7 min ⁻¹		
	-2.0° - +82° ca. 42 s approx. 42 s env. 42 s aproximadamente 42 s		
	13.0 m - 52.0 m ca. 320 s approx. 320 s env. 320 s aproximadamente 320 s		

Tragfähigkeiten
Lifting capacities
Capacités de levage
Capacidades de elevación

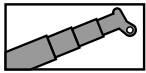

35t

DIN/ISO

 m	13.0 m*	13.0 m	17.4 m	21.9 m	26.4 m	30.9 m	35.4 m	39.9 m	44.4 m	48.9 m	52.0 m
3.0	110.0**	95.0**	80.0	67.0							
3.5	98.9**	87.2	80.0	65.6							
4.0	91.8	80.4	77.6	64.3	50.0						
4.5	86.0	74.6	74.1	60.9	48.9						
5.0	77.8	69.5	69.0	57.4	47.8	36.0					
6.0	64.7	61.0	60.4	51.1	45.7	36.0	28.0				
7.0	55.1	54.2	53.6	47.0	43.3	36.0	28.0	22.0			
8.0	47.8	47.8	47.1	47.0	41.4	35.0	28.0	22.0	18.0		
9.0	42.1	42.1	42.7	42.8	39.6	34.0	26.9	22.0	18.0	14.0	
10.0	37.5	37.5	38.1	38.1	37.6	32.9	25.8	22.0	18.0	14.0	11.5
11.0			34.3	34.3	35.0	31.9	24.7	21.2	18.0	14.0	11.5
12.0			31.1	31.1	31.8	30.9	23.6	20.5	18.0	14.0	11.5
14.0			24.8	25.9	25.9	25.3	21.7	18.9	16.9	14.0	11.5
16.0				21.2	21.1	20.6	20.6	17.4	15.9	14.0	11.5
18.0				17.7	17.6	17.1	17.7	15.8	14.9	13.7	11.0
20.0					15.0	15.5	15.0	14.8	14.4	13.2	10.4
22.0					12.9	13.4	12.9	13.2	13.1	12.4	9.9
24.0						11.7	11.2	11.4	11.4	11.0	9.4
26.0						10.3	9.9	10.0	10.0	9.6	8.8
28.0						9.1	9.2	9.1	8.8	8.4	8.3
30.0							8.3	8.1	7.8	7.4	7.4
32.0							7.4	7.2	6.9	6.5	6.6
34.0								6.5	6.2	5.8	5.8
36.0								5.8	5.5	5.1	5.2
38.0									5.0	4.6	4.6
40.0									4.4	4.0	4.1
42.0										3.6	3.6
44.0										3.2	3.2
46.0										2.8	2.8
48.0											2.5

 %	I	II	III	IV								
	0	0	46/0/0	92/0/0/0	92/46/0/0	92/46/0/0	92/46/0	92/46/0	92/46/0	92/46	92	100
	0	0	0/0/0	0/46/0/0	46/46/46/0	46/46/46/0	92/46/46	92/46/92	92/92	92/92	92	100
	0	0	0/46/0	0/46/46/0	0/46/46/46	46/46/46/92	46/46/92	92/92/92	92/92	92/92	92	100
	0	0	0/0/46	0/0/46/92	0/0/46/92	0/46/92/92	0/92/92	0/92/92	46/92	92	92	100

* Nach hinten / * Over rear / * A l'arrière / * Sobre la parte trasera

** Mit Zusatzhubausrüstung / ** With additional lifting equipment / ** Avec équipement supplémentaire / ** Con equipo adicional

Hubhöhen
Lifting heights
Hauteurs de levage
Alturas de elevación

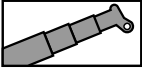

35t

DIN/ISO

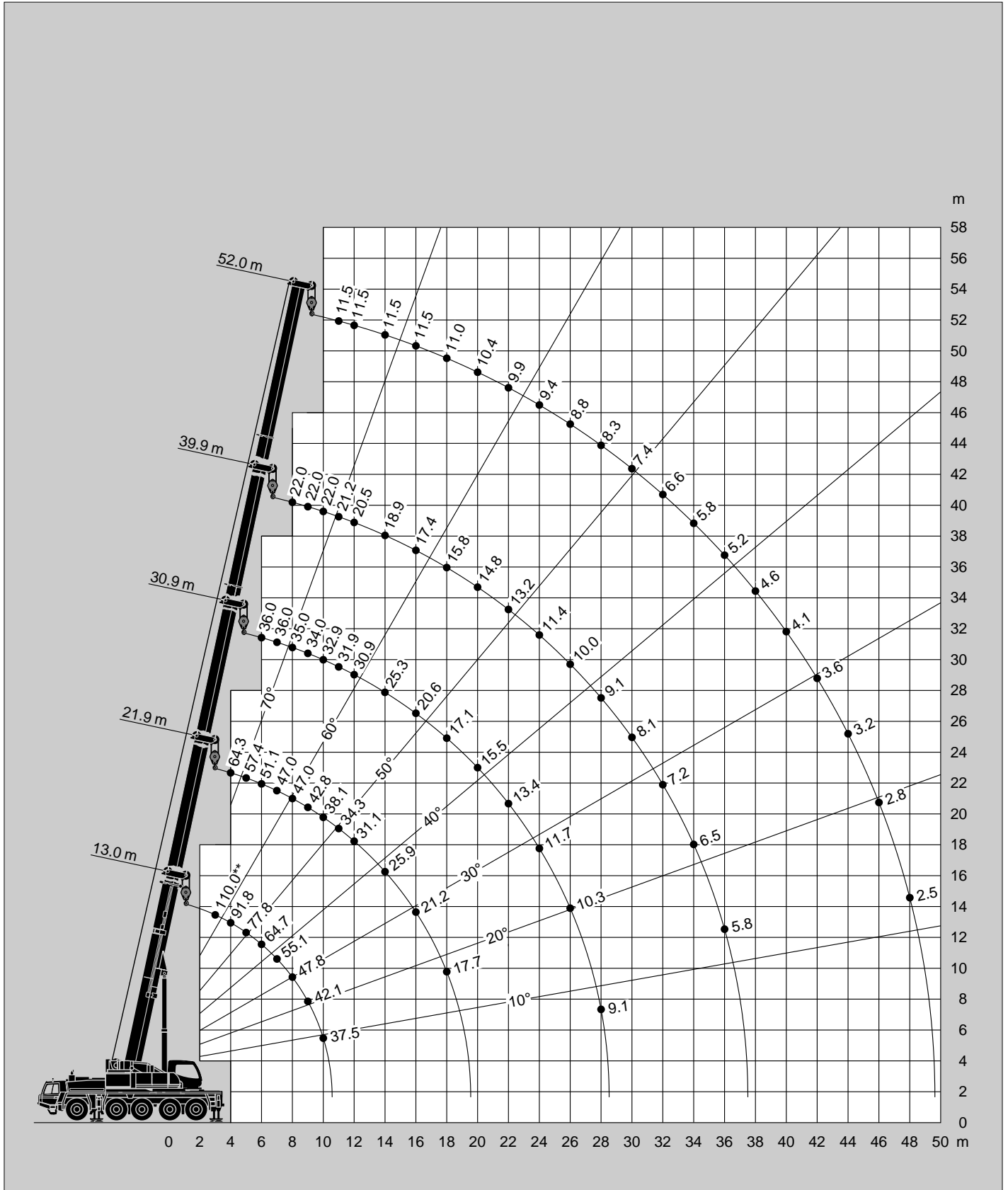

** Mit Zusatzhubausrüstung / ** With additional lifting equipment / ** Avec équipement supplémentaire / ** Con equipo adicional

Tragfähigkeiten
Lifting capacities
Capacités de levage
Capacidades de elevación

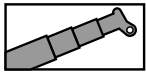

28.8t

DIN/ISO

 m	13.0 m*	13.0 m	17.4 m	21.9 m	26.4 m	30.9 m	35.4 m	39.9 m	44.4 m	48.9 m	52.0 m
3.0	110.0**	95.0**	80.0	67.0							
3.5	98.9**	87.0	80.0	65.6							
4.0	91.8	80.3	77.6	64.3	50.0						
4.5	83.3	74.4	73.9	60.9	48.9						
5.0	75.1	69.3	68.8	57.4	47.8	36.0					
6.0	62.4	60.8	60.3	51.1	45.7	36.0	28.0				
7.0	53.1	53.1	52.3	47.0	43.3	36.0	28.0	22.0			
8.0	46.1	46.1	46.7	46.8	41.4	35.0	28.0	22.0	18.0		
9.0	40.5	40.5	41.2	41.2	39.6	34.0	26.9	22.0	18.0	14.0	
10.0	36.0	36.0	36.7	36.7	36.9	32.9	25.8	22.0	18.0	14.0	11.5
11.0			32.7	32.8	33.7	31.9	24.7	21.2	18.0	14.0	11.5
12.0			28.6	29.8	29.7	29.1	23.6	20.5	18.0	14.0	11.5
14.0			23.0	23.6	23.5	22.9	21.7	18.9	16.9	14.0	11.5
16.0				19.2	19.1	18.8	19.2	17.4	15.9	14.0	11.5
18.0				16.0	15.9	16.5	16.0	15.6	14.9	13.7	11.0
20.0					13.4	14.0	13.5	13.7	13.6	13.2	10.4
22.0					11.9	12.1	11.7	11.9	11.7	11.3	9.9
24.0						10.5	10.7	10.4	10.1	9.7	9.4
26.0						9.2	9.4	9.1	8.8	8.4	8.5
28.0						8.1	8.3	8.0	7.8	7.4	7.4
30.0							7.3	7.1	6.8	6.4	6.5
32.0							6.5	6.3	6.0	5.6	5.7
34.0								5.6	5.4	5.0	5.0
36.0								5.0	4.7	4.4	4.4
38.0									4.2	3.8	3.8
40.0									3.7	3.3	3.4
42.0										2.9	2.9
44.0										2.5	2.6
46.0										2.2	2.2
48.0											1.9

 %	I	II	III	IV								
	0	0	46/0/0	92/0/0/0	92/46/0/0	92/46/0/0	92/46/0	92/46/0	92/46/0	92/46	92	100
	0	0	0/0/0	0/46/0/0	46/46/46/0	46/46/46/0	92/46/46	92/46/92	92/92	92/92	92	100
	0	0	0/46/0	0/46/46/0	0/46/46/46	46/46/46/92	46/46/92	92/92/92	92/92	92/92	92	100
	0	0	0/0/46	0/0/46/92	0/0/46/92	0/46/92/92	0/92/92	0/92/92	46/92	92	92	100

* Nach hinten / * Over rear / * A l'arrière / * Sobre la parte trasera

** Mit Zusatzhubausrüstung / ** With additional lifting equipment / ** Avec équipement supplémentaire / ** Con equipo adicional

Hubhöhen
Lifting heights
Hauteurs de levage
Alturas de elevación

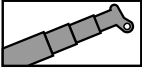

28.8 t

DIN/ISO

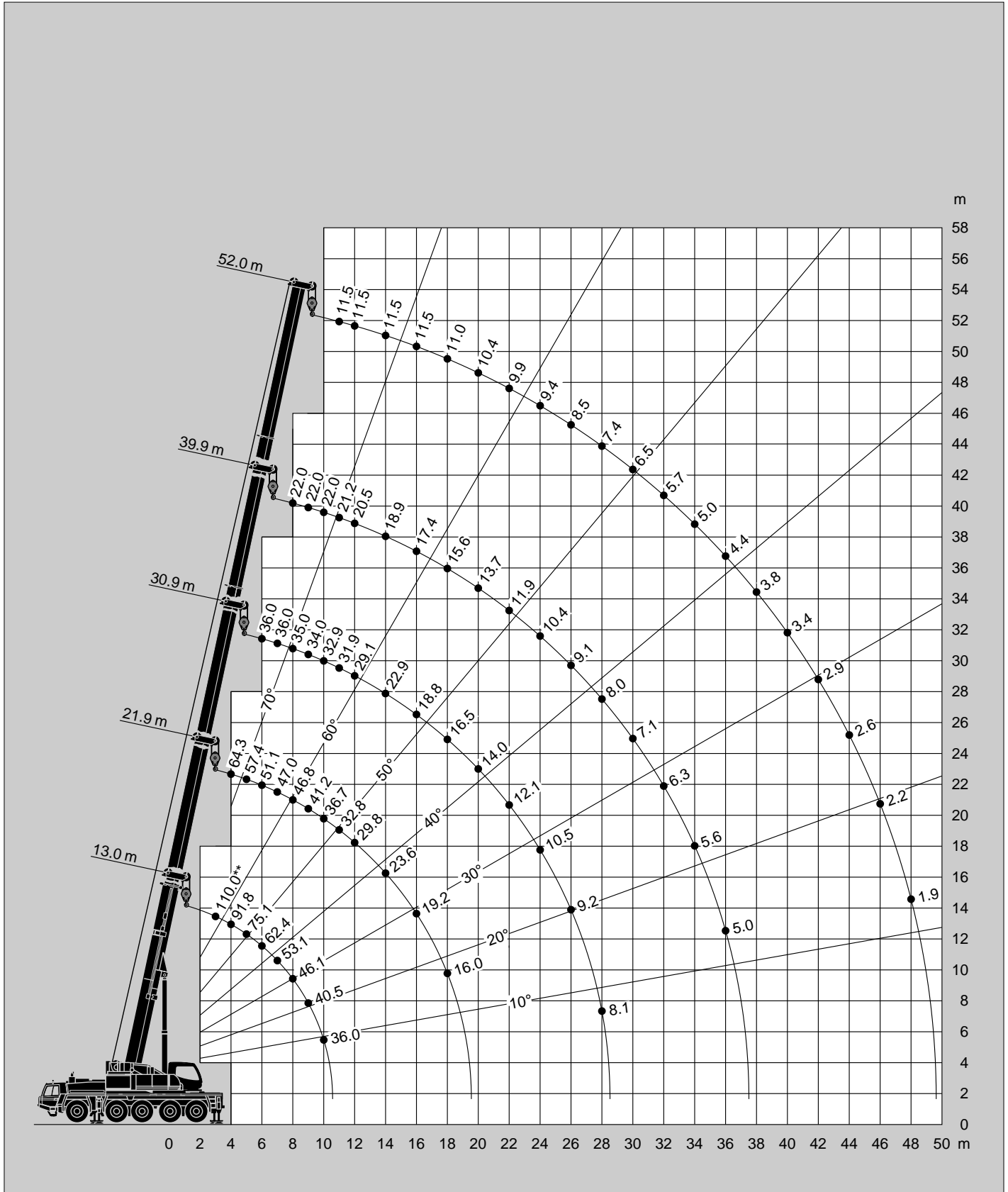

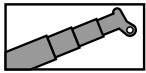

** Mit Zusatzhubausrüstung / ** With additional lifting equipment / ** Avec équipement supplémentaire / ** Con equipo adicional

Tragfähigkeiten
Lifting capacities
Capacités de levage
Capacidades de elevación



20.8t

DIN/ISO

 m	13.0 m*	13.0 m	17.4 m	21.9 m	26.4 m	30.9 m	35.4 m	39.9 m	44.4 m	48.9 m	52.0 m	
3.0	110.0**	95.0**	80.0	67.0								
3.5	98.9**	84.1	80.0	65.6								
4.0	88.3	77.6	77.1	64.3	50.0							
4.5	78.7	72.0	71.5	60.9	48.9							
5.0	70.8	67.1	66.5	57.4	47.8	36.0						
6.0	58.8	58.8	58.0	51.1	45.7	36.0	28.0					
7.0	50.1	50.1	49.3	47.0	43.3	36.0	28.0	22.0				
8.0	43.4	43.4	44.0	44.1	41.4	35.0	28.0	22.0	18.0			
9.0	37.6	37.6	38.6	38.8	38.2	34.0	26.9	22.0	18.0	14.0		
10.0	31.4	31.4	32.4	33.7	33.6	32.9	25.8	22.0	18.0	14.0	11.5	
11.0			28.3	28.9	28.9	28.2	24.7	21.2	18.0	14.0	11.5	
12.0			24.7	25.4	25.3	24.7	23.4	20.5	18.0	14.0	11.5	
14.0			19.3	19.9	19.8	20.5	19.9	18.6	16.9	14.0	11.5	
16.0				16.1	16.0	16.7	16.1	16.3	15.4	14.0	11.5	
18.0				13.3	14.0	13.8	14.0	13.8	13.5	13.0	11.0	
20.0					11.8	11.7	11.8	11.6	11.3	10.9	10.4	
22.0					10.1	10.0	10.1	9.9	9.6	9.2	9.2	
24.0						8.8	8.8	8.5	8.2	7.8	7.9	
26.0						7.6	7.6	7.4	7.1	6.7	6.7	
28.0						6.7	6.7	6.4	6.1	5.7	5.8	
30.0							5.8	5.6	5.3	4.9	4.9	
32.0							5.1	4.9	4.6	4.2	4.2	
34.0								4.3	4.0	3.6	3.6	
36.0								3.7	3.5	3.1	3.1	
38.0									3.0	2.6	2.6	
40.0									2.6	2.2	2.2	
42.0										1.8	1.8	
44.0										1.5	1.5	
46.0										1.2	1.2	
48.0											0.9	
 %	I	0	0	46/0/0	92/0/0/0	92/46/0/0	92/46/0/0	92/46/0	92/46/0	92/46	92	100
	II	0	0	0/0/0	0/46/0/0	46/46/46/0	46/46/46/0	92/46/46	92/46/92	92/92	92	100
	III	0	0	0/46/0	0/46/46/0	0/46/46/46	46/46/46/92	46/46/92	92/92/92	92/92	92	100
	IV	0	0	0/0/46	0/0/46/92	0/0/46/92	0/46/92/92	0/92/92	0/92/92	46/92	92	100

* Nach hinten / * Over rear / * A l'arrière / * Sobre la parte trasera

** Mit Zusatzhubausrüstung / ** With additional lifting equipment / ** Avec équipement supplémentaire / ** Con equipo adicional

Hubhöhen
Lifting heights
Hauteurs de levage
Alturas de elevación

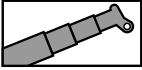

20.8 t

DIN/ISO

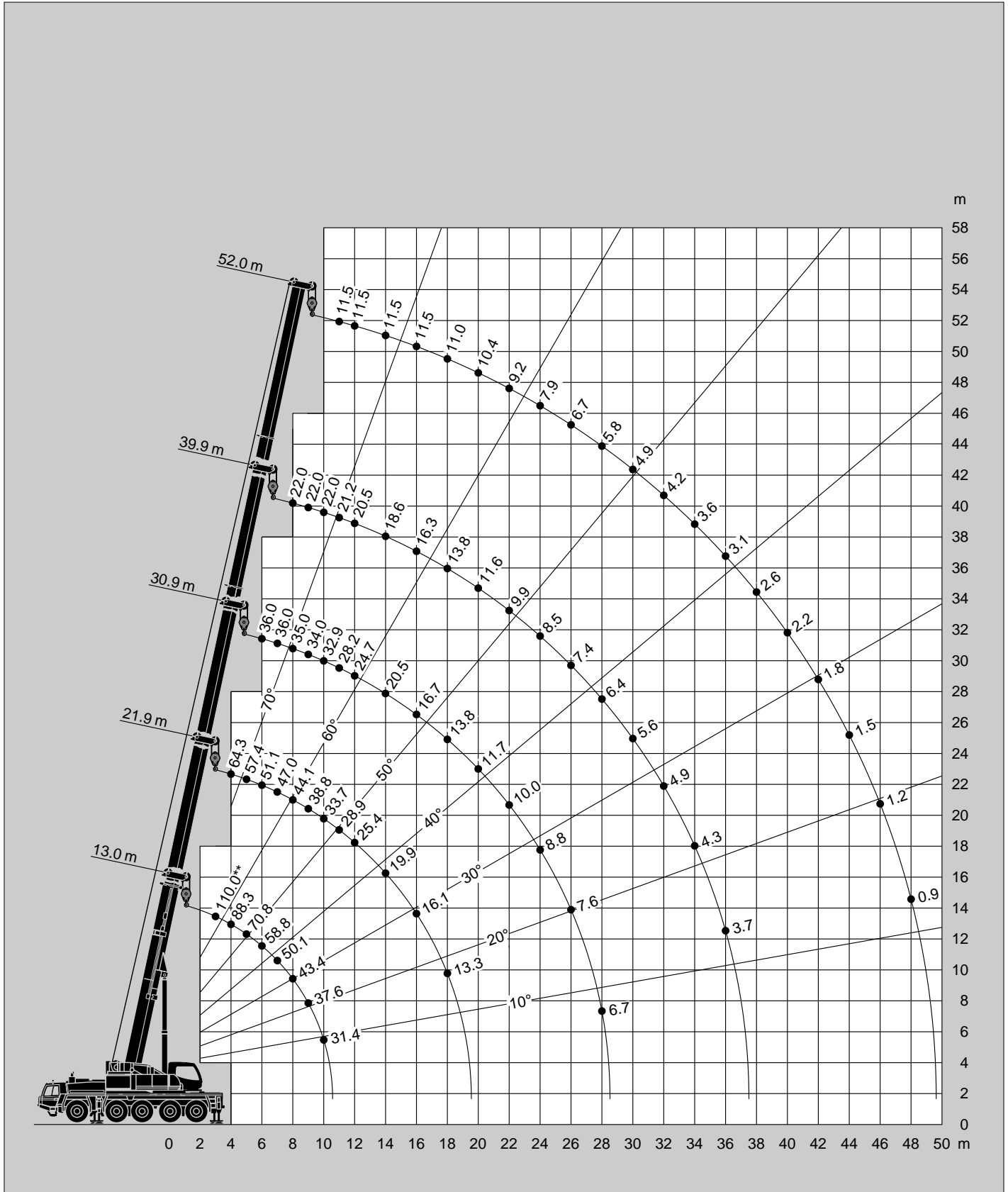

** Mit Zusatzhubausrüstung / ** With additional lifting equipment / ** Avec équipement supplémentaire / ** Con equipo adicional

Tragfähigkeiten
Lifting capacities
Capacités de levage
Capacidades de elevación

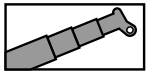

m	13.0 m*	13.0 m	17.4 m	21.9 m	26.4 m	30.9 m	35.4 m	39.9 m	44.4 m	48.9 m	52.0 m	
3.0	110.0**	95.0**	80.0	67.0								
3.5	93.3	83.7	80.0	65.6								
4.0	82.0	77.1	76.6	64.3	50.0							
4.5	73.1	71.5	71.0	60.9	48.9							
5.0	65.7	65.7	64.8	57.4	47.8	36.0						
6.0	54.5	54.5	53.7	51.1	45.7	36.0	28.0					
7.0	46.3	46.3	47.0	47.0	43.3	36.0	28.0	22.0				
8.0	36.6	36.6	37.7	39.2	39.1	35.0	28.0	22.0	18.0			
9.0	29.6	29.6	31.2	32.0	31.9	31.2	26.9	22.0	18.0	14.0		
10.0	24.5	24.5	26.1	26.8	26.7	26.1	24.7	22.0	18.0	14.0	11.5	
11.0			22.2	22.9	22.8	23.5	22.9	21.2	18.0	14.0	11.5	
12.0			19.3	20.0	20.5	20.6	20.0	18.5	18.0	14.0	11.5	
14.0			14.9	15.7	16.2	16.1	16.3	16.0	15.6	14.0	11.5	
16.0				12.4	13.0	13.0	13.0	12.7	12.4	11.9	11.5	
18.0				10.0	10.5	10.6	10.6	10.3	10.0	9.5	9.6	
20.0					8.7	8.8	8.7	8.5	8.2	7.7	7.8	
22.0					7.3	7.3	7.3	7.1	6.8	6.3	6.4	
24.0						6.2	6.2	5.9	5.7	5.2	5.3	
26.0						5.2	5.2	5.0	4.7	4.3	4.3	
28.0						4.5	4.5	4.2	4.0	3.5	3.6	
30.0							3.8	3.6	3.3	2.9	2.9	
32.0							3.2	3.0	2.7	2.3	2.4	
34.0								2.5	2.3	1.9	1.9	
36.0								2.1	1.8	1.4	1.5	
38.0									1.5	1.1	1.1	
40.0									1.1			
%	I	0	0	46/0/0	92/0/0/0	92/46/0/0	92/46/0/0	92/46/0	92/46/0	92/46	92	100
	II	0	0	0/0/0	0/46/0/0	46/46/46/0	46/46/46/0	92/46/46	92/46/92	92/92	92	100
	III	0	0	0/46/0	0/46/46/0	0/46/46/46	46/46/46/92	46/46/92	92/92/92	92/92	92	100
	IV	0	0	0/0/46	0/0/46/92	0/0/46/92	0/46/92/92	0/92/92	0/92/92	46/92	92	100

* Nach hinten / * Over rear / * A l'arrière / * Sobre la parte trasera

** Mit Zusatzhubausrüstung / ** With additional lifting equipment / ** Avec équipement supplémentaire / ** Con equipo adicional

Hubhöhen
Lifting heights
Hauteurs de levage
Alturas de elevación

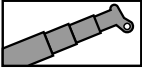

11t

DIN/ISO

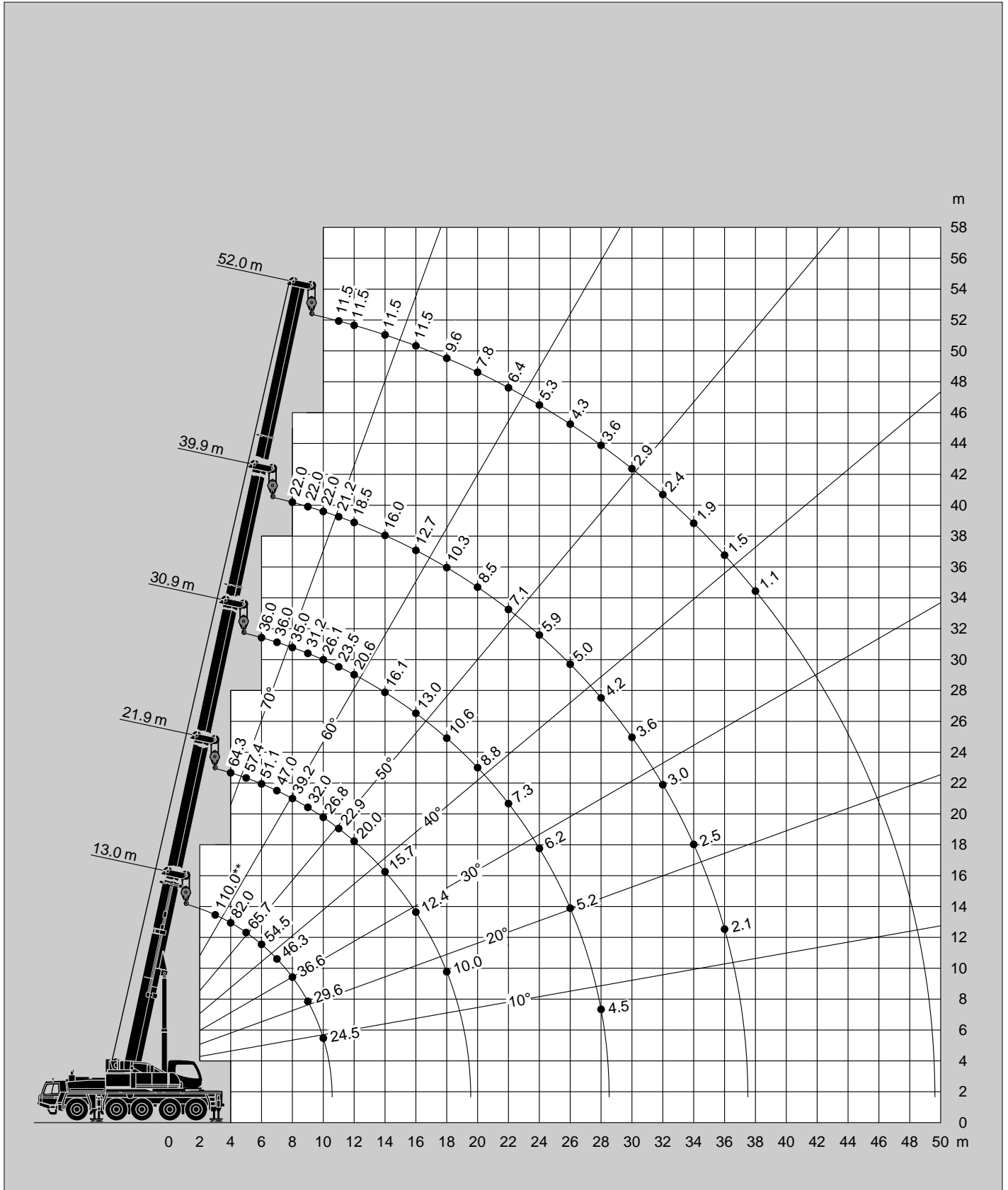

** Mit Zusatzhubausrüstung / ** With additional lifting equipment / ** Avec équipement supplémentaire / ** Con equipo adicional

Tragfähigkeiten
Lifting capacities
Capacités de levage
Capacidades de elevación

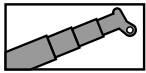

8.7t

DIN/ISO

 m	13.0 m*	13.0 m	17.4 m	21.9 m	26.4 m	30.9 m	35.4 m	39.9 m	44.4 m	48.9 m	52.0 m
3.0	110.0**	95.0	80.0	67.0							
3.5	91.7	85.9	80.0	65.6							
4.0	80.5	79.3	77.6	64.3	50.0						
4.5	71.7	71.7	70.8	60.9	48.9						
5.0	64.5	64.5	63.6	57.4	47.8	36.0					
6.0	53.5	53.5	52.6	51.1	45.7	36.0	28.0				
7.0	44.2	44.2	45.3	45.7	43.3	36.0	28.0	22.0			
8.0	34.3	34.3	35.1	36.9	36.8	35.0	28.0	22.0	18.0		
9.0	27.6	27.6	29.3	30.1	30.0	29.3	26.9	22.0	18.0	14.0	
10.0	22.9	22.9	24.5	25.1	25.1	24.6	24.0	22.0	18.0	14.0	11.5
11.0			20.8	21.5	22.2	22.1	21.5	19.9	18.0	14.0	11.5
12.0			18.0	18.6	19.4	19.3	18.6	17.9	17.8	14.0	11.5
14.0			13.7	14.5	15.1	15.1	15.1	14.8	14.5	13.9	11.5
16.0				11.4	11.9	12.0	12.0	11.7	11.4	10.9	10.9
18.0				9.1	9.6	9.7	9.7	9.4	9.1	8.6	8.7
20.0					7.9	8.0	8.0	7.7	7.4	7.0	7.0
22.0					6.6	6.6	6.6	6.4	6.1	5.6	5.7
24.0						5.6	5.6	5.3	5.0	4.6	4.6
26.0						4.7	4.7	4.4	4.2	3.7	3.8
28.0						4.0	3.9	3.7	3.4	3.0	3.0
30.0							3.3	3.1	2.8	2.4	2.4
32.0							2.8	2.6	2.3	1.9	1.9
34.0								2.1	1.8	1.4	1.5
36.0								1.7	1.4		
38.0									1.1		

 %	I	II	III	IV								
I	0	0	46/0/0	92/0/0/0	92/46/0/0	92/46/0/0	92/46/0	92/46/0	92/46/0	92/46	92	100
II	0	0	0/0/0	0/46/0/0	46/46/46/0	46/46/46/0	92/46/46	92/46/92	92/92	92/92	92	100
III	0	0	0/46/0	0/46/46/0	0/46/46/46	46/46/46/92	46/46/92	92/92/92	92/92	92/92	92	100
IV	0	0	0/0/46	0/0/46/92	0/0/46/92	0/46/92/92	0/92/92	0/92/92	46/92	92	92	100

* Nach hinten / * Over rear / * A l'arrière / * Sobre la parte trasera

** Mit Zusatzhubausrüstung / ** With additional lifting equipment / ** Avec équipement supplémentaire / ** Con equipo adicional

Hubhöhen
Lifting heights
Hauteurs de levage
Alturas de elevación

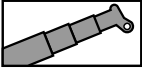

8.7t

DIN/ISO

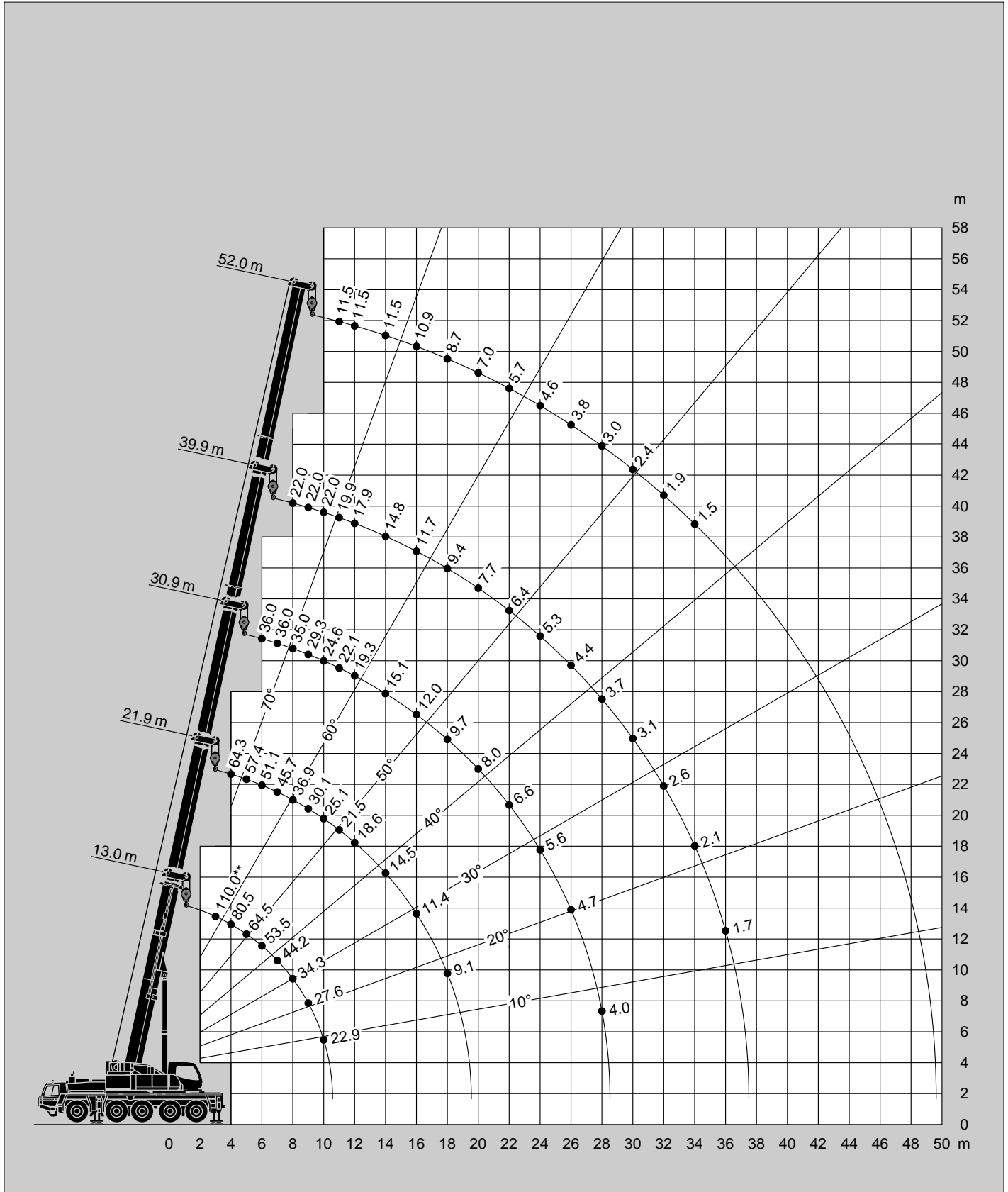

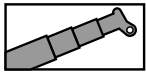

** Mit Zusatzhubausrüstung / ** With additional lifting equipment / ** Avec équipement supplémentaire / ** Con equipo adicional

Tragfähigkeiten
Lifting capacities
Capacités de levage
Capacidades de elevación



DIN/ISO

 m	13.0 m*	13.0 m	17.4 m	21.9 m	26.4 m	30.9 m	35.4 m	39.9 m	44.4 m	48.9 m	52.0 m	
3.0	98.5**	90.5	80.0	67.0								
3.5	85.3	83.0	80.0	65.6								
4.0	74.9	74.9	73.9	64.3	50.0							
4.5	66.6	66.6	65.7	60.9	48.9							
5.0	59.9	59.9	59.0	57.4	47.8	36.0						
6.0	46.5	46.5	47.0	47.0	45.1	36.0	28.0					
7.0	33.5	33.5	35.6	36.5	36.4	35.0	28.0	22.0				
8.0	25.7	25.6	27.5	28.4	28.3	27.5	25.8	22.0	18.0			
9.0	20.5	20.1	22.0	22.8	23.7	23.5	22.8	20.9	18.0	14.0		
10.0	16.8	16.0	17.7	18.7	19.4	19.5	18.8	18.6	17.5	14.0	11.5	
11.0			14.6	15.6	16.3	16.3	16.3	16.0	15.6	14.0	11.5	
12.0			12.4	13.3	13.9	14.0	14.0	13.7	13.3	12.7	11.5	
14.0			9.0	9.8	10.4	10.5	10.5	10.2	9.8	9.3	9.4	
16.0				7.4	8.0	8.1	8.1	7.8	7.4	7.0	7.0	
18.0				5.7	6.2	6.3	6.3	6.0	5.6	5.2	5.2	
20.0					4.9	4.9	4.9	4.6	4.3	3.8	3.9	
22.0					3.8	3.8	3.8	3.6	3.3	2.8	2.9	
24.0						3.0	3.0	2.8	2.5	2.0	2.0	
26.0						2.3	2.3	2.1	1.8	1.4	1.4	
28.0						1.8	1.8	1.5	1.2			
30.0							1.3	1.1				
 %	I	0	0	46/0/0	92/0/0/0	92/46/0/0	92/46/0/0	92/46/0	92/46/0	92/46	92	100
	II	0	0	0/0/0	0/46/0/0	46/46/46/0	46/46/46/0	92/46/46	92/46/92	92/92	92	100
	III	0	0	0/46/0	0/46/46/0	0/46/46/46	46/46/46/92	46/46/92	92/92/92	92/92	92	100
	IV	0	0	0/0/46	0/0/46/92	0/0/46/92	0/46/92/92	0/92/92	0/92/92	46/92	92	100

* Nach hinten / * Over rear / * A l'arrière / * Sobre la parte trasera

** Mit Zusatzhubausrüstung / ** With additional lifting equipment / ** Avec équipement supplémentaire / ** Con equipo adicional

Hubhöhen
Lifting heights
Hauteurs de levage
Alturas de elevación

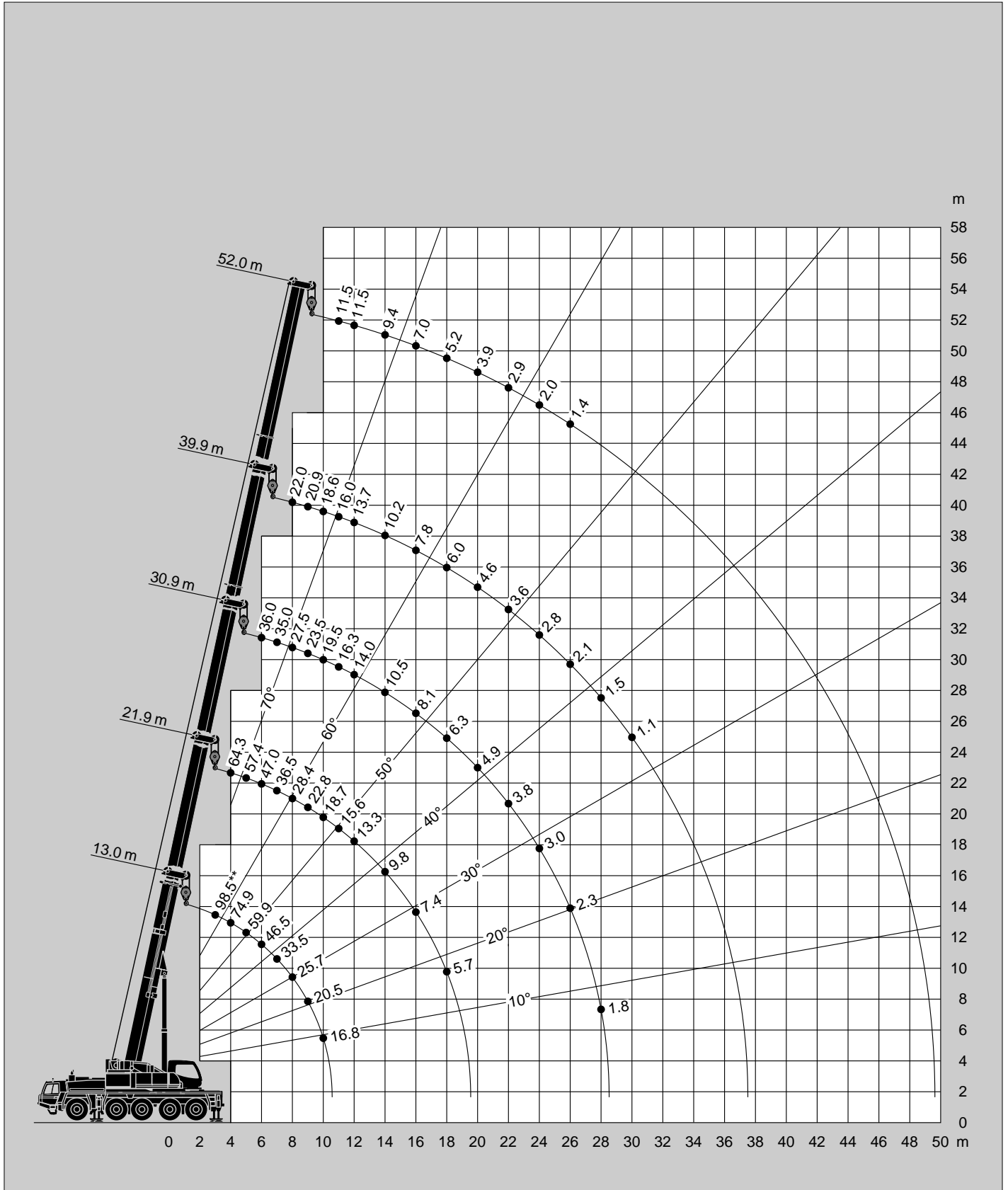
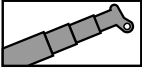

** Mit Zusatzhubausrüstung / ** With additional lifting equipment / ** Avec équipement supplémentaire / ** Con equipo adicional

Tragfähigkeiten
Lifting capacities
Capacités de levage
Capacidades de elevación

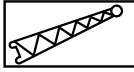
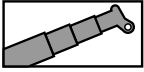

35t

DIN/ISO

m	52.0 m + 9.5 m			52.0 m + 16.2 m			52.0 m + 24.1 m			52.0 m + 30.1 m		
	0°	20°	35°	0°	20°	35°	0°	20°	35°	0°	20°	35°
10.0	6.00											
11.0	6.00											
12.0	6.00											
14.0	6.00	6.00		4.50								
16.0	6.00	6.00	5.40	4.50			3.00			2.10		
18.0	6.00	6.00	5.20	4.50	4.00		3.00			2.10		
20.0	6.00	6.00	5.00	4.50	4.00		3.00	2.80		2.10		
22.0	6.00	5.90	4.90	4.50	3.80	2.55	3.00	2.60		2.10	2.00	
24.0	6.00	5.65	4.70	4.50	3.60	2.45	3.00	2.45		2.10	1.90	
26.0	5.55	5.25	4.60	4.50	3.40	2.35	2.90	2.35		2.10	1.75	
28.0	5.10	4.85	4.40	4.40	3.30	2.30	2.85	2.20	1.65	2.05	1.65	
30.0	4.70	4.50	4.30	4.20	3.10	2.20	2.75	2.10	1.60	2.05	1.55	1.10
32.0	4.30	4.15	4.10	3.85	3.00	2.15	2.60	2.00	1.50	2.00	1.50	1.05
34.0	3.95	3.85	3.80	3.60	2.85	2.10	2.40	1.90	1.50	1.85	1.40	1.00
36.0	3.65	3.55	3.55	3.35	2.70	2.05	2.25	1.80	1.45	1.70	1.30	1.00
38.0	3.40	3.30	3.30	3.10	2.60	2.00	2.10	1.75	1.40	1.60	1.25	0.95
40.0	3.15	3.05	3.05	2.90	2.50	1.95	2.00	1.65	1.35	1.50	1.20	0.90
42.0	2.90	2.85	2.85	2.70	2.40	1.90	1.90	1.60	1.35	1.40	1.15	0.90
44.0	2.70	2.65	2.65	2.50	2.35	1.85	1.75	1.50	1.30	1.30	1.10	0.85
46.0	2.50	2.50	2.50	2.30	2.25	1.85	1.70	1.45	1.25	1.25	1.00	0.85
48.0	2.20	2.30	2.35	2.15	2.15	1.80	1.60	1.40	1.25	1.15	1.00	0.80
50.0	1.90	2.00	2.00	2.00	2.00	1.80	1.50	1.35	1.20	1.10	0.95	0.80
52.0	1.60	1.70	1.70	1.85	1.85	1.75	1.45	1.30	1.20	1.00	0.90	
54.0	1.30	1.30	1.30	1.75	1.75	1.70	1.35	1.25	1.20	0.95	0.85	
56.0	1.00	1.10	1.00	1.50	1.65	1.65	1.30	1.20	1.15	0.90	0.80	
58.0				1.30	1.40	1.40	1.25	1.20	1.15	0.85	0.80	
60.0				1.10	1.20	1.10	1.15	1.15	1.10	0.80		
62.0							1.05	1.10	1.00			
64.0							0.95	1.05	0.90			

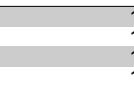
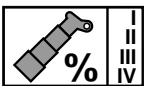

100

100

100

100

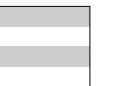
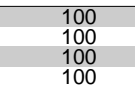
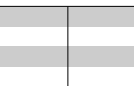
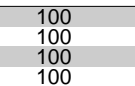
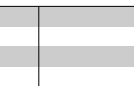
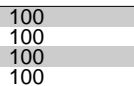

DIN/ISO

m	48.9 m + 9.5 m			48.9 m + 16.2 m			48.9 m + 24.1 m			48.9 m + 30.1 m		
	0°	20°	35°	0°	20°	35°	0°	20°	35°	0°	20°	35°
10.0	7.00											
11.0	7.00											
12.0	7.00	7.00										
14.0	7.00	7.00		5.10			3.20					
16.0	7.00	6.80	5.30	5.10	4.50		3.20			2.30		
18.0	7.00	6.60	5.10	5.10	4.50		3.20	2.90		2.30		
20.0	7.00	6.40	4.90	5.10	4.40	3.00	3.20	2.75		2.30		
22.0	7.00	6.20	4.80	5.10	4.20	2.90	3.20	2.55		2.30	2.00	
24.0	6.60	5.90	4.60	5.10	4.00	2.80	3.10	2.40		2.30	1.85	
26.0	6.25	5.60	4.50	5.00	3.80	2.70	2.95	2.25	1.65	2.20	1.75	
28.0	5.90	5.30	4.40	4.80	3.60	2.60	2.85	2.15	1.60	2.15	1.60	
30.0	5.60	5.10	4.30	4.70	3.40	2.55	2.65	2.05	1.55	2.05	1.55	1.10
32.0	5.35	4.90	4.20	4.40	3.30	2.45	2.45	1.95	1.50	1.90	1.45	1.05
34.0	5.10	4.70	4.10	4.10	3.10	2.40	2.30	1.85	1.45	1.75	1.35	1.00
36.0	4.85	4.50	4.00	3.90	3.00	2.35	2.15	1.75	1.40	1.65	1.30	0.95
38.0	4.40	4.30	3.90	3.70	2.90	2.30	2.00	1.65	1.35	1.50	1.20	0.95
40.0	3.90	4.10	3.80	3.50	2.75	2.25	1.90	1.60	1.35	1.40	1.15	0.90
42.0	3.40	3.60	3.70	3.30	2.65	2.20	1.80	1.55	1.30	1.30	1.10	0.85
44.0	3.00	3.10	3.20	3.10	2.55	2.15	1.70	1.45	1.25	1.25	1.05	0.85
46.0	2.60	2.70	2.80	3.00	2.50	2.15	1.60	1.40	1.25	1.15	1.00	0.80
48.0	2.20	2.30	2.30	2.70	2.40	2.10	1.50	1.35	1.20	1.10	0.95	0.80
50.0	1.90	2.00	2.00	2.40	2.35	2.10	1.40	1.30	1.20	1.00	0.90	
52.0	1.60	1.60	1.60	2.10	2.30	2.05	1.35	1.25	1.20	0.95	0.85	
54.0	1.30	1.30	1.20	1.90	2.00	2.00	1.30	1.20	1.15	0.90	0.80	
56.0	1.10	1.00		1.60	1.70	1.70	1.20	1.15	1.15	0.85	0.80	
58.0				1.40	1.40	1.40	1.15	1.15	1.10	0.80		
60.0				1.10	1.10	1.00	1.10	1.10	1.05			
62.0							1.00	1.05	1.00			

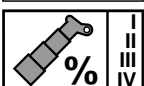

92

92

92

92

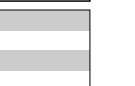
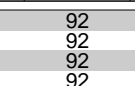
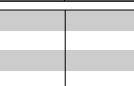
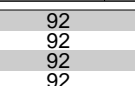
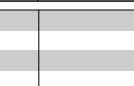
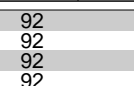

92

92

92

92

Hubhöhen
Lifting heights
Hauteurs de levage
Alturas de elevación

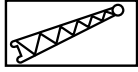
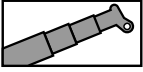

35t

DIN/ISO

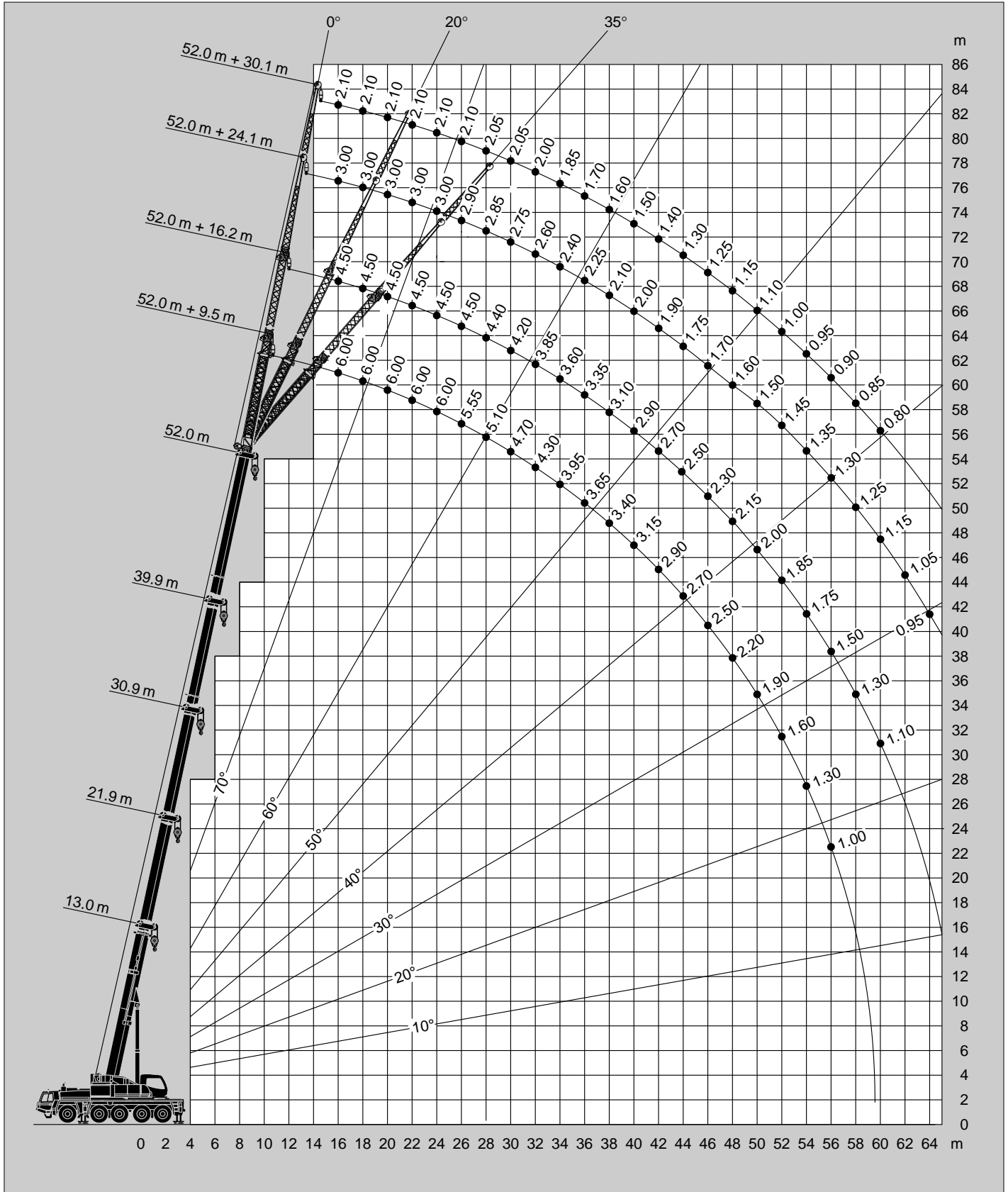

Tragfähigkeiten
Lifting capacities
Capacités de levage
Capacidades de elevación

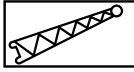
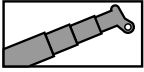

28.8t

DIN/ISO

m	52.0 m + 9.5 m			52.0 m + 16.2 m			52.0 m + 24.1 m			52.0 m + 30.1 m		
	0°	20°	35°	0°	20°	35°	0°	20°	35°	0°	20°	35°
10.0	6.00											
11.0	6.00											
12.0	6.00											
14.0	6.00	6.00		4.50								
16.0	6.00	6.00	5.40	4.50			3.00			2.10		
18.0	6.00	6.00	5.20	4.50	4.00		3.00			2.10		
20.0	6.00	6.00	5.00	4.50	4.00		3.00	2.80		2.10		
22.0	6.00	5.90	4.90	4.50	3.80	2.55	3.00	2.60		2.10	2.00	
24.0	6.00	5.65	4.70	4.50	3.60	2.45	3.00	2.45		2.10	1.90	
26.0	5.55	5.25	4.60	4.50	3.40	2.35	2.90	2.35		2.10	1.75	
28.0	5.10	4.85	4.40	4.40	3.30	2.30	2.85	2.20	1.65	2.05	1.65	
30.0	4.70	4.50	4.30	4.20	3.10	2.20	2.75	2.10	1.60	2.05	1.55	1.10
32.0	4.30	4.15	4.10	3.85	3.00	2.15	2.60	2.00	1.50	2.00	1.50	1.05
34.0	3.95	3.85	3.80	3.60	2.85	2.10	2.40	1.90	1.50	1.85	1.40	1.00
36.0	3.65	3.55	3.55	3.35	2.70	2.05	2.25	1.80	1.45	1.70	1.30	1.00
38.0	3.40	3.30	3.30	3.10	2.60	2.00	2.10	1.75	1.40	1.60	1.25	0.95
40.0	3.00	3.05	3.05	2.90	2.50	1.95	2.00	1.65	1.35	1.50	1.20	0.90
42.0	2.60	2.80	2.85	2.70	2.40	1.90	1.90	1.60	1.35	1.40	1.15	0.90
44.0	2.20	2.40	2.40	2.50	2.35	1.85	1.75	1.50	1.30	1.30	1.10	0.85
46.0	1.80	2.00	2.00	2.30	2.25	1.85	1.70	1.45	1.25	1.25	1.00	0.85
48.0	1.50	1.60	1.70	2.00	2.15	1.80	1.60	1.40	1.25	1.15	1.00	0.80
50.0	1.20	1.30	1.30	1.70	1.90	1.80	1.50	1.35	1.20	1.10	0.95	0.80
52.0		1.00	1.00	1.40	1.60	1.70	1.45	1.30	1.20	1.00	0.90	
54.0				1.20	1.30	1.40	1.35	1.25	1.20	0.95	0.85	
56.0					1.10	1.10	1.20	1.20	1.15	0.90	0.80	
58.0							1.00	1.20	1.15	0.85	0.80	
60.0								1.00	1.10	0.80		

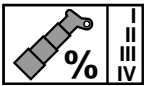

I
II
III
IV

100
100
100
100

100
100
100
100

100
100
100
100

100
100
100
100

100
100
100
100

100
100
100
100

100
100
100
100

100
100
100
100

100
100
100
100

100
100
100
100

100
100
100
100

100
100
100
100

100
100
100
100

100
100
100
100

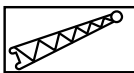
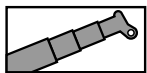

28.8t

DIN/ISO

m	48.9 m + 9.5 m			48.9 m + 16.2 m			48.9 m + 24.1 m			48.9 m + 30.1 m		
	0°	20°	35°	0°	20°	35°	0°	20°	35°	0°	20°	35°
10.0	7.00											
11.0	7.00											
12.0	7.00	7.00										
14.0	7.00	7.00		5.10			3.20					
16.0	7.00	6.80	5.30	5.10	4.50		3.20			2.30		
18.0	7.00	6.60	5.10	5.10	4.50		3.20	2.90		2.30		
20.0	7.00	6.40	4.90	5.10	4.40	3.00	3.20	2.75		2.30		
22.0	7.00	6.20	4.80	5.10	4.20	2.90	3.20	2.55		2.30	2.00	
24.0	6.60	5.90	4.60	5.10	4.00	2.80	3.10	2.40		2.30	1.85	
26.0	6.25	5.60	4.50	5.00	3.80	2.70	2.95	2.25	1.65	2.20	1.75	
28.0	5.90	5.30	4.40	4.80	3.60	2.60	2.85	2.15	1.60	2.15	1.60	
30.0	5.60	5.10	4.30	4.70	3.40	2.55	2.65	2.05	1.55	2.05	1.55	1.10
32.0	5.35	4.90	4.20	4.40	3.30	2.45	2.45	1.95	1.50	1.90	1.45	1.05
34.0	4.70	4.70	4.10	4.10	3.10	2.40	2.30	1.85	1.45	1.75	1.35	1.00
36.0	4.10	4.40	4.00	3.90	3.00	2.35	2.15	1.75	1.40	1.65	1.30	0.95
38.0	3.50	3.80	3.90	3.70	2.90	2.30	2.00	1.65	1.35	1.50	1.20	0.95
40.0	3.10	3.30	3.40	3.50	2.75	2.25	1.90	1.60	1.35	1.40	1.15	0.90
42.0	2.60	2.80	2.90	3.20	2.65	2.20	1.80	1.55	1.30	1.30	1.10	0.85
44.0	2.20	2.40	2.40	2.80	2.55	2.15	1.70	1.45	1.25	1.25	1.05	0.85
46.0	1.90	2.00	2.00	2.40	2.50	2.15	1.60	1.40	1.25	1.15	1.00	0.80
48.0	1.50	1.60	1.60	2.10	2.30	2.10	1.50	1.35	1.20	1.10	0.95	0.80
50.0	1.20	1.30	1.30	1.80	2.00	2.10	1.40	1.30	1.20	1.00	0.90	
52.0	1.00	1.00		1.50	1.70	1.70	1.35	1.25	1.20	0.95	0.85	
54.0				1.20	1.40	1.40	1.30	1.20	1.15	0.90	0.80	
56.0				1.00	1.10	1.10	1.20	1.15	1.15	0.85	0.80	
58.0							1.00	1.15	1.10	0.80		
60.0								1.00	1.05			

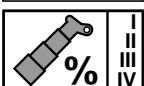

I
II
III
IV

92
92
92
92

92
92
92
92

92
92
92
92

92
92
92
92

92
92
92
92

92
92
92
92

92
92
92
92

92
92
92
92

92
92
92
92

92
92
92
92

92
92
92
92

92
92
92
92

92
92
92
92

92
92
92
92

Hubhöhen
Lifting heights
Hauteurs de levage
Alturas de elevación

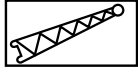
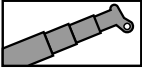

28.8t

DIN/ISO

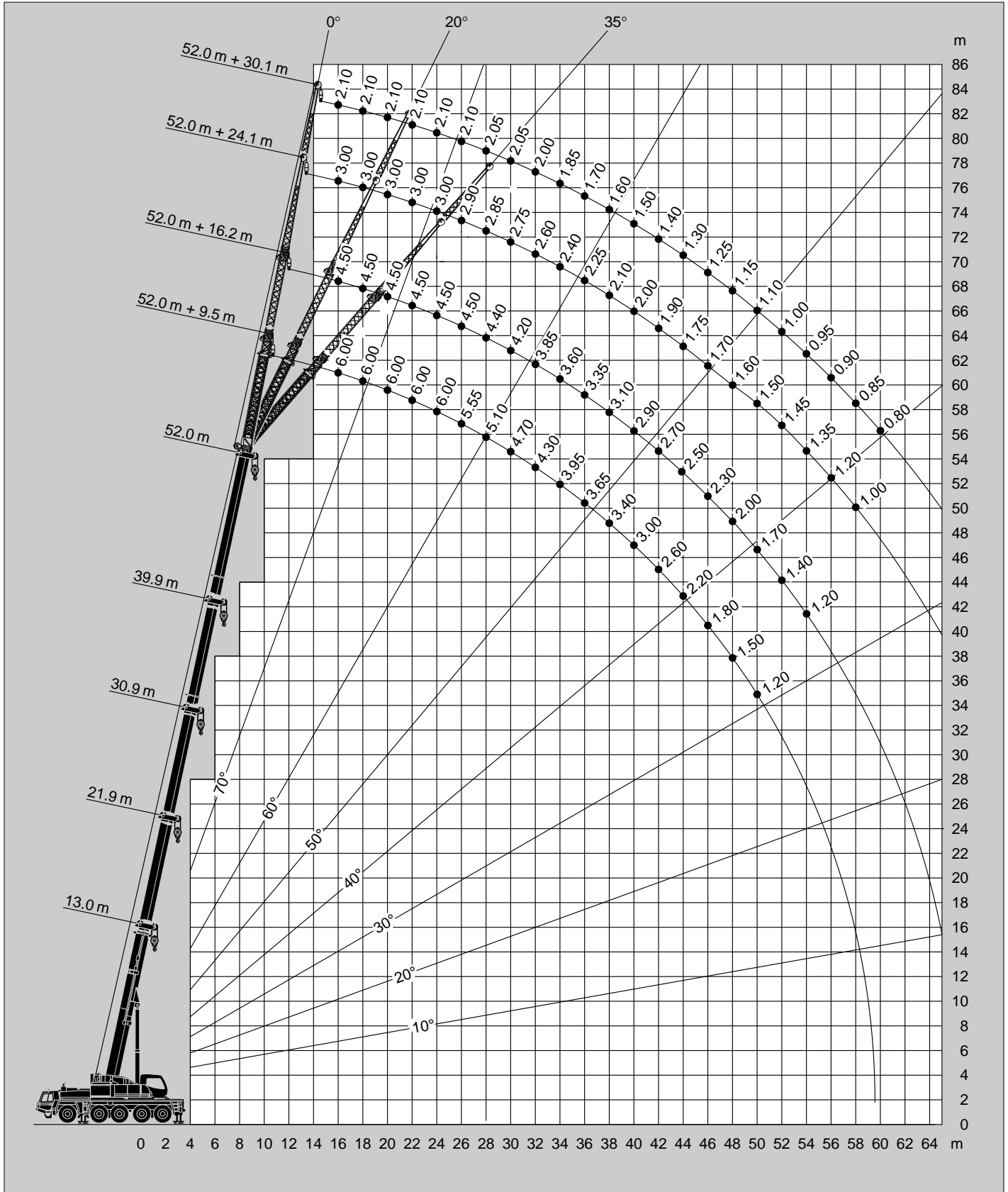

Tragfähigkeiten
Lifting capacities
Capacités de levage
Capacidades de elevación

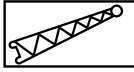
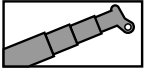

20.8t

DIN/ISO

m	52.0 m + 9.5 m			52.0 m + 16.2 m			52.0 m + 24.1 m			52.0 m + 30.1 m		
	0°	20°	35°	0°	20°	35°	0°	20°	35°	0°	20°	35°
10.0	6.00											
11.0	6.00											
12.0	6.00											
14.0	6.00	6.00		4.50								
16.0	6.00	6.00	5.40	4.50			3.00			2.10		
18.0	6.00	6.00	5.20	4.50	4.00		3.00			2.10		
20.0	6.00	6.00	5.00	4.50	4.00		3.00	2.80		2.10		
22.0	6.00	5.90	4.90	4.50	3.80	2.55	3.00	2.60		2.10	2.00	
24.0	6.00	5.65	4.70	4.50	3.60	2.45	3.00	2.45		2.10	1.90	
26.0	5.55	5.25	4.60	4.50	3.40	2.35	2.90	2.35		2.10	1.75	
28.0	5.10	4.85	4.40	4.40	3.30	2.30	2.85	2.20	1.65	2.05	1.65	
30.0	4.60	4.50	4.30	4.20	3.10	2.20	2.75	2.10	1.60	2.05	1.55	1.10
32.0	3.90	4.15	4.10	3.85	3.00	2.15	2.60	2.00	1.50	2.00	1.50	1.05
34.0	3.30	3.60	3.80	3.60	2.85	2.10	2.40	1.90	1.50	1.85	1.40	1.00
36.0	2.70	3.00	3.20	3.30	2.70	2.05	2.25	1.80	1.45	1.70	1.30	1.00
38.0	2.20	2.50	2.70	2.80	2.60	2.00	2.10	1.75	1.40	1.60	1.25	0.95
40.0	1.80	2.00	2.20	2.30	2.50	1.95	2.00	1.65	1.35	1.50	1.20	0.90
42.0	1.40	1.60	1.70	2.00	2.30	1.90	1.90	1.60	1.35	1.40	1.15	0.90
44.0	1.10	1.30	1.40	1.60	1.90	1.85	1.75	1.50	1.30	1.30	1.10	0.85
46.0	0.80	0.90	1.00	1.30	1.60	1.80	1.60	1.45	1.25	1.25	1.00	0.85
48.0				1.00	1.30	1.40	1.30	1.40	1.25	1.15	1.00	0.80
50.0				0.80	1.00	1.10	1.00	1.35	1.20	1.10	0.95	0.80
52.0						0.80	0.80	1.10	1.20	0.90	0.90	0.80
54.0								0.90	1.10		0.85	
56.0									0.80			

I	100	100	100	100
II	100	100	100	100
III	100	100	100	100
IV	100	100	100	100

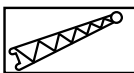
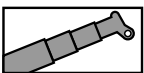

20.8t

DIN/ISO

m	48.9 m + 9.5 m			48.9 m + 16.2 m			48.9 m + 24.1 m			48.9 m + 30.1 m		
	0°	20°	35°	0°	20°	35°	0°	20°	35°	0°	20°	35°
10.0	7.00											
11.0	7.00											
12.0	7.00	7.00										
14.0	7.00	7.00		5.10			3.20					
16.0	7.00	6.80	5.30	5.10	4.50		3.20			2.30		
18.0	7.00	6.60	5.10	5.10	4.50		3.20	2.90		2.30		
20.0	7.00	6.40	4.90	5.10	4.40	3.00	3.20	2.75		2.30		
22.0	7.00	6.20	4.80	5.10	4.20	2.90	3.20	2.55		2.30	2.00	
24.0	6.60	5.90	4.60	5.10	4.00	2.80	3.10	2.40		2.30	1.85	
26.0	6.25	5.60	4.50	5.00	3.80	2.70	2.95	2.25	1.65	2.20	1.75	
28.0	5.50	5.30	4.40	4.80	3.60	2.60	2.85	2.15	1.60	2.15	1.60	
30.0	4.60	5.00	4.30	4.70	3.40	2.55	2.65	2.05	1.55	2.05	1.55	1.10
32.0	3.90	4.20	4.20	4.40	3.30	2.45	2.45	1.95	1.50	1.90	1.45	1.05
34.0	3.30	3.60	3.80	3.90	3.10	2.40	2.30	1.85	1.45	1.75	1.35	1.00
36.0	2.80	3.00	3.20	3.30	3.00	2.35	2.15	1.75	1.40	1.65	1.30	0.95
38.0	2.30	2.50	2.70	2.80	2.90	2.30	2.00	1.65	1.35	1.50	1.20	0.95
40.0	1.90	2.10	2.20	2.40	2.75	2.25	1.90	1.60	1.35	1.40	1.15	0.90
42.0	1.50	1.60	1.70	2.00	2.30	2.20	1.80	1.55	1.30	1.30	1.10	0.85
44.0	1.10	1.30	1.40	1.70	2.00	2.15	1.70	1.45	1.25	1.25	1.05	0.85
46.0	0.80	0.90	1.00	1.40	1.60	1.80	1.60	1.40	1.25	1.15	1.00	0.80
48.0				1.10	1.30	1.40	1.40	1.35	1.20	1.10	0.95	0.80
50.0				0.80	1.00	1.10	1.10	1.30	1.20	1.00	0.90	0.80
52.0					0.80	0.80	0.90	1.20	1.20	0.95	0.85	0.80
54.0								0.90	1.10	0.80	0.80	0.80
56.0												

I	92	92	92	92
II	92	92	92	92
III	92	92	92	92
IV	92	92	92	92

Hubhöhen
Lifting heights
Hauteurs de levage
Alturas de elevación

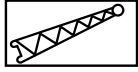
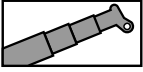

20.8t

DIN/ISO

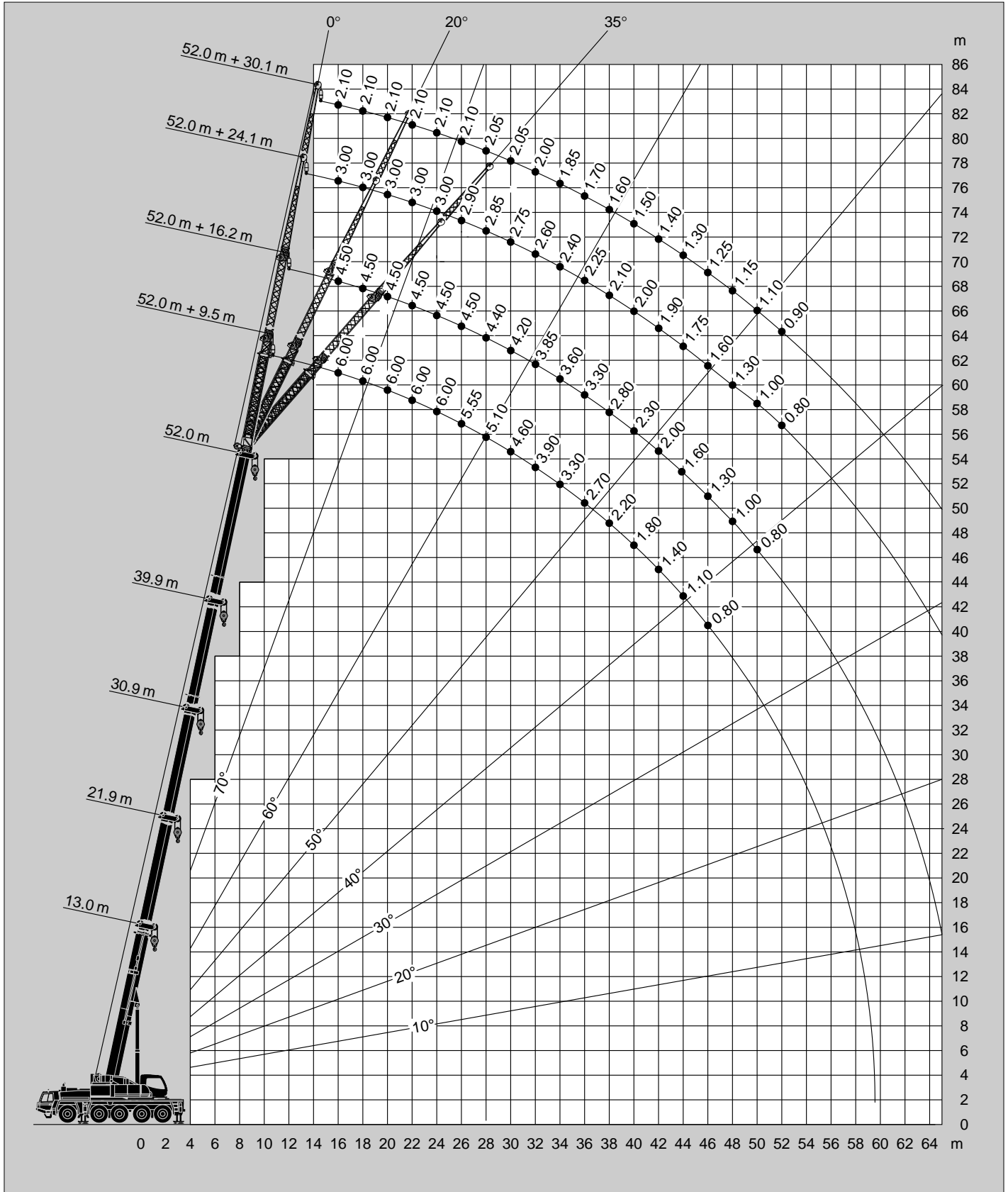

Tragfähigkeiten
Lifting capacities
Capacités de levage
Capacidades de elevación

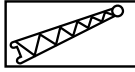
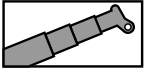

11t

DIN/ISO

m	52.0 m + 9.5 m			52.0 m + 16.2 m			52.0 m + 24.1 m			52.0 m + 30.1 m			
	0°	20°	35°	0°	20°	35°	0°	20°	35°	0°	20°	35°	
10.0	6.00												
11.0	6.00												
12.0	6.00												
14.0	6.00	6.00		4.50									
16.0	6.00	6.00	5.40	4.50			3.00			2.10			
18.0	6.00	6.00	5.20	4.50	4.00		3.00			2.10			
20.0	6.00	6.00	5.00	4.50	4.00		3.00	2.80		2.10			
22.0	6.00	5.90	4.90	4.50	3.80	2.55	3.00	2.60		2.10	2.00		
24.0	4.90	5.50	4.70	4.50	3.60	2.45	3.00	2.45		2.10	1.90		
26.0	4.00	4.50	4.60	4.50	3.40	2.35	2.90	2.35		2.10	1.75		
28.0	3.20	3.70	4.00	3.80	3.30	2.30	2.85	2.20	1.65	2.05	1.65		
30.0	2.60	2.90	3.20	3.10	3.10	2.20	2.75	2.10	1.60	2.05	1.55	1.10	
32.0	2.00	2.30	2.60	2.50	3.00	2.15	2.60	2.00	1.50	2.00	1.50	1.05	
34.0	1.50	1.80	2.00	2.00	2.60	2.10	2.30	1.90	1.50	1.85	1.40	1.00	
36.0	1.10	1.30	1.50	1.60	2.10	2.05	1.90	1.80	1.45	1.70	1.30	1.00	
38.0		0.90	1.10	1.20	1.70	2.00	1.50	1.75	1.40	1.60	1.25	0.95	
40.0				0.90	1.30	1.60	1.20	1.65	1.35	1.30	1.20	0.90	
42.0					0.90	1.20	0.80	1.40	1.35	1.00	1.15	0.90	
44.0						0.80		1.10	1.30		1.10	0.85	
46.0								0.80	1.10		1.00	0.85	
48.0									0.80			0.80	
50.0												0.80	
%	I	100			100			100			100		
	II	100			100			100			100		
	III	100			100			100			100		
	IV	100			100			100			100		

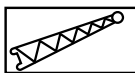
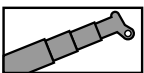

11t

DIN/ISO

m	48.9 m + 9.5 m			48.9 m + 16.2 m			48.9 m + 24.1 m			48.9 m + 30.1 m			
	0°	20°	35°	0°	20°	35°	0°	20°	35°	0°	20°	35°	
10.0	7.00												
11.0	7.00												
12.0	7.00	7.00											
14.0	7.00	7.00		5.10			3.20						
16.0	7.00	6.80	5.30	5.10	4.50		3.20			2.30			
18.0	7.00	6.60	5.10	5.10	4.50		3.20	2.90		2.30			
20.0	7.00	6.40	4.90	5.10	4.40	3.00	3.20	2.75		2.30			
22.0	6.10	6.20	4.80	5.10	4.20	2.90	3.20	2.55		2.30	2.00		
24.0	5.00	5.50	4.60	5.10	4.00	2.80	3.10	2.40		2.30	1.85		
26.0	4.00	4.50	4.50	4.60	3.80	2.70	2.95	2.25	1.65	2.20	1.75		
28.0	3.30	3.70	4.00	3.80	3.60	2.60	2.85	2.15	1.60	2.15	1.60		
30.0	2.60	3.00	3.20	3.20	3.40	2.55	2.65	2.05	1.55	2.05	1.55	1.10	
32.0	2.00	2.40	2.60	2.60	3.10	2.45	2.45	1.95	1.50	1.90	1.45	1.05	
34.0	1.50	1.80	2.00	2.10	2.60	2.40	2.30	1.85	1.45	1.75	1.35	1.00	
36.0	1.10	1.40	1.50	1.70	2.10	2.35	2.00	1.75	1.40	1.65	1.30	0.95	
38.0		1.00	1.10	1.30	1.70	2.00	1.60	1.65	1.35	1.50	1.20	0.95	
40.0				0.90	1.30	1.60	1.20	1.60	1.35	1.40	1.15	0.90	
42.0					1.00	1.20	0.90	1.40	1.30	1.10	1.10	0.85	
44.0						0.90		1.10	1.25	0.80	1.05	0.85	
46.0									1.20		1.00	0.80	
48.0									0.90			0.80	
%	I	92			92			92			92		
	II	92			92			92			92		
	III	92			92			92			92		
	IV	92			92			92			92		

Hubhöhen
Lifting heights
Hauteurs de levage
Alturas de elevación

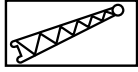
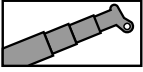

DIN/ISO

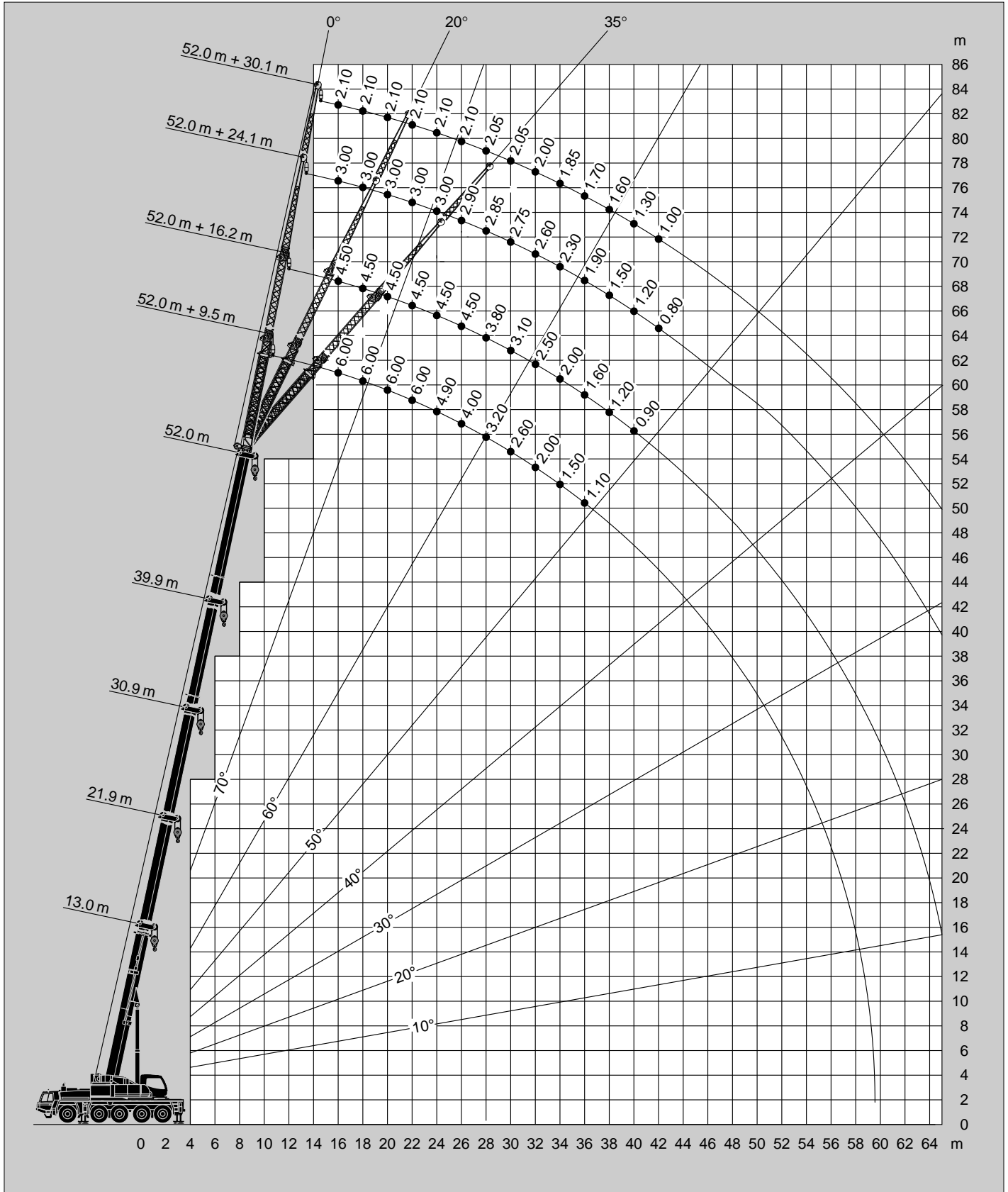

Tragfähigkeiten
Lifting capacities
Capacités de levage
Capacidades de elevación

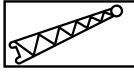
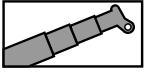

8.7t

DIN/ISO

m	52.0 m + 9.5 m			52.0 m + 16.2 m			52.0 m + 24.1 m			52.0 m + 30.1 m			
	0°	20°	35°	0°	20°	35°	0°	20°	35°	0°	20°	35°	
10.0	6.00												
11.0	6.00												
12.0	6.00												
14.0	6.00	6.00		4.50									
16.0	6.00	6.00	5.40	4.50			3.00			2.10			
18.0	6.00	6.00	5.20	4.50	4.00		3.00			2.10			
20.0	6.00	6.00	5.00	4.50	4.00		3.00	2.80		2.10			
22.0	5.40	5.90	4.90	4.50	3.80	2.55	3.00	2.60		2.10	2.00		
24.0	4.30	4.90	4.70	4.50	3.60	2.45	3.00	2.45		2.10	1.90		
26.0	3.40	3.90	4.30	4.00	3.40	2.35	2.90	2.35		2.10	1.75		
28.0	2.70	3.10	3.50	3.30	3.30	2.30	2.85	2.20	1.65	2.05	1.65		
30.0	2.10	2.50	2.70	2.60	3.10	2.20	2.75	2.10	1.60	2.05	1.55	1.10	
32.0	1.60	1.90	2.10	2.10	2.70	2.15	2.40	2.00	1.50	2.00	1.50	1.05	
34.0	1.10	1.40	1.60	1.60	2.10	2.10	1.90	1.90	1.50	1.85	1.40	1.00	
36.0		1.00	1.10	1.20	1.70	2.00	1.50	1.80	1.45	1.60	1.30	1.00	
38.0				0.80	1.30	1.60	1.10	1.75	1.40	1.30	1.25	0.95	
40.0					0.90	1.20	0.80	1.40	1.35	0.90	1.20	0.90	
42.0						0.80		1.10	1.35		1.15	0.90	
44.0								0.80	1.20		1.00	0.85	
46.0									0.80			0.85	
48.0												0.80	
%	I	100			100			100			100		
	II	100			100			100			100		
	III	100			100			100			100		
	IV	100			100			100			100		

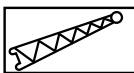
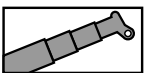

8.7t

DIN/ISO

m	48.9 m + 9.5 m			48.9 m + 16.2 m			48.9 m + 24.1 m			48.9 m + 30.1 m			
	0°	20°	35°	0°	20°	35°	0°	20°	35°	0°	20°	35°	
10.0	7.00												
11.0	7.00												
12.0	7.00	7.00											
14.0	7.00	7.00		5.10			3.20						
16.0	7.00	6.80	5.30	5.10	4.50		3.20			2.30			
18.0	7.00	6.60	5.10	5.10	4.50		3.20	2.90		2.30			
20.0	6.80	6.40	4.90	5.10	4.40	3.00	3.20	2.75		2.30			
22.0	5.40	6.00	4.80	5.10	4.20	2.90	3.20	2.55		2.30	2.00		
24.0	4.40	4.90	4.60	5.00	4.00	2.80	3.10	2.40		2.30	1.85		
26.0	3.50	3.90	4.30	4.10	3.80	2.70	2.95	2.25	1.65	2.20	1.75		
28.0	2.70	3.20	3.50	3.30	3.60	2.60	2.85	2.15	1.60	2.15	1.60		
30.0	2.10	2.50	2.80	2.70	3.30	2.55	2.65	2.05	1.55	2.05	1.55	1.10	
32.0	1.60	1.90	2.10	2.20	2.70	2.45	2.45	1.95	1.50	1.90	1.45	1.05	
34.0	1.10	1.40	1.60	1.70	2.20	2.40	2.00	1.85	1.45	1.75	1.35	1.00	
36.0		1.00	1.20	1.30	1.70	2.10	1.60	1.75	1.40	1.65	1.30	0.95	
38.0				0.90	1.30	1.60	1.20	1.65	1.35	1.40	1.20	0.95	
40.0					1.00	1.20	0.90	1.50	1.35	1.00	1.15	0.90	
42.0						0.90		1.10	1.30		1.10	0.85	
44.0								0.80	1.20		1.05	0.85	
46.0									0.90		0.80	0.80	
48.0												0.80	
%	I	92			92			92			92		
	II	92			92			92			92		
	III	92			92			92			92		
	IV	92			92			92			92		

Hubhöhen
Lifting heights
Hauteurs de levage
Alturas de elevación

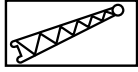
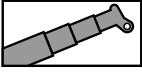

8.7t

DIN/ISO

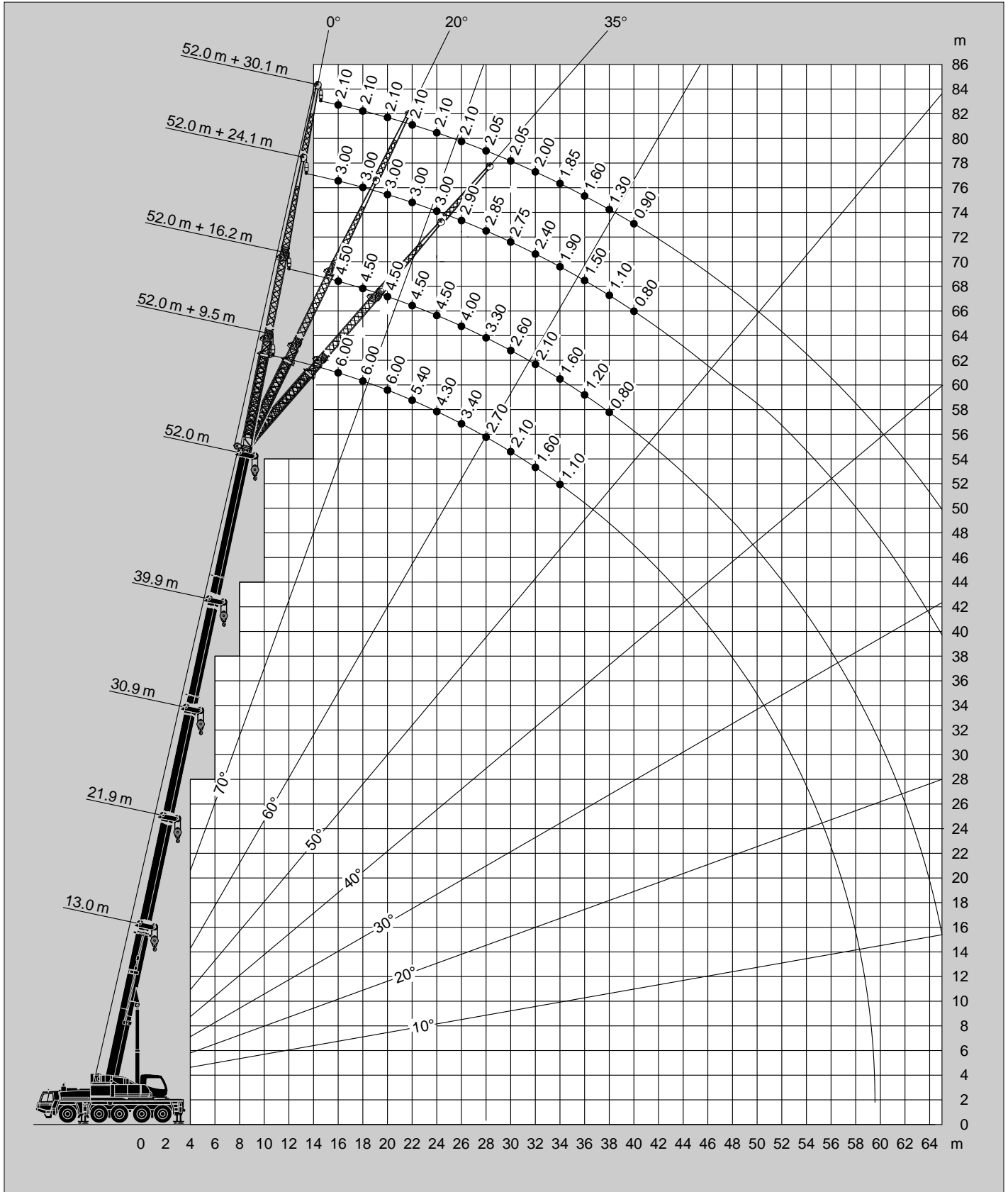

Anmerkungen zu den Traglasttabellen

Die Tragfähigkeiten im Festigkeitsbereich basieren auf DIN 15018 Blatt 2 und Blatt 3 und F.E.M.

Die Tragfähigkeiten im Standsicherheitsbereich entsprechen DIN 15019 Teil 2 / ISO 4305.

Die zulässige Windgeschwindigkeit beträgt maximal 10 m/sec.

Die Tragfähigkeiten sind in metrischen Tonnen angegeben.

Das Gewicht des Lasthakens bzw. der Hakenflasche und weiterer Anschlagmittel ist von der Tragfähigkeit abzuziehen.

Die Tragfähigkeiten für den Teleskopausleger gelten nur bei demonstrierter Spitze.

Die Ausladung ist der horizontale Abstand von Mitte Drehkranz bis Mitte freihängender, nicht schwingender Last.

Tragfähigkeitsänderungen vorbehalten.

Obige Angaben dienen nur zur Information. Die Bedienungsanleitungen müssen zu Rate gezogen werden, bevor die Maschine in Betrieb genommen wird. Alle hier gemachten Angaben beziehen sich auf die Standard-Ausführung. Jegliche Ausrüstungsveränderungen können die angegebenen Werte beeinflussen.

Remarks relating to the rating charts

The lifting capacities in the structural area are based on DIN 15018 parts 2 and 3 and F.E.M.

The lifting capacities in the stability area are based on DIN 15019 part 2 / ISO 4305.

The maximum permissible wind speed for crane operation is 10 m/sec.

The lifting capacities shown are in metric tons.

The weight of load handling devices such as hook blocks, slings, etc., must be considered as part of the load and must be deducted from the lifting capacities.

The lifting capacities for the telescopic boom apply to a crane with no boom extensions being stowed or mounted on the crane.

The working radius is the horizontal distance from the centre of rotation to the centre of the freely suspended non-oscillating load.

The lifting capacities are subject to change without prior notice.

The above remarks are for basic information only and the operator's manual must be consulted before operating this crane. All data and performances refer to the standard crane. The addition of optional and other equipment may affect the performance of the crane.

Remarques relatives aux tableaux des charges

Les forces de levage sont conformes aux normes DIN 15018, p. 2 et 3, et F.E.M.

Les forces de levage dans la partie de stabilité au renversement sont conformes aux normes DIN 15019, chap. 2 / ISO 4305.

La grue peut travailler aux vitesses de vent allant jusqu'à 10 m/s.

Les forces de levage sont données en tonnes métriques.

Le poids du crochet-moufle et de tous les accessoires d'élingage font partie de la charge et sont à déduire des charges indiquées.

Les forces de levage indiquées pour la flèche télescopique s'entendent fléchette déposée.

Comme portée, on entend la distance horizontale du centre de la couronne de rotation au centre de la charge librement suspendue et non oscillante.

Sauf modification de forces de levage.

Les données ci-dessus servent à titre d'information. Avant la mise en marche de la grue il est conseillé d'étudier les instructions de service. Toutes les données indiquées ci-dessus se réfèrent à la machine de base. Tout changement de l'équipement de la grue peut influencer ces valeurs.

Notas relativas a los graficos de carga

En cuanto a los datos referentes a resistencia, las capacidades de carga están basados sobre las normas DIN 15018, pág. 2 y 3, y F.E.M.

En cuanto a los datos referentes a estabilidad anti-vuelco, las capacidades de carga están basados sobre las normas DIN 15019, Cap. 2 / ISO 4305.

La velocidad anemométrica max. admisible es de 10 m/seg.

Las capacidades de carga indicadas en las tablas corresponden a toneladas métricas.

Hay que deducir los pesos del gancho, eslingas y de otros dispositivos para fijación de cargas de los valores indicados en las tablas.

Las capacidades de carga referentes a la pluma telescópica valen solamente si el plumín está desmontada.

Como alcance se entiende la distancia horizontal desde el centro de la corona de giro hasta el centro de la carga suspendida libremente y no oscilante.

Salvo modificación de capacidades de carga, sin previo aviso.

Los datos arriba indicados sirven solamente para su información. Hay que leer las instrucciones para el uso antes de la puesta en servicio de la máquina. Todos los datos mencionados en las presentes tablas rigen para los modelos standard. Cualquier modificación del equipo montado puede dar lugar a modificaciones de aquellos valores.

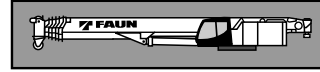

Rahmen Verwindungs- und biegesteife Schweißkonstruktion aus hochfestem Feinkornstahl. Zentralschmieranlage.

Abstützung 4-Punkt-Abstützung, hydraulisch, Bedienungsmöglichkeiten an beiden Seiten des Fahrgestelles und in der Oberwagenkabine.
Abstützbasis 7,5 m (und 5,0 m) x 7,74 m.

Motor Mercedes-Benz 8-Zylinder-Dieselmotor OM 502 LA (Euromot 2/EPA 2), wassergekühlt, Leistung 380 kW (517 PS) bei 1800 min⁻¹.
Drehmoment 2400 Nm (245 kpm) bei 1200 min⁻¹.
Motorleistung nach 80/1269/EWG.

Getriebe ZF-AS-Tronic 16 AS 2602 mechanisches Schaltgetriebe mit elektronisch-pneumatisch geregelter Trockenkupplung und vollautomatischer Schaltung mit 16 Vorwärts- und 2 Rückwärtsgängen.

Verteilergetriebe 2-stufiges Verteilergetriebe VG 3750.

Antrieb 10 x 6

Achsen

1. Achse: gelenkt, nicht angetrieben.
 2. Achse: gelenkt, angetrieben.
 3. Achse: nicht gelenkt, nicht angetrieben, liftbar.
 4. Achse: gelenkt, angetrieben, Differentialsperre längs.
 5. Achse: gelenkt, angetrieben.
- Differentialsperren in allen Antriebsachsen.

Achsaufhängung Hydropneumatische Federung mit Niveauregulierung.

Bremsen Druckluft-Zweikreis-Bremsanlage. Feststellbremse als Federspeicherbremse an der 2., 4. und 5. Achse wirkend. Intarder und Dauerbremse als Konstantdrosselanlage mit Auspuffklappenbremse.

Räder 10-fach 16.00 R 25

Lenkung ZF-Servocom-Zweikreishydraulenlenkung. Mechanische Lenkung der 1. und 2. Achse und Mitlenken der 4. Achse bis zu einer Geschwindigkeit von 25 km/h und der 5. Achse bis zu einer Fahrgeschwindigkeit von 50 km/h, mit Notlenkpumpe.

Untergartenkabine Zwei-Mann-Frontfahrerhaus in Stahl-Kunststoff-Verbund-Konstruktion, Sicherheitsverglasung, luftgefederte Sitze und motorabhängige Warmwasserheizung, Kontroll- und Bedienungselemente für den Fahrbetrieb, Tempomat-Funktion.

Elektrische Anlage 24 Volt-Gleichstrom, 2 Batterien, Verdrahtung mit CAN-Bus-Komponenten, integrierte Eigendiagnose Faun-CSS-System, Abstützbeleuchtung. Die elektrische Anlage entspricht der EG-Norm.

Zusatzrüstung (gegen Mehrpreis)
Anhängekupplung, Zusatzheizung, Motorvorwärmung, Klimaanlage, 10 x 8 Antrieb, ABS, 14.00 R 25/20.5 R 25 Bereifung, Reserverad, Sonderlackierung und Beschriftung, Stützkraftanzeige.

Weitere Zusatzrüstung auf Anfrage.

Rahmen Verwindungssteife Schweißkonstruktion mit einer außenverzahnten, einreihigen Kugeldrehverbindung, um 360° unbegrenzt drehbar. Zentralschmieranlage.

Motor Mercedes-Benz 4-Zylinder-Dieselmotor OM 904 LA (Euromot 2/EPA 2), wassergekühlt. Drehzahl ist über Fußpedal stufenlos regelbar, Leistung 130 kW (177 PS) bei 2200 min⁻¹. Drehmoment 660 Nm (67 kpm) bei 1200 min⁻¹. Motorleistung nach DIN 6270B/DIN 6271.

Hydraulik System Diesel-hydraulisch mit 3-Kreis-Hydraulik, 1 Axialkolbendoppelpumpe und 1 Axialkolbenpumpe.

Steuerung Zwei 4-fach Kreuzsteuerhebel mit elektrischer Vorsteuerung.

Teleskopausleger Fünfteiliger Teleskopausleger aus hochfestem Feinkornstahl, bestehend aus einem Grundausleger und 4 Teleskopteilen, 1 Teleskopzylinder, hydraulisch unter Teillast teleskopierbar. 12,8 m - 52,0 m lang.

Wippwerk Ein Differentialzylinder mit angebautelem Senkbremssperrventil.

Hubwerk Axialkolben-Motor, Hubwerkstrommel mit eingebautem Planetengetriebe und federbelasteter Hydro-Lamellenbremse mit integriertem Freilauf beim Heben. Hubseil mit 'Super-Stop' Einrichtung.

Drehwerk Axialkolben-Motor, dreistufiges Planetengetriebe mit automatischer Feststellbremse, offener Kreis mit Drehwerk-Freischaltung.
Drehgeschwindigkeit stufenlos von 0 - 1,7 min⁻¹.

Gegengewicht Gesamtgewicht 8,7/11,0 t teilbar. Die Bedienung erfolgt aus der Oberwagenkabine.

Oberwagenkabine Großräumige Krankabine in Stahl-Kunststoffausführung mit Sicherheitsverglasung mit getönten Scheiben, kippbarem Arbeitsplatz mit verstellbarem, gefedertem, gedämpftem Fahrersitz, motorabhängige und motorunabhängige Warmwasserheizung (mit Motor-Vorwärmung), Kontroll- und Bedienungselemente sowie graphische LCD-Anzeige für Kranbetrieb.

Elektrische Anlage 24 Volt-Gleichstrom, 2 Batterien.

Sicherheitseinrichtungen Lastmomentbegrenzung (LMB), Windmesser, Arbeitsbereichsanzeige, Hubendschalter, Windendenschalter, Seilwindendrehmelder, Sicherheitsventile gegen Rohr- und Schlauchbrüche. Sperrventile an Hydraulik-Zylindern.

Zusatzrüstung (gegen Mehrpreis)
Auslegerverlängerungen von 9,5 m / 16,2 m bis 30,1 m, Schwerlastspitze 3,5 m, Zusatzgegengewicht für max. 35 t, Gegengewichtsvarianten 0 t / 4,5 t / 20,8 t / 28,8 t, Unterflaschen von 10 t bis 125 t, Drehbereichsbegrenzung, Klimaanlage, 2. Hubwerk (wie Hauptwinde), Sonderlackierung und Beschriftung.

Weitere Zusatzrüstung auf Anfrage.

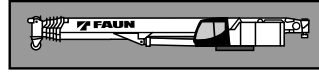

Frame Torsion resistant, welded construction made from high strength, fine-grained steel. Central lubricating system.

Outriggers 4 point, double telescopic hydraulic outriggers with controls on both sides of carrier and in superstructure cab. Outrigger base 7.5 m (5.0 m mid extension) x 7.74 m.

Carrier engine Mercedes-Benz 8 cylinder model OM 502 LA (Euromot 2/EPA 2), water-cooled diesel engine. Rated at 380 kW (517 HP) at 1800 min⁻¹. Torque 2400 Nm (245 kpm) at 1200 min⁻¹. Engine rating according to 80/1269/EWG.

Transmission ZF-AS-Tronic 16 AS 2602 mechanical transmission with electro-pneumatically actuated dry-type clutch and automatic gear shifting with 16 forward gears and 2 reverse gears.

Transfer Case Two stage Steyr model VG 3750.

Drive 10 x 6

Axles

1st axle: steered, not driven.
 2nd axle: steered, driven.
 3rd axle: not steered, not driven, lift axle.
 4th axle: steered, driven, with longitudinal differential lock.
 5th axle: steered, driven.
 All driven axles with transverse differential locks.

Suspension Hydro-pneumatic with levelling adjustment.

Brake system Service brakes: dual circuit compressed air system. Parking brake: spring loaded type acting on 2nd, 4th and 5th axles. Auxiliary brakes: intarder, engine exhaust brake and constant throttle engine brake system.

Tyres (10) 16.00 R 25

Steering system ZF-Servocom, dual circuit hydraulic steering, mechanical hydraulically-assisted steering of front two axles and automatic steering of the 4th axle up to a travel speed of 25 km/h and of the 5th axle up to 50 km/h, with emergency steering pump.

Carrier cab Two man full width cab of composite (steel sheet metal and fibre-glass) structure, with safety glass, air-cushioned adjustable seats, engine dependent hot-water heater. Complete controls and instrumentation for road travel. Speed control.

Electrical system 24 volt DC system, 2 batteries, CAN-Bus system with Faun CSS integrated self-diagnosis system, outrigger lighting. Electrical system conforms with EEC regulations.

Optional Equipment (at extra charge)
 Towing attachment, additional heater, engine pre-heat, air conditioning, 10 x 8 drive, ABS, 14.00 R 25/20.5 R 25 tyres, spare wheel and tyre, special painting and lettering, outrigger load display.

Further optional equipment available upon request.

Frame Torsion-resistant, all-welded structure of high strength steel. Connected to carrier by single-row ball-bearing slewing ring with external gearing for 360° continuous rotation. Central lubricating system.

Superstructure engine Mercedes-Benz 4 cylinder model OM 904 LA (Euromot 2/EPA 2), water cooled, diesel engine. Rated at 130 kW (177 HP) at 2200 min⁻¹. Torque 660 Nm (67 kpm) at 1200 min⁻¹. Engine rating according to DIN 6270B/DIN 6271.

Hydraulic system Three circuit diesel hydraulic system with 1 double axial piston pump and 1 axial piston pump.

Controls Electrical, 2 joy-stick levers for simultaneous operation of crane motions.

Telescopic boom 5 sections, made of high tensile, fine-grained steel, consisting of 1 base section and 4 telescoping sections extended by means of a single telescopic cylinder. All telescope sections extendable under partial load. 12.8 m to 52.0 m long.

Derricking system 1 double acting hydraulic cylinder with integral brake and holding valve.

Main winch Axial piston motor, winch drum with integrated planetary reduction and with hydraulically controlled spring-loaded, multiple disc brake and with integrated free rotation (no sagging of load when hoisting). Hoist cable with 'Super-Stop' easy reeving system.

Slewing system Axial piston motor with three-stage planetary reduction with a foot actuated or automatic service and a parking brake, open circuit with free slewing function. Speed infinitely variable 0 - 1.7 min⁻¹.

Counterweight Total 8.7/11.0 t divisible, assembled and disassembled by hydraulic cylinders controlled from superstructure cab.

Superstructure cab Spacious all-steel panoramic cab with safety (tinted) glass windows, tiltable cockpit with hydraulically cushioned adjustable seat, one engine dependent hot water heater and one engine independent hot-water heater (with engine pre-heat). Complete controls and instrumentation plus LCD graphic display for crane operation.

Electrical system 24 volt DC system, 2 batteries.

Safety devices Load moment device (LMD), anemometer, working area display, hoist limit switch, lower limit switch and drum turn indicator, safety valves against pipe and hose rupture, holding valves on hydraulic cylinders.

Optional Equipment (at extra charge)
 Boom extensions 9.5 m/16.2 m to 30.1 m, heavy duty jib 3.5 m, additional counterweight for max. 35 t, counterweight variations 0 t/4.5 t/20.8 t/28.8 t, selection of hook blocks 10 t - 125 t, slewing area limitation, air conditioning, auxiliary winch (same as main winch), special painting and lettering.

Further optional equipment available upon request.

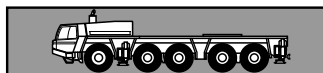

Châssis Construction mécano-soudée, en acier fin, résistante aux flexions et aux torsions. Système de graissage centralisé.

Calage Calage à 4 points, complètement hydraulique. Commande des stabilisateurs des deux côtés du châssis et de la cabine du grutier. Calage 7,5 m (aussi 5,0 m) x 7,74 m.

Moteur Mercedes Benz diesel de 8 cylindres, modèle OM 502 LA (Euromot 2/EPA 2), refroidi par eau, de 380 kW (517 CV) à 1800 min⁻¹.
Couple: 2400 Nm (245 kpm) à 1200 min⁻¹.
Puissance selon 80/1269/EWG.

Boîte de vitesse Boîte mécanique ZF-AS-Tronic, modèle 16 AS 2602 avec embrayage électro-pneumatique et boîte automatique, 16 vitesses AV et 2 vitesses AR.

Boîte de transfert Boîte de transfert VG 3750.

Entraînement 10 x 6

Essieux

1^{er} essieu: directeur, non entraîné.
2^{ème} essieu: directeur, entraîné.
3^{ème} essieu: non directeur, non entraîné, peut être levé.
4^{ème} essieu: directeur, entraîné, blocage de différentiel longitudinal.
5^{ème} essieu: directeur, entraîné.
Blocage de différentiel pour tous essieu entraînés.

Suspension Hydro-pneumatique, avec réglage de niveau.

Freins Système à air comprimé, à double circuit. Frein de stationnement: avec accumulateurs à ressort agissant sur le 2^{ème}, 4^{ème} et 5^{ème} essieu. Intarder, frein continu: Frein sur échappement avec étrangleur.

Pneus 10 x 16.00 R 25

Direction Servocom à double circuit, marque ZF. Direction mécanique du 1^{er} et 2^{ème} essieu, à assistance hydraulique, avec pompe de direction auxiliaire direction du 4^{ème} essieu jusqu'à une vitesse de 25 km/h et du 5^{ème} essieu jusqu'à une vitesse de 50 km/h, avec pompe de direction auxiliaire.

Cabine Cabine bi-place, construction en matière composite fibre de verre et acier. Vitrage en verre de sécurité, sièges à suspension pneumatique. Chauffage à eau chaude relié au moteur. Organes de contrôle et de commande pour la conduite. Régulateur de vitesse.

Système électrique 24 V courant continu, 2 batteries, connexion circuit électrique avec CAN-Bus. Équipement avec prise diagnostic et avec interprétation de code erreur de système FAUN CSS, illumination des calages. Conforme aux normes CE.

Équipement supplémentaire (avec supplément de prix) Attache-remorque, chauffage auxiliaire, préchauffage du moteur, climatisation, entraînement 10 x 8, ABS, pneus 14.00 R 25 / 20.5 R 25, roue de secours, peinture spéciale et inscription. Indicateur de pression sur les calages.

Autres équipements supplémentaires sur demande.

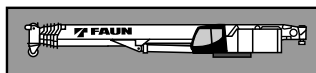

Plate forme Construction mécano-soudée résistante à la torsion. Couronne d'orientation à billes à une rangée, à denture extérieure, permettant une rotation illimitée sur 360°. Système de graissage centralisé.

Moteur Mercedes Benz diesel 4 cylindres, modèle OM 904 LA (Euromot 2/EPA 2), refroidi par eau, Réglage du nombre de tours par pédale, de 130 kW (177 CV) à 2200 min⁻¹.
Couple: 660 Nm (67 kpm) à 1200 min⁻¹.
Puissance selon DIN 6270B/DIN 6271.

Système hydraulique Diesel-hydraulique à 3 circuits, 1 double pompe à pistons axiaux et 1 pompe à pistons axiaux.

Commande 2 manipulateurs à commande en croix (4 sens), assistés électriquement.

Flèche télescopique 1 flèche de base et 4 éléments télescopiques en acier fin, 1 vérin télescopique, hydrauliquement télescopable avec charge partielle. Longueur 12,8 m à 52,0 m.

Mécanisme de relevage 1 vérin différentiel muni de clapet de freinage de descente.

Mécanisme de levage Moteur hydraulique, tambour de levage avec boîte planétaire incorporée, frein d'arrêt à disques multiples à ressort, libéré lors du levage. Câble de levage avec dispositif 'Super-Stop'.

Orientation Moteur hydraulique avec entraînement planétaire à 3 gammes avec frein de stationnement automatique. Vitesse de rotation 0 à 1,7 min⁻¹ en continu.

Contrepoids Poids total 8,7 / 11,0 t divisible, commandé depuis la cabine du grutier.

Cabine du grutier Cabine de grue spacieuse, construction en matière combinée acier/synthétique, avec vitrage de sécurité en verre teinté, siège réglable et amorti hydrauliquement, inclinable avec instruments de commande, chauffage à eau chaude dépendant et indépendant du moteur (avec préchauffage du moteur), éléments de commande et de contrôle avec affichage digital pour travaux.

Système électrique 24 V courant continu, 2 batteries.

Dispositifs de sécurité Limiteur de charge (CEC), anémomètre, indicateur de portée, interrupteur de fin de course de levage et de treuil, indicateur du nombre de tours, soupapes de sécurité contre ruptures des conduites et flexibles, clapets sur verins hydrauliques.

Équipement supplémentaire (avec supplément de prix) Fléchette de 9,5 m / 16,2 m à 30,1 m. Fléchette pour levage lourd 3,5 m, contre-poids additionnel pour max. 35 t, combinaison différentes de contrepoids 0 t / 4,5 t / 20,8 t / 28,8 t, moufles de 10 t à 125 t, limitation de rotation, climatisation, 2^{ème} treuil de levage (identique au treuil principale), peinture spéciale et inscription.

Autres équipements supplémentaires sur demande.



Chasis portante Construcción de acero de alta resistencia soldado, resistente a la torsión y a la flexión. Sistema de engrase central.

Estabilizadores Estabilizadores hidráulicos de 4 puntos. Posibilidad de manejo desde ambos lados del chasis portante y desde la cabina de la grúa. Extensión de los estabilizadores: 7,5 m (y 5,0 m) x 7,74 m.

Motor Mercedes Benz modelo OM 502 LA (Euromot 2/EPA 2), 8 cilindros, diesel, refrigerado por agua. Nominal 380 kW (517 HP) a 1800 min⁻¹. Par 2400 Nm (245 kpm) a 1200 min⁻¹. Potencia del motor según 80/1269/EWG.

Transmisión Transmisión mecánica ZF tipo AS-Tronic modelo 16 AS 2602, con 16 marchas adelante y dos marchas atrás, controladas electro - neumáticamente con embrague en seco.

Transmisión Caja de distribución de dos escalones tipo VG 3750.

Tracción 10 x 6

Ejes

- 1º eje: de dirección, no accionado.
 - 2º eje: de dirección, accionado.
 - 3º eje: no articulado, no direccionable, elevable.
 - 4º eje: de dirección, accionado, con bloqueo diferencial longitudinal.
 - 5º eje: de dirección, accionado.
- Bloqueos diferenciales en todos los ejes motrices.

Suspensión Suspensión hidroneumática con regulación de nivel.

Sistemas de frenos Accionamiento neumático de doble circuito. Freno de estacionamiento del tipo muelles cargados, liberados por aire, sobre los ejes 2º, 4º y 5º. Intarder y freno continuo: sistema estrangulador constante y freno tipo estrangulación sobre el escape del motor diesel.

Neumáticos 10 x 16.00 R 25

Dirección Hidráulica ZF Servocom de doble circuito. Dirección mecánica del 1º y 2º eje y direccionable del 4º eje hasta una velocidad de 25 km/h y del 5º eje hasta una velocidad de conducción de 50 km/h, con bomba auxiliar de dirección.

Cabina Cabina para dos personas, en construcción de acero y fibra de vidrio. Cristales de seguridad, asiento con suspensión neumática, calefacción por agua caliente del motor. Elementos de control e instrumentos para circulación por carretera. Regulador de velocidad.

Sistema eléctrico Sistema de 24 V c.c. con 2 baterías, conexiones eléctricas integradas en el sistema CAN-Bus, sistema integrado de diagnóstico Faun-CSS. Faros en gatos. El sistema eléctrico cumple la normativa CEE.

Equipo adicional (con suplemento de precio) Embrague de remolque, calefacción adicional, precalefacción del motor, climatización, tracción 10 x 8, ABS, neumáticos 14.00 R 25/20.5 R 25, rueda de repuesto, pintura especial e inscripción. Control carga (gatos de apoyo).

Otros equipamientos sobre demanda.

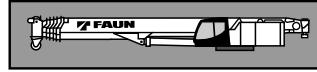

Superestructura Construida en aceros soldados, resistente a la torsión. Corona de giro con rodamiento de una fila de bolas con dientes externos para giro continuo a 360°. Sistema de engrase central.

Motor Mercedes Benz modelo OM 904 LA (Euromot 2/EPA 2), 4 cilindros, diesel, refrigerado por agua. Las revoluciones aumentan de forma gradual accionado el acelerador. Nominal 130 kW (177 HP) a 2200 min⁻¹. Par 660 Nm (67 kpm) a 1200 min⁻¹. Potencia del motor según DIN 6270B/DIN 6271.

Sistema hidráulico Sistema hidráulico de 3 circuitos, 1 bomba doble de pistones axiales y una bomba de pistones axiales.

Mandos 2 palancas de control de tipo joy-stick para movimientos simultáneos de la grúa (4 direcciones), asistidos eléctricamente.

Pluma telescópica 5 secciones, un tramo base y 4 telescópicas de acero de alta resistencia soldado, 1 cilindro hidráulico, los tramos se pueden telescopar hidráulicamente bajo carga. Longitud de 12,8 m a 52,0 m.

Elevación de pluma Mediante un cilindro hidráulico de doble efecto con válvula de retención integrada.

Cabrestante principal Motor hidráulico de pistones axiales. Tambor del cabrestante con reducción planetaria y frenos de disco múltiples accionado, con sistema libre de elevación. Cable de elevación con sistema de enhebrado fácil y 'Super-Stop'.

Sistema de giro Motor hidráulico de pistones axiales con reducción planetaria de tres etapas. Con freno de giro automático. Circuito abierto con mecanismo de giro libre con posibilidad de desconexión. Velocidad de giro gradual de 0 a 1,7 min⁻¹.

Contrapeso Peso total 8,7/11,0 t divisible, accionado desde la cabina de la grúa.

Cabina de la grúa Cabina espaciosa y confortable, en construcción de acero y fibra de vidrio, con cristales coloreados de seguridad. Asiento del operador regulable amortiguado hidráulicamente, inclinable junto con los instrumentos y mandos, calefacción por agua caliente dependiente e independiente del motor (con precalefacción del motor). Controles, instrumentos y mandos de conducción como display digital LCD para la operación de la grúa.









Sistema eléctrico Sistema de 24 V c.c. con 2 baterías.



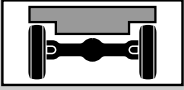

Medidas de seguridad Limitación del momento de carga (LMC), anemómetro, indicador del área de trabajo, interruptor de final de elevación, interruptor de 3 últimas vueltas en cabrestante, indicador de bajada o subida del cable del cabrestante, válvulas de seguridad para rotura de tubos y latiguillos. Válvulas de retención en los cilindros hidráulicos.

Equipo adicional (con suplemento de precio) Plumín de 9,5 m/16,2 m a 30,1 m. Plumín de carga pesada de 3,5 m. Contrapeso adicional para max. 35 t. Variantes de contrapeso 0 t/4,5 t/20,8 t/28,8 t, Gancho de 10 a 125 to. Limitador de giro, climatización, 2º cabrestante (similar a cabrestante principal), pintura especial y rotulación.

Otros equipamientos sobre demanda.

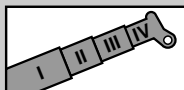
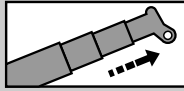
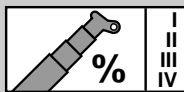
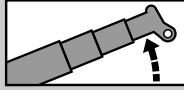
Symbolerklärung Symbols Glossaire des symboles Glosario de simbolos

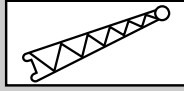
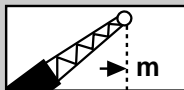
DIN / ISO	Siehe Seite 26 As on Page 26 Voyez la page 26 Véase la pagina 26
	Abstützung Outriggers Calage Estabilizadores
	Getriebe / Gang Transmission / Gear Boîte de vitesse / Rapport Transmisión / Marchas
	Achslast Axle load Charge à l'essieu Carga por eje
 16.00 R 25	Räder / Größe Tyres / Size Pneus / Largeur Neumáticos / Tamaño de ruedas
	Gelände Off road Tout-terrain Todo terreno
	Straße On road En route En carretera
V+	Geschwindigkeiten Speeds Vitesses Velocidades
	Steigfähigkeit Gradeability Abtitude en pente Superacion de pendientes
	Drehwerk Slewing system Orientation Sistema de giro
35t	Gegengewicht Counterweight Contrepoids Contrapeso

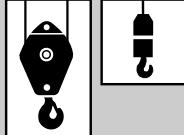
	Teleskopausleger Telescopic boom Flèche télescopique Pluma telescópica
	Teleskopieren Boom telescoping Télescopage de flèche Telescopaje de pluma
	Teleskopieren in % Boom telescoping in % Télescopage de flèche en % Telescopaje de pluma en %
	Wippwerk Derricking system Mécanisme de relevage Elevación de pluma
	Ausladung Radius Portée Radio
	Auslegerverlängerung Boom extension Fléchette Plumín
	Ausladung Radius Portée Radio
	Hubwerk Main winch Mécanisme de levage Cabrestante principal
	2. Hubwerk Auxiliary winch 2 ^{ème} treuil de levage 2 ^º cabrestante
	Unterflasche / Hakengeschrir Hook block / Swivel hook Moufle / Elingues Gancho / Gancho de bola