

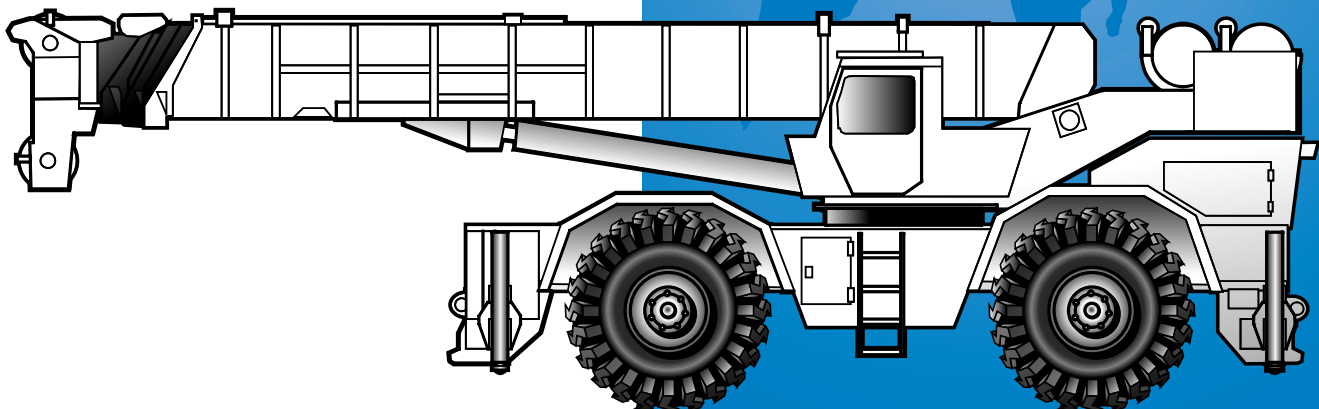

**GROVE**<sup>®</sup>  
**CRANE**

# RT9100



**Rough Terrain Hydraulic Crane**

# Dimensions

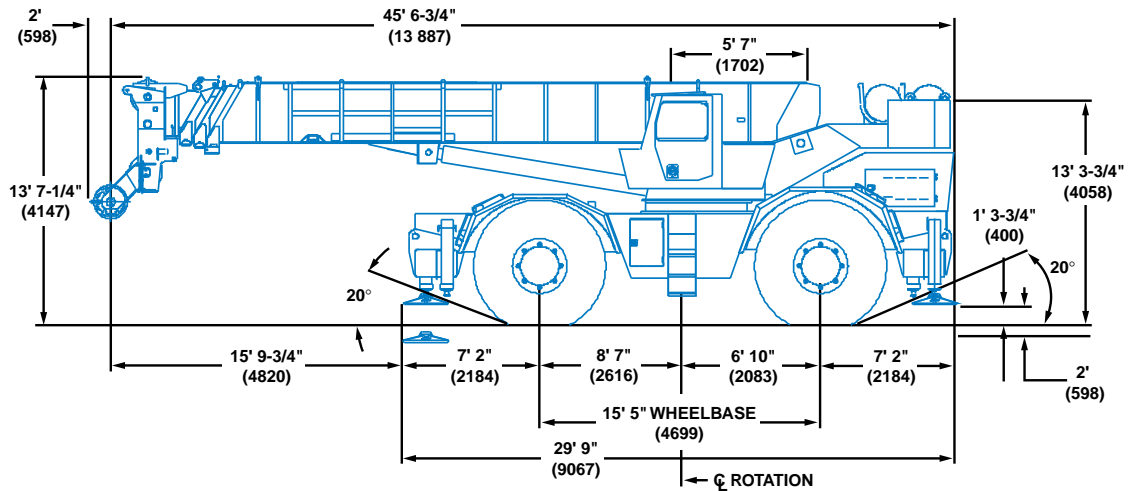
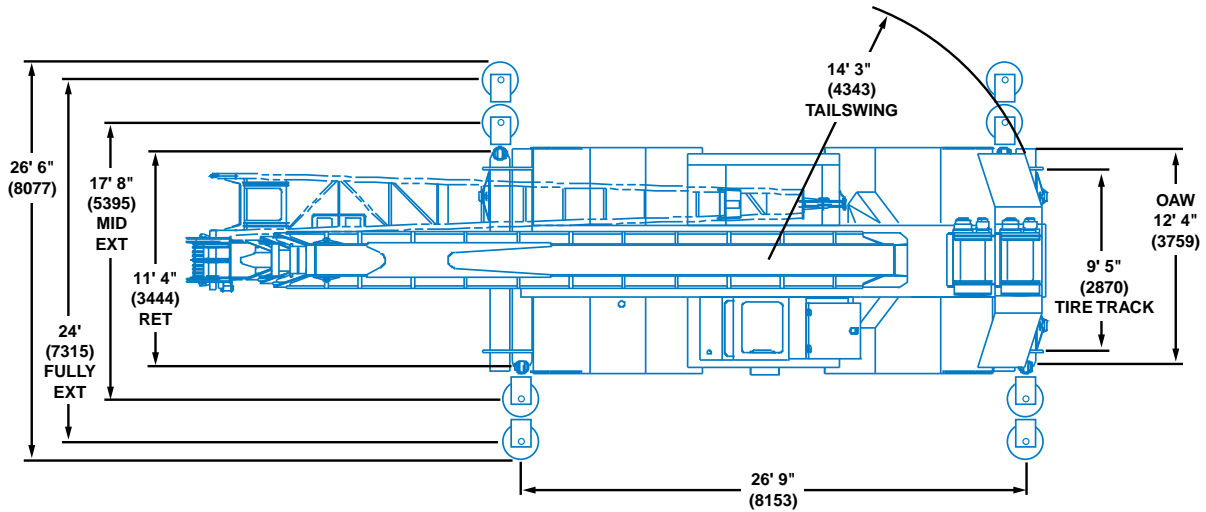

Note: ( ) Reference dimensions in mm

- Turning Radius** . . . . . 25' (7620 mm)
- Front Axle Load** . . . . . 64,649 lbs. (29 325 kg)
- Rear Axle Load** . . . . . 69,809 lbs. (31 665 kg)
- Gross Vehicle Weight** . . . . . 134,458 lbs. (60 990 kg)

# Working range



36 - 114 ft.  
(11.0 - 34.7 m)

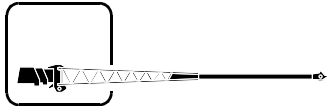

33 - 58 ft.  
(10.0 - 17.7 m)



17,800 lbs.  
(8074 kg)

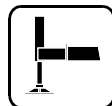

100%



360°

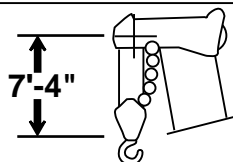
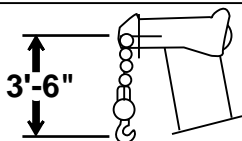
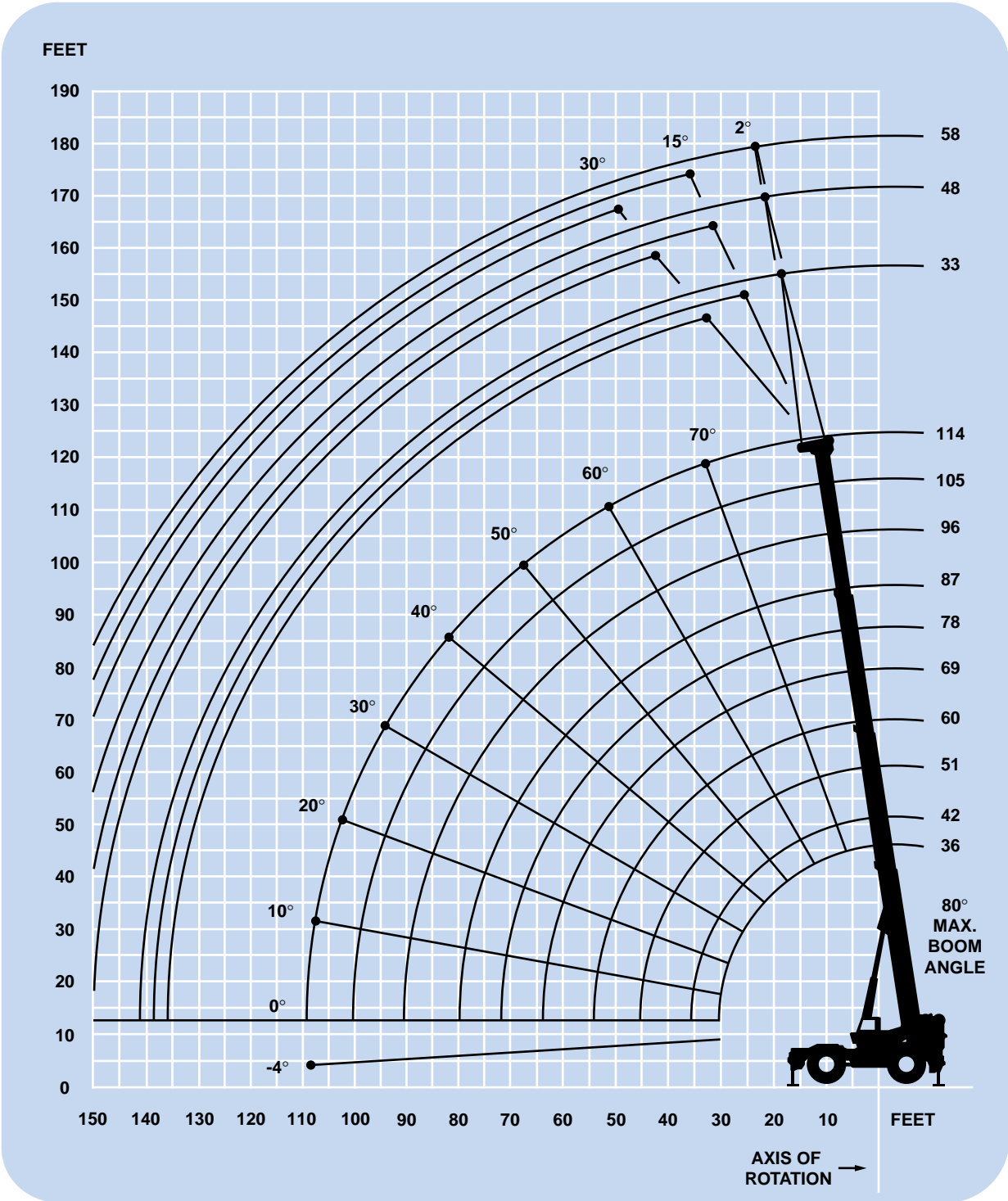

DIMENSIONS ARE FOR LARGEST GROVE FURNISHED HOOK BLOCK AND HEADACHE BALL, WITH ANTI-TWO BLOCK ACTIVATED.

# Superstructure specifications

## Boom

36 ft. - 114 ft. (11.0 m - 34.7 m) four-section, full power boom. Maximum tip height: 124 ft. (37.7 m).

## Lattice Extension

33 ft. (10.0 m) lattice swingaway extension. Offsettable at 2°, 15° or 30°. Stows alongside base boom section. Maximum tip height: 155 ft. (47.2 m).

## \*Optional Lattice Extension

33 ft. - 58 ft. (10.0 m - 17.7 m) telescoping lattice swingaway extension offsettable at 2°, 15° or 30°. Stows alongside base boom section. Maximum tip height: 180 ft. (54.8 m).

## \*Optional Jib

14 ft. (4.3 m) lattice sections combine with a 32 ft. (9.8 m) tip section to provide 46 ft. (14.0 m), 60 ft. (18.2 m), 74 ft. (22.5 m) and 88 ft. (26.8 m) jib lengths. Jib is cable suspended and can be offset at 5°, 17° and 30°. Maximum tip height: 208 ft. (63.4 m).

## Boom Nose

Eight Nylatron sheaves mounted on heavy duty tapered roller bearings with removable pin-type rope guards. Removable auxiliary boom nose with removable pin type rope guard.

## Boom Elevation

Two double acting hydraulic cylinders with integral holding valves provide elevation from -4° to 80°.

## Load Moment & Anti-Two Block System

Standard load moment and anti-two block system with audio-visual warning and control lever lockout. These systems provide electronic display of boom angle, boom length, radius, tip height, relative load moment, maximum permissible load, load indication and warning of impending two-block condition.

## Cab

Full vision, all steel fabricated with acoustical lining and tinted safety glass throughout. Complete driving controls and engine instrumentation. Dash mounted control levers for all craning functions. Other standard features include: hinged skylight, sliding left side door and sliding right side window, electric windshield wash-wipe, low oil pressure/high water temperature A/V warning, propane heater, circulating air fan, fire extinguisher, seat belt and manual skylight wiper.

## Swing

Ball bearing swing circle with 360° continuous rotation. Planetary glide swing with foot applied multi-disc brake. Spring applied, hydraulically released parking

brake, hand operated 360° mechanical house lock, and a one position mechanical pin lock operated from cab. Maximum speed: 2.0 RPM.

## Counterweight

Integral with turntable mast.

Hoist Main only:	17,800 lbs. (8074 kg)
Hoist Main & aux:	15,850 lbs. (7189 kg)

## Hydraulic System

Six main pumps with a combined capacity of 281.5 GPM (1066 LPM).

Maximum operating pressure: 2500 PSI (172.4 bar).

Six individual valve banks.

Return line type filter with full flow by-pass protection and service indicator. Replaceable cartridge with micron filtration rating of 7/17/22.

375 gallon (1419 L) reservoir.

Remote mounted oil cooler with thermostatically controlled hydraulic motor driven fan/air to oil.

System pressure test panel with quick release type fittings for each circuit.

## Hoist Specifications

### Main and Auxiliary Hoist

Planetary reduction with automatic spring applied multi-disc brake. Electronic hoist drum rotation indicator, and hoist drum cable followers.

	HO30B -26G	
	High Range	Low Range
Maximum Single Line Pull: (1st Layer)	7,655 lbs. (3472 kg)	15,309 lbs. (6944 kg)
Maximum Single Line Speed: (5th Layer)	548 FPM (167 m/min)	140 FPM (43 m/min)
Maximum Permissible Line Pull: w/5:1 Strength Factor		12,920 lbs. (5860 kg)
Rope Diameter:		3/4" (19 mm) 18 x 19 Class
Rope Length: Supplied with Basic Std. unit.		800 ft. (24.4 m)
Maximum Rope Stowage: (3/4" 18 x 19 Class)		1,170 ft. (357 m)

*\*Denotes optional equipment*

# Carrier specifications

## Chassis

Box section frame fabricated from high-strength, alloy steel. Integral outrigger housings and front/rear towing and tie down lugs.

## Outrigger System

Four hydraulic telescoping single-stage double box beam outriggers with inverted jacks and integral holding valves. Three position setting. All steel fabricated, quick release type outrigger floats, 30.5" (77.5 mm) diameter.  
Maximum outrigger pad load: 131,203 lbs. (59 513 kg).

## Outrigger Controls

Controls and crane level indicator located in cab.

## Engine

Cummins 6CTA 8.3L diesel, six cylinders, turbocharged, 250 bhp (186 kW) (Gross) @ 2,200 RPM.  
Maximum torque: 794 ft. lbs. (1077 Nm) @ 1,500 RPM.

## \*Optional Engine

Caterpillar 3306TA diesel, six cylinders, turbocharged, 270 bhp (201 kW) (Gross) @ 2,100 RPM.  
Maximum torque: 786 ft. lbs. (1065 Nm) @ 1,400 RPM.

## Fuel Tank Capacity

100 gallons (379 L)

## Transmission

Full powershift with 6 forward and 6 reverse speeds.  
Rear axle disconnect for 4 x 2 travel.

## Electrical System

Two 12-V - maintenance free batteries.  
12 V starting and lighting.

## Drive

4 x 4.

## Steering

Fully independent power steering:  
Front: Full hydraulic steering wheel controlled.  
Rear: Full hydraulic hand lever controlled.  
Provides infinite variations of 4 main steering modes: front only, rear only, crab and coordinated.  
Rear wheel steer indicator.

## Axles

Front: Drive/steer with differential and planetary reduction hubs rigid mounted to chassis.  
Rear: Drive/steer with differential and planetary reduction hubs pivot mounted at the center of chassis. Providing up to 12 in. (305 mm) oscillation.

## Oscillation Lockouts

Automatic full hydraulic lockouts on rear axle permit oscillation only with boom centered over the front.  
Oscillation lockout override control.

## Brakes

Full air split circuit operating on all wheels. Spring-applied, air released parking brake operating on front and rear axles.

## Tires

33.25 x 35 - 32PR (E-3) earthmover type, tubeless.

## Lights

Full lighting including turn indicators, head, tail, brake and hazard warning lights.

## Maximum Speed

16.2 MPH (26 kph).

## Gradeability (Theoretical)

77.2% (Based on 140,000 lbs. [63 492 kg] GVW) 33.25 x 35 tires, pumps disengaged, 36 ft. - 114 ft. (11.0 m - 34.7 m) boom, and 33 ft. (10.0 m) swingaway.

## Miscellaneous Standard Equipment

Full width steel fenders, dual rear view mirrors, electronic back-up alarm, light package, air dryer, hydraulic oil temperature gauge, tire inflation kit.

## \*Optional Equipment

- \*Dual base boom mounted worklights
- \*360° flashing light
- \*Cab spotlight
- \*Engine block heater
- \*Hookblocks/headache balls
- \*Tow winch - front mounted - maximum pull: 15,000 lbs. (6804 kg); maximum speed: 92 ft/min. (28 m/min)
- \*Spare wheel assembly
- \*Tool kit
- \*Pintle hook front/rear
- \*Air conditioning
- \*Emergency steer pump
- \*LMI light bar
- \*Diesel heater/defroster
- \*No-spin differential on rear axle.

*\*Denotes optional equipment*



36 - 114 ft.  
(11.0 - 34.7 m)



17,800 lbs.  
(8074 kg)



100%



360°



Pounds

Feet	36	42	51	60	69	78	87	96	105	114
10	200,000 (67)	121,500 (70.5)	114,000 (74)	107,500 (77)	103,000 (79)					
12	176,000 (63)	120,000 (67.5)	110,000 (71.5)	101,500 (75)	99,300 (77.5)	93,650 (79.5)				
15	151,000 (57.5)	115,000 (63)	102,000 (68)	92,100 (72)	90,250 (75)	84,500 (77)	73,350 (79)			
20	116,000 (47)	99,800 (54.5)	90,050 (61.5)	78,650 (67)	76,850 (70.5)	70,500 (73)	62,750 (75.5)	60,000 (77.5)	56,100 (79)	43,850 (80)
25	88,300 (34)	80,100 (45.5)	73,850 (55)	68,900 (61.5)	66,250 (66)	60,150 (69.5)	54,250 (72)	52,250 (74.5)	48,650 (76)	40,950 (77.5)
30		65,650 (34)	61,400 (47.5)	57,650 (55.5)	55,400 (61)	52,400 (65)	46,900 (68.5)	44,900 (71)	42,900 (73)	35,100 (75)
35		52,500 (16.5)	52,500 (38.5)	49,700 (49.5)	46,600 (56)	44,950 (61)	41,150 (65)	39,200 (68)	37,300 (70)	30,400 (72)
40			41,050 (28.5)	41,050 (42.5)	40,300 (51)	38,550 (56.5)	36,550 (61)	34,650 (64.5)	32,800 (67)	26,650 (69.5)
45				33,100 (34.5)	33,100 (45)	33,100 (52)	32,400 (57)	30,950 (61)	29,150 (64)	23,600 (66.5)
50				27,200 (24)	27,200 (38.5)	27,200 (47)	27,200 (53)	27,200 (57.5)	26,150 (61)	21,350 (63.5)
60					19,200 (20)	19,200 (35)	19,200 (43.5)	19,200 (49.5)	19,200 (54.5)	17,300 (57.5)
70						14,100 (16.5)	14,100 (32)	14,100 (41)	14,100 (47)	14,100 (51.5)
80							10,550 (12.5)	10,550 (29.5)	10,550 (38.5)	10,550 (44)
90								7,770 (27.5)	7,770 (35.5)	
100										5,580 (24.5)
Minimum boom angle (deg.) for indicated length (no load)										0
Maximum boom length (ft.) at 0 deg. boom angle (no load)										114

NOTE: ( ) Boom angles are in degrees.

A6-829-011720

Boom Angle	36	42	51	60	69	78	87	96	105	114
0°	31,400 (30.2)	25,200 (36.3)	18,750 (45.3)	14,200 (54.3)	10,850 (63.3)	8,300 (72.3)	6,250 (81.3)	4,570 (90.3)	3,180 (99.3)	2,060 (107.8)

A6-829-011877



36 - 114 ft.  
(11.0 - 34.7 m)



17,800 lbs.  
(8074 kg)



100%



Over Front



Pounds

Feet	36	42	51	60	69	78	87	96	105	114
10	200,000 (67)	121,500 (70.5)	114,000 (74)	107,500 (77)	103,000 (79)					
12	176,000 (63)	120,000 (67.5)	110,000 (71.5)	101,500 (75)	99,300 (77.5)	93,650 (79.5)				
15	151,000 (57.5)	115,000 (63)	102,000 (68)	92,100 (72)	90,250 (75)	84,500 (77)	73,350 (79)			
20	116,000 (47)	99,800 (54.5)	90,050 (61.5)	78,650 (67)	76,850 (70.5)	70,500 (73)	62,750 (75.5)	60,000 (77.5)	56,100 (79)	43,850 (80)
25	88,300 (34)	80,100 (45.5)	73,850 (55)	68,900 (61.5)	66,250 (66)	60,150 (69.5)	54,250 (72)	52,250 (74.5)	48,650 (76)	40,950 (77.5)
30		65,650 (34)	61,400 (47.5)	57,650 (55.5)	55,400 (61)	52,400 (65)	46,900 (68.5)	44,900 (71)	42,900 (73)	35,100 (75)
35		53,200 (16.5)	53,200 (38.5)	49,700 (49.5)	46,600 (56)	44,950 (61)	41,150 (65)	39,200 (68)	37,300 (70)	30,400 (72)
40			46,750 (28.5)	43,300 (42.5)	40,300 (51)	38,550 (56.5)	36,550 (61)	34,650 (64.5)	32,800 (67)	26,650 (69.5)
45				39,600 (34.5)	35,800 (45)	33,750 (52)	32,400 (57)	30,950 (61)	29,150 (64)	23,600 (66.5)
50				34,750 (24)	32,750 (38.5)	30,150 (47)	28,650 (53)	27,600 (57.5)	26,150 (61)	21,350 (63.5)
60					25,950 (20)	25,850 (35)	23,500 (43.5)	22,100 (49.5)	21,200 (54.5)	17,300 (57.5)
70						19,400 (16.5)	19,400 (32)	18,750 (41)	17,500 (47)	14,150 (51.5)
80							14,850 (12.5)	14,850 (29.5)	14,850 (38.5)	11,700 (44)
90									11,500 (27.5)	9,810 (35.5)
100										8,230 (24.5)
Minimum boom angle (deg.) for indicated length (no load)										0
Maximum boom length (ft.) at 0 deg. boom angle (no load)										114

NOTE: ( ) Boom angles are in degrees.

A6-829-011721



36 - 114 ft.  
(11.0 - 34.7 m)



17,800 lbs.  
(8074 kg)



50%  
17' 8" Spread



360°



Feet	36	42	51	60	69	78	87	96	105	114
10	175,500 (67)	121,500 (70.5)	114,000 (74)	107,500 (77)	103,000 (79)					
12	156,000 (63)	120,000 (67.5)	110,000 (71.5)	101,500 (75)	99,300 (77.5)	93,650 (79.5)				
15	133,500 (57.5)	115,000 (63)	102,000 (68)	92,100 (72)	90,250 (75)	84,500 (77)	73,350 (79)			
20	89,750 (47)	87,400 (54.5)	84,150 (61.5)	78,650 (67)	76,850 (70.5)	70,500 (73)	62,750 (75.5)	60,000 (77.5)	56,100 (79)	43,850 (80)
25	59,550 (34)	59,550 (45.5)	58,900 (55)	57,300 (61.5)	55,700 (66)	54,200 (69.5)	52,750 (72)	51,350 (74.5)	48,650 (76)	40,950 (77.5)
30		42,750 (34)	42,750 (47.5)	42,750 (55.5)	42,100 (61)	41,150 (65)	40,200 (68.5)	39,300 (71)	38,400 (73)	35,100 (75)
35		32,400 (16.5)	32,400 (38.5)	32,400 (49.5)	32,400 (56)	32,300 (61)	31,650 (65)	31,050 (68)	30,400 (70)	29,850 (72)
40			25,350 (28.5)	25,350 (42.5)	25,350 (51)	25,350 (56.5)	25,350 (61)	25,000 (64.5)	24,550 (67)	24,100 (69.5)
45				20,250 (34.5)	20,250 (45)	20,250 (52)	20,250 (57)	20,250 (61)	20,100 (64)	19,750 (66.5)
50				16,400 (24)	16,400 (38.5)	16,400 (47)	16,400 (53)	16,400 (57.5)	16,400 (61)	16,300 (63.5)
60					11,000 (20)	11,000 (35)	11,000 (43.5)	11,000 (49.5)	11,000 (54.5)	11,000 (57.5)
70						7,540 (16.5)	7,540 (32)	7,540 (41)	7,540 (47)	7,540 (51.5)
80							5,040 (12.5)	5,020 (29.5)	4,950 (38.5)	4,870 (44)
90									2,840 (27.5)	2,780 (35.5)
100										1,120 (24.5)

Minimum boom angle (deg.) for indicated length (no load)

0

Maximum boom length (ft.) at 0 deg. boom angle (no load)

114

NOTE: ( ) Boom angles are in degrees.

Boom Angle	36	42	51	60	69	78	87	96	105
0°	31,400 (30.2)	25,200 (36.3)	18,750 (45.3)	13,750 (54.3)	9,600 (63.3)	6,670 (72.3)	4,540 (81.3)	2,860 (90.3)	1,290 (99.3)

NOTE: ( ) Reference radii in feet.

A6-829-013449





36 - 114 ft.  
(11.0 - 34.7 m)



17,800 lbs.  
(8074 kg)



0%  
11' 3-1/2" Spread



360°



Pounds

Feet	36	42	51	60	69	78	87	96	105	114
10	136,500 (67)	121,500 (70.5)	114,000 (74)	107,500 (77)	103,000 (79)					
12	102,000 (63)	98,250 (67.5)	92,950 (71.5)	88,100 (75)	83,650 (77.5)	79,600 (79.5)				
15	67,850 (57.5)	67,850 (63)	67,500 (68)	64,750 (72)	62,150 (75)	59,700 (77)	57,400 (79)			
20	40,700 (47)	40,700 (54.5)	40,700 (61.5)	40,700 (67)	40,700 (70.5)	40,500 (73)	39,250 (75.5)	38,050 (77.5)	36,950 (79)	35,900 (80)
25	27,550 (34)	27,550 (45.5)	27,550 (55)	27,550 (61.5)	27,550 (66)	27,550 (69.5)	27,550 (72)	27,550 (74.5)	27,050 (76)	26,400 (77.5)
30		19,800 (34)	19,800 (47.5)	19,800 (55.5)	19,800 (61)	19,800 (65)	19,800 (68.5)	19,800 (71)	19,800 (73)	19,800 (75)
35		14,700 (16.5)	14,700 (38.5)	14,700 (49.5)	14,700 (56)	14,700 (61)	14,700 (65)	14,700 (68)	14,700 (70)	14,700 (72)
40			11,050 (28.5)	11,050 (42.5)	11,050 (51)	11,050 (56.5)	11,050 (61)	11,050 (64.5)	11,050 (67)	11,050 (69.5)
45				8,380 (34.5)	8,380 (45)	8,380 (52)	8,380 (57)	8,380 (61)	8,380 (64)	8,380 (66.5)
50				6,290 (24)	6,290 (38.5)	6,290 (47)	6,290 (53)	6,290 (57.5)	6,290 (61)	6,290 (63.5)
60					3,320 (20)	3,320 (35)	3,320 (43.5)	3,320 (49.5)	3,320 (54.5)	3,320 (57.5)
70						1,250 (16.5)	1,290 (32)	1,270 (41)	1,230 (47)	1,170 (51.5)
Minimum boom angle (deg.) for indicated length (no load)										46.5
Maximum boom length (ft.) at 0 deg. boom angle (no load)										69

NOTE: ( ) Boom angles are in degrees.

Boom Angle	36	42	51	60	69
0°	19,550 (30.2)	13,650 (36.3)	8,270 (45.3)	4,850 (54.3)	2,500 (63.3)

NOTE: ( ) Reference radii in feet.

A6-829-013450

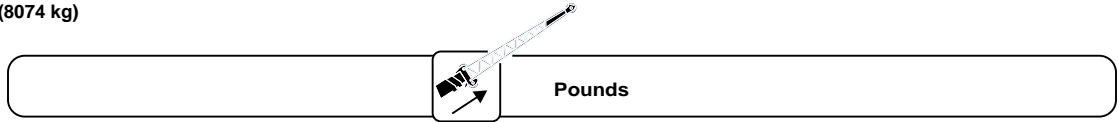
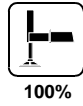
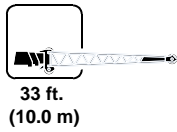

Feet	2° OFFSET	15° OFFSET	30° OFFSET
25	*25,000 (80)		
30	23,800 (79)	*17,150 (80)	
35	21,650 (77)	16,500 (79.5)	
40	19,850 (75)	14,800 (77.5)	12,550 (80)
45	18,450 (72.5)	13,250 (75)	11,500 (78)
50	17,350 (70.5)	12,000 (73)	10,550 (75.5)
60	13,950 (66)	10,100 (68.5)	9,050 (71)
70	11,250 (61.5)	8,630 (64)	7,850 (66.5)
80	9,350 (57)	7,420 (59)	6,860 (61.5)
90	7,860 (51.5)	6,440 (54)	6,040 (56.5)
100	6,650 (46)	5,620 (48.5)	5,350 (50.5)
110	5,520 (40)	4,920 (42.5)	4,760 (44)
120	4,010 (33.5)	4,010 (35)	4,010 (36.5)

NOTE: ( ) Boom angles are in degrees.  
 \*This capacity is based upon maximum boom angle.

A6-829-011881

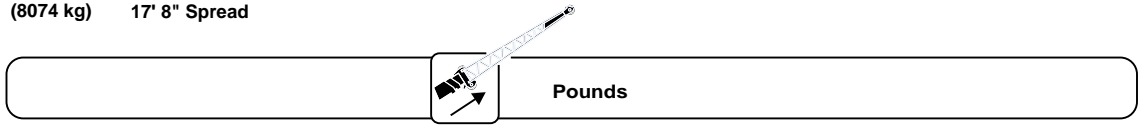
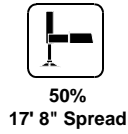
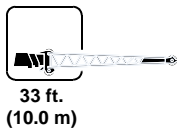

Feet	2° OFFSET	15° OFFSET	30° OFFSET
25	*25,000 (80)		
30	23,800 (79)	*17,150 (80)	
35	21,650 (77)	16,500 (79.5)	
40	19,850 (75)	14,800 (77.5)	12,550 (80)
45	18,450 (72.5)	13,250 (75)	11,500 (78)
50	16,800 (70.5)	12,000 (73)	10,550 (75.5)
60	11,950 (66)	10,100 (68.5)	9,050 (71)
70	8,480 (61.5)	8,480 (64)	7,850 (66.5)
80	5,880 (57)	5,880 (59)	5,880 (61.5)
90	3,860 (51.5)	3,860 (54)	3,860 (56.5)
100	2,250 (46)	2,250 (48.5)	2,250 (50.5)

NOTE: ( ) Boom angles are in degrees.  
 \*This capacity is based upon maximum boom angle.

A6-829-013451A

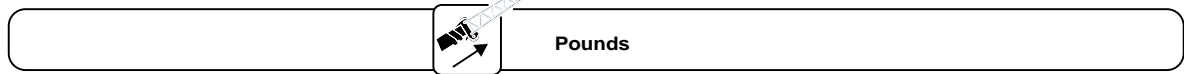
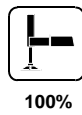
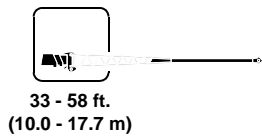

Feet	33 ft. LENGTH			48 ft. LENGTH			58 ft. LENGTH		
	2° OFFSET	15° OFFSET	30° OFFSET	2° OFFSET	15° OFFSET	30° OFFSET	2° OFFSET	15° OFFSET	30° OFFSET
25	*24,500 (80)								
30	23,250 (79)	*16,600 (80)		*16,900 (80)			*11,000 (80)		
35	21,100 (77)	15,950 (79.5)		15,600 (79)			10,850 (79.5)		
40	19,300 (75)	14,250 (77.5)	12,000 (80)	13,850 (77)	*11,000 (80)		10,400 (78)		
45	17,900 (72.5)	12,750 (75)	10,950 (78)	12,300 (75)	10,150 (78.5)		10,000 (76)	*8,580 (80)	
50	16,800 (70.5)	11,450 (73)	10,000 (75.5)	11,000 (73)	9,260 (76.5)	*7,890 (80)	9,380 (74.5)	8,040 (78.5)	*6,140 (80)
60	13,450 (66)	9,570 (68.5)	8,510 (71)	9,030 (69)	7,750 (72.5)	6,790 (76)	7,750 (70.5)	6,780 (75)	5,940 (79)
70	10,700 (61.5)	8,080 (64)	7,310 (66.5)	7,510 (65)	6,590 (68.5)	5,880 (72)	6,510 (67)	5,800 (71.5)	5,160 (75.5)
80	8,810 (57)	6,870 (59)	6,320 (61.5)	6,320 (61)	5,640 (64.5)	5,130 (67.5)	5,550 (63)	5,010 (67.5)	4,520 (71.5)
90	7,310 (51.5)	5,900 (54)	5,490 (56.5)	5,380 (56.5)	4,870 (60)	4,490 (63)	4,760 (59.5)	4,350 (63.5)	3,980 (67)
100	6,100 (46)	5,080 (48.5)	4,800 (50.5)	4,610 (52)	4,230 (55)	3,950 (58)	4,110 (55)	3,790 (59)	3,510 (62.5)
110	4,820 (40)	4,380 (42.5)	4,210 (44)	3,970 (47)	3,690 (50)	3,480 (53)	3,560 (50.5)	3,320 (54.5)	3,100 (58)
120	3,230 (33.5)	3,230 (35)	3,230 (36.5)	3,430 (41.5)	3,210 (44.5)	3,090 (47)	3,100 (46)	2,910 (49.5)	2,750 (52.5)
130				2,940 (35.5)	2,810 (38)	2,740 (40.5)	2,700 (41)	2,560 (44.5)	2,440 (47)
140				2,030 (29)	2,030 (31)	2,030 (32.5)	2,340 (35)	2,250 (38.5)	2,180 (40)
150							1,800 (29.5)	1,800 (31.5)	1,800 (32.5)

NOTE: ( ) Boom angles are in degrees.  
 \*This capacity is based upon maximum boom angle.

A6-829-011876A

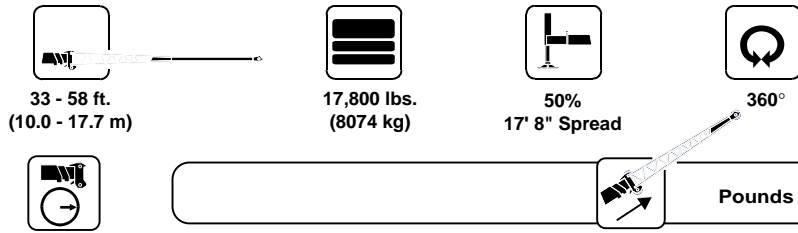

Feet	33 ft. LENGTH			48 ft. LENGTH			58 ft. LENGTH		
	2° OFFSET	15° OFFSET	30° OFFSET	2° OFFSET	15° OFFSET	30° OFFSET	2° OFFSET	15° OFFSET	30° OFFSET
25	*24,500 (80)								
30	23,250 (79)	*16,600 (80)		*16,900 (80)			*11,000 (80)		
35	21,100 (77)	15,950 (79.5)		15,600 (79)			10,850 (79.5)		
40	19,300 (75)	14,250 (77.5)	12,000 (80)	13,850 (77)	*11,000 (80)		10,400 (78)		
45	17,900 (72.5)	12,750 (75)	10,950 (78)	12,300 (75)	10,150 (78.5)		10,000 (76)	*8,580 (80)	
50	15,900 (70.5)	11,450 (73)	10,000 (75.5)	11,000 (73)	9,260 (76.5)	*7,890 (80)	9,380 (74.5)	8,040 (78.5)	*6,140 (80)
60	11,050 (66)	9,570 (68.5)	8,510 (71)	9,030 (69)	7,750 (72.5)	6,790 (76)	7,750 (70.5)	6,780 (75)	5,940 (79)
70	7,570 (61.5)	7,570 (64)	7,310 (66.5)	7,510 (65)	6,590 (68.5)	5,880 (72)	6,510 (67)	5,800 (71.5)	5,160 (75.5)
80	4,970 (57)	4,970 (59)	4,970 (61.5)	6,160 (61)	5,640 (64.5)	5,130 (67.5)	5,550 (63)	5,010 (67.5)	4,520 (71.5)
90	2,940 (51.5)	2,940 (54)	2,940 (56.5)	4,150 (56.5)	4,150 (60)	4,150 (63)	4,760 (59.5)	4,350 (63.5)	3,980 (67)
100	1,330 (46)	1,330 (48.5)	1,330 (50.5)	2,540 (52)	2,540 (55)	2,540 (58)	3,210 (55)	3,210 (59)	3,210 (62.5)
110				1,220 (47)	1,220 (50)	1,220 (53)	1,890 (50.5)	1,890 (54.5)	1,890 (58)

NOTE: ( ) Boom angles are in degrees.  
\*This capacity is based upon maximum boom angle.

A6-829-013452A



36 -114 ft.  
(11.0 - 34.47 m)



17,800 lbs.  
(8074 kg)



33.25 x 35  
Stationary



360°



Pounds

Feet	36	42	51	60	69	78	87
10	94,050 (67)	94,050 (70.5)	94,050 (74)				
12	77,250 (63)	77,250 (67.5)	77,250 (71.5)	77,250 (75)			
15	54,050 (57.5)	54,050 (63)	54,050 (68)	54,050 (72)	54,050 (75)		
20	32,150 (47)	32,150 (54.5)	32,150 (61.5)	32,150 (67)	32,150 (70.5)	24,550 (73)	
25	21,050 (34)	21,050 (45.5)	21,050 (55)	21,050 (61.5)	21,050 (66)	21,050 (69.5)	19,600 (72)
30		14,350 (34)	14,350 (47.5)	14,350 (55.5)	14,350 (61)	14,350 (65)	14,350 (68.5)
35		10,300 (16.5)	10,300 (38.5)	10,300 (49.5)	10,300 (56)	10,300 (61)	10,300 (65)
40			7,440 (28.5)	7,440 (42.5)	7,440 (51)	7,440 (56.5)	7,440 (61)
45				5,260 (34.5)	5,260 (45)	5,260 (52)	5,260 (57)
50				3,570 (24)	3,570 (38.5)	3,570 (47)	3,570 (53)
60					1,100 (20)	1,100 (35)	1,100 (43.5)

NOTE: ( ) Boom angles are in degrees.

A6-829-011866

Boom Angle	36	42	51	60
0°	14,150 (30.2)	9,520 (36.3)	5,170 (45.3)	2,400 (54.3)

A6-829-011877



36 - 114 ft.  
(11.0 - 34.7 m)



17,800 lbs.  
(8074 kg)



33.25 x 35  
Stationary



Defined Arc  
Over Front  
±6°



Pounds

Feet	36	42	51	60	69	78	87	96	105	114
10	94,050 (67)	94,050 (70.5)	94,050 (74)							
12	88,150 (63)	77,250 (67.5)	77,250 (71.5)	77,250 (75)						
15	79,650 (57.5)	56,100 (63)	56,100 (68)	56,100 (72)	56,100 (75)					
20	66,150 (47)	54,750 (54.5)	54,750 (61.5)	48,550 (67)	36,450 (70.5)	24,550 (73)				
25	51,050 (34)	51,050 (45.5)	51,050 (55)	43,700 (61.5)	34,750 (66)	24,550 (69.5)	19,600 (72)			
30		36,450 (34)	36,450 (47.5)	36,450 (55.5)	33,050 (61)	24,550 (65)	19,600 (68.5)			
35		27,650 (16.5)	27,650 (38.5)	27,650 (49.5)	27,650 (56)	24,550 (61)	19,600 (65)			
40			21,650 (28.5)	21,650 (42.5)	21,650 (51)	21,650 (56.5)	19,600 (61)			
45				17,300 (34.5)	17,300 (45)	17,300 (52)	17,300 (57)	17,300 (61)		
50				14,000 (24)	14,000 (38.5)	14,000 (47)	14,000 (53)	14,000 (57.5)	14,000 (61)	14,000 (63.5)
60					9,370 (20)	9,370 (35)	9,370 (43.5)	9,370 (49.5)	9,370 (54.5)	9,370 (57.5)
70						6,220 (16.5)	6,220 (32)	6,220 (41)	6,220 (47)	6,220 (51.5)
80							3,950 (12.5)	3,950 (29.5)	3,950 (38.5)	3,950 (44)
90								2,240 (27.5)	2,240 (35.5)	

NOTE: ( ) Boom angles are in degrees.

A6-829-011865

Boom Angle	36	42	51	60	69	78	87	96
0°	31,400 (30.2)	25,200 (36.3)	17,150 (45.3)	11,800 (54.3)	8,220 (63.3)	5,650 (72.3)	3,710 (81.3)	2,210 (90.3)

A6-829-011877



36 - 114 ft.  
(11.0 - 34.7 m)



17,800 lbs.  
(8074 kg)



33.25 x 35  
Pick & Carry  
Up to 2.5 MPH



Boom Centered  
Over Front



Feet	36	42	51	60	69	78	87	96	105	114
10	104,500 (67)									
12	99,800 (63)	77,250 (67.5)								
15	84,000 (57.5)	72,800 (63)								
20	65,450 (47)	65,450 (54.5)								
25	51,050 (34)	51,050 (45.5)	51,050 (55)	51,050 (61.5)	51,050 (66)					
30		36,450 (34)	36,450 (47.5)	36,450 (55.5)	36,450 (61)					
35		22,300 (16.5)	22,300 (38.5)	22,300 (49.5)	22,300 (56)	22,300 (61)	22,300 (65)	22,300 (68)		
40			18,500 (28.5)	18,500 (42.5)	18,500 (51)	18,500 (56.5)	18,500 (61)	18,500 (64.5)	18,500 (67)	18,500 (69.5)
45				15,450 (34.5)	15,450 (45)	15,450 (52)	15,450 (57)	15,450 (61)	15,450 (64)	15,450 (66.5)
50				12,900 (24)	12,900 (38.5)	12,900 (47)	12,900 (53)	12,900 (57.5)	12,900 (61)	12,900 (63.5)
60					9,010 (20)	9,010 (35)	9,010 (43.5)	9,010 (49.5)	9,010 (54.5)	9,010 (57.5)
70						6,110 (16.5)	6,110 (32)	6,110 (41)	6,110 (47)	6,110 (51.5)
80							3,880 (12.5)	3,880 (29.5)	3,880 (38.5)	3,880 (44)
90								2,110 (7)	2,110 (27.5)	2,110 (35.5)

NOTE: ( ) Boom angles are in degrees.

A6-829-011867

Boom Angle	36	42	51	60	69	78	87	96
0°	26,950 (30.2)	21,300 (36.3)	15,300 (45.3)	11,100 (54.3)	7,980 (63.3)	5,560 (72.3)	3,630 (81.3)	2,070 (90.3)

A6-829-011877



# Working range



36 - 114 ft.  
(11.0 - 34.7 m)

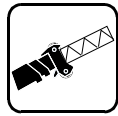

46 - 88 ft.  
(14.0 - 26.8 m)



17,800 lbs.  
(8074 kg)

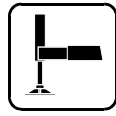

100%



360°

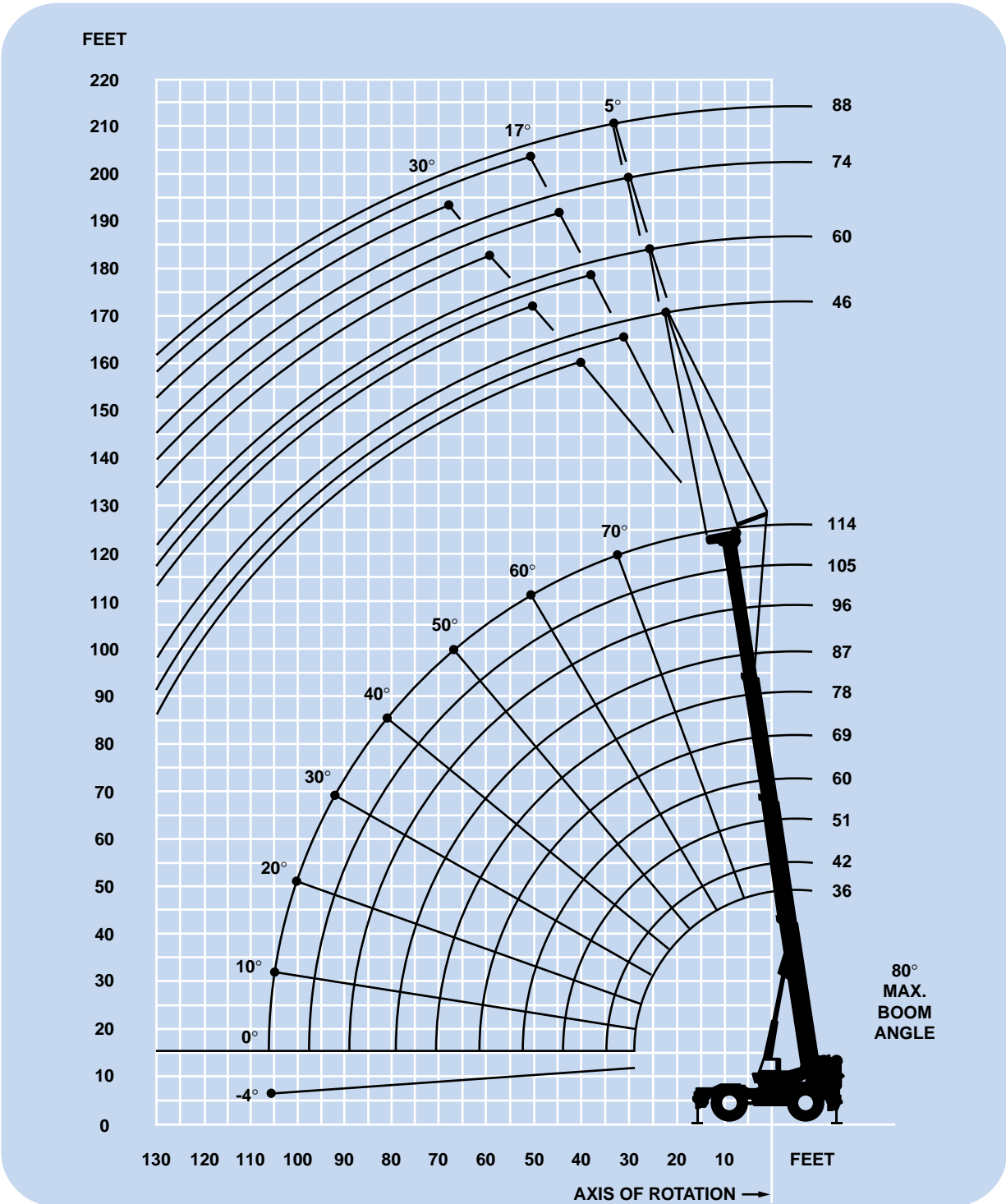

3'-6"

7'-6"

**DIMENSIONS ARE FOR LARGEST GROVE FURNISHED HOOKBLOCK AND HEADACHE BALL, WITH ANTI-TWO BLOCK ACTIVATED.**



46 - 88 ft.  
(14.0 - 26.8 m)



17,800 lbs.  
(8074 kg)



100%



360°



Pounds

Main Boom Angle (Deg.)	46 FT. JIB						60 FT. JIB					
	5° OFFSET		17° OFFSET		30° OFFSET		5° OFFSET		17° OFFSET		30° OFFSET	
	Rad. Ref. (ft.)*	Cap. lbs.**	Rad. Ref. (ft.)*	Cap. lbs.**	Rad. Ref. (ft.)*	Cap. lbs.**	Rad. Ref. (ft.)*	Cap. lbs.**	Rad. Ref. (ft.)*	Cap. lbs.**	Rad. Ref. (ft.)*	Cap. lbs.**
80	31.3	17,800	41.4	15,100	50.1	10,700	36.4	13,400	48.9	10,300	59.4	7,170
77.5	38.1	16,900	47.8	14,600	56.1	10,200	43.6	12,600	55.8	9,840	66.1	6,720
75	44.8	16,200	54.1	14,100	62.1	9,710	50.7	12,000	62.7	9,400	72.7	6,340
72.5	51.2	15,500	60.2	13,600	67.9	9,280	57.8	11,300	69.4	9,000	79.0	6,010
70	57.8	14,900	66.3	13,200	73.7	8,870	64.7	10,800	76.0	8,630	85.3	5,730
67.5	64.1	13,300	72.2	11,500	79.2	8,510	71.4	10,200	82.4	8,300	91.4	5,480
65	70.3	11,200	78.0	9,940	84.7	8,170	78.1	9,630	88.8	8,000	97.3	5,260
62.5	76.4	9,580	83.7	8,580	89.9	7,860	84.6	8,180	94.8	7,160	103.1	5,060
60	82.4	8,220	89.2	7,440	95.0	6,890	90.9	6,990	100.8	6,200	108.7	4,890
55	93.8	6,150	99.6	5,660	104.7	5,330	103.2	5,170	112.1	4,670	119.1	4,330
50	104.6	4,650	109.3	4,340	113.5	4,140	114.5	3,840	122.6	3,520		
45	114.5	3,540	118.2	3,340	121.4	3,210						

Main Boom Angle (Deg.)	74 FT. JIB						88 FT. JIB					
	5° OFFSET		17° OFFSET		30° OFFSET		5° OFFSET		17° OFFSET		30° OFFSET	
	Rad. Ref. (ft.)*	Cap. lbs.**	Rad. Ref. (ft.)*	Cap. lbs.**	Rad. Ref. (ft.)*	Cap. lbs.**	Rad. Ref. (ft.)*	Cap. lbs.**	Rad. Ref. (ft.)*	Cap. lbs.**	Rad. Ref. (ft.)*	Cap. lbs.**
80	39.8	10,300	55.0	7,380	68.8	5,230	44.3	7,960	62.4	5,110	78.8	3,170
77.5	47.8	9,620	62.7	6,920	75.8	4,870	52.7	7,260	70.2	4,670	85.9	2,900
75	55.8	8,960	70.2	6,500	82.5	4,550	60.9	6,620	78.0	4,270	92.9	2,650
72.5	63.5	8,360	77.6	6,120	89.2	4,280	69.1	6,050	85.6	3,910	99.7	2,430
70	71.2	7,820	84.8	5,780	95.8	4,030	77.1	5,530	93.1	3,570	106.3	2,220
67.5	78.8	7,330	92.0	5,460	102.1	3,820	84.9	5,050	100.3	3,250	112.8	2,040
65	86.2	6,880	98.9	5,170	108.2	3,630	92.7	4,620	107.4	2,950	119.0	1,880
62.5	93.4	6,470	105.7	4,910	114.1	3,460	100.2	4,230	114.3	2,660	124.9	1,730
60	100.5	5,970	112.2	4,670	119.8	3,300	107.6	3,870	121.0	2,400		
55	114.1	4,330	124.7	3,840			121.7	3,240				

\*Reference radius refers to fully extended boom and appropriate jib length.

\*\*Capacities at loaded main boom angle.

A6-829-004518C

**NOTES:**

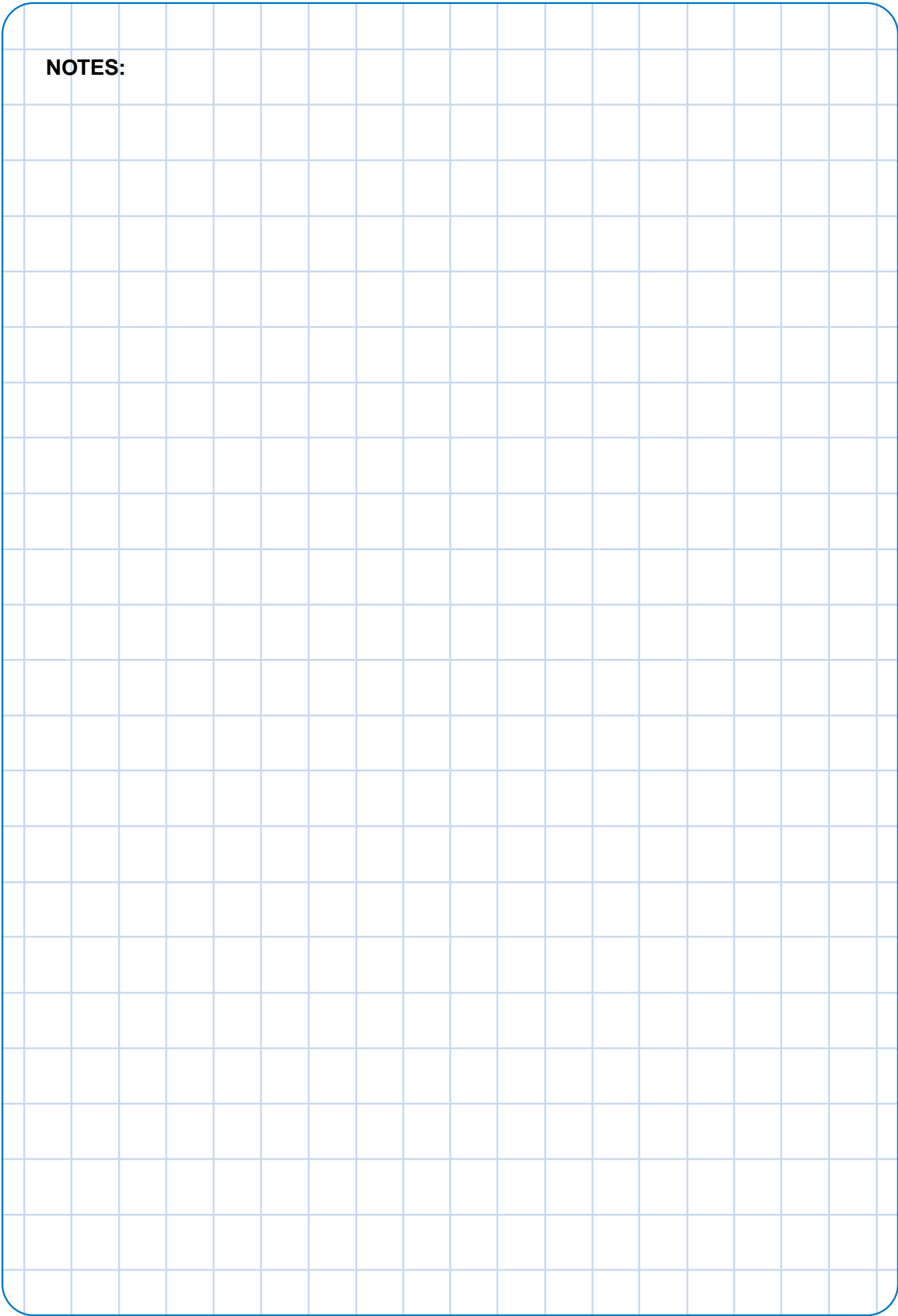

**NOTES:**

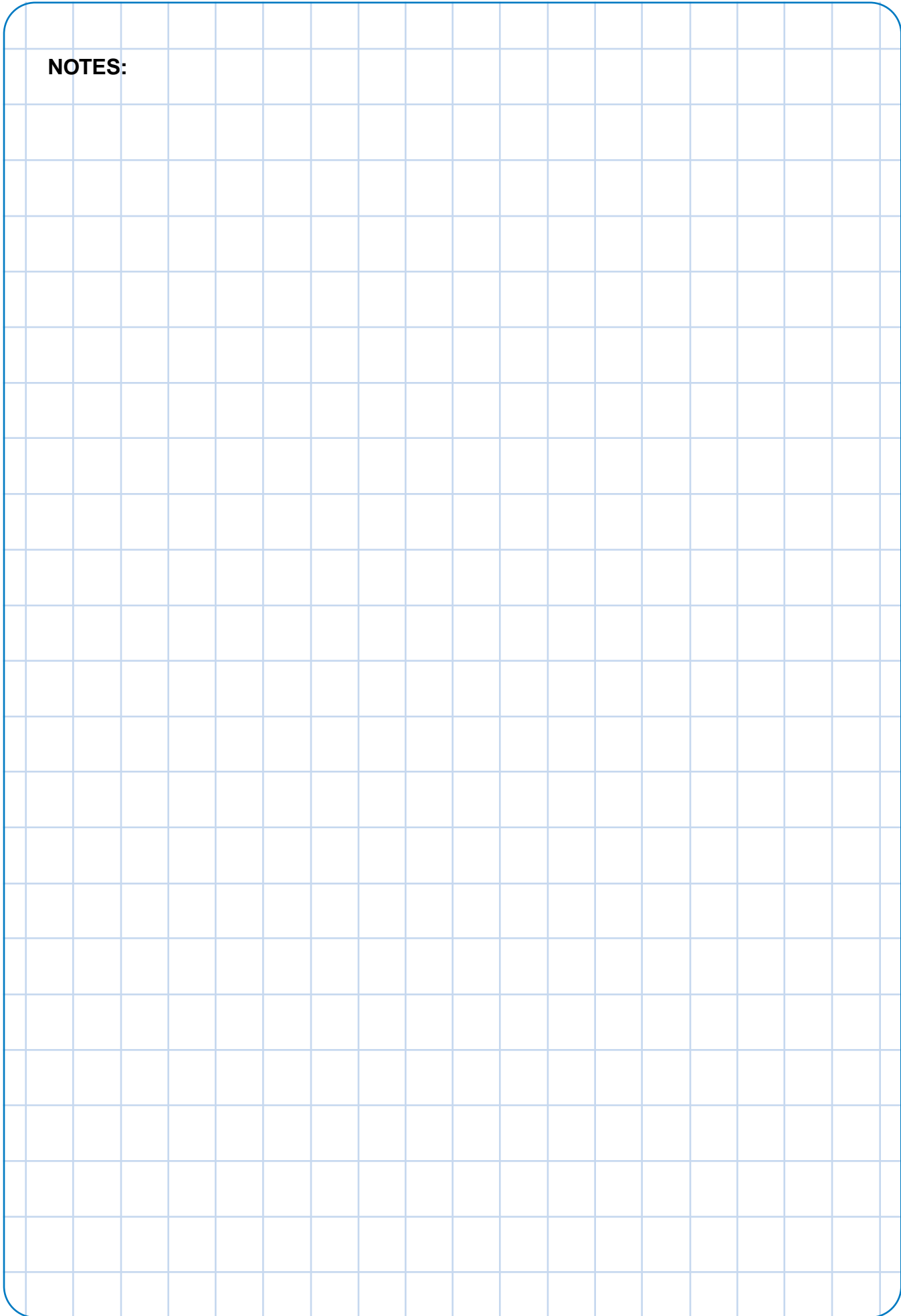

# Rated lifting capacities

## NOTES FOR LIFTING CAPACITIES

**WARNING: THIS CHART IS ONLY A GUIDE.**  
**The notes below are for illustration only and should not be relied upon to operate the crane.**  
**The individual crane's load chart, operating instructions and other instruction plates must be read and understood prior to operating the crane.**

1. All rated loads have been tested to and meet minimum requirements of SAEJ1063OCT80 - Cantilevered Boom Crane Structures - Method of Test, and do not exceed 85% of the tipping load on outriggers fully and 50% extended, and 75% on outriggers 0% extended (fully retracted) as determined by SAEJ765OCT80 Crane Stability Test Code.

2. Rated loads include the weight of hookblock, slings and auxiliary lifting devices and their weights shall be subtracted from the listed rating to obtain the net load to be lifted. When more than the minimum required hoist reeving is used, the additional rope weight shall be considered part of the load to be handled.

3. Capacities appearing above the bold line are based on structural strength and tipping should not be relied upon as a capacity limitation.





































4. The machine shall be leveled on a firm supporting surface. Depending on the nature of the surface, it may be necessary to have structural supports under the outrigger floats or tires to spread the load to a larger bearing surface.

5. When either boom length or radius or both are between values listed, the smallest load shown at either the next larger radius or next longer or shorter boom length shall be used.

6. Tires shall be inflated to the recommended pressure before lifting on rubber.

7. For outrigger operation, outriggers shall be properly extended with tires raised free of crane weight before operating the boom or lifting loads.

# Symbols Glossary

	Frame		Steering
	Outriggers		Transmission
	Outrigger Controls		Axles
	Engine		Brakes
	Fuel Tank Capacity		Tires
	Electrical System		Suspension
	Drive		Rotation
	Lights		Boom Elevation
	Cab		Swing
	Boom		Counterweight
	Fixed Swingaway		Oil
	Tele-Swingaway		Hydraulic System
	Jib		Hoist
	Boom Nose		Radius
	Boom Extension		Boom Length
	Speed		Hookblock
	Grade		Gear
	Lattice Extension		Luffing Jib

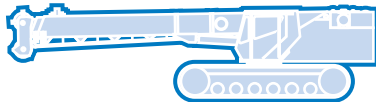
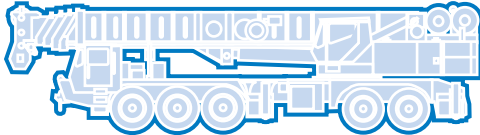
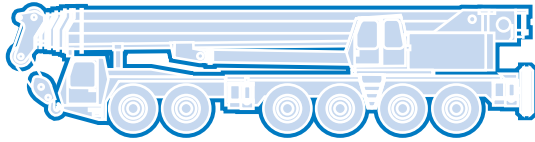
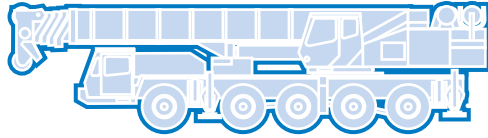

**GROVE**<sup>®</sup>  
worldwide

**Grove Worldwide – World Headquarters**

**Grove North America**  
1565 Buchanan Trail East  
P.O. Box 21  
Shady Grove, Pennsylvania 17256, U.S.A.  
Tel: [Int + 1] (717) 597-8121  
Fax: [Int + 1] (717) 597-4062  
Western Hemisphere, Asia/Pacific

**Grove Europe Limited\***

Sunderland SR4 6TT, England  
Tel: [Int + 44] 191 565-6281  
Fax: [Int + 44] 191 564-0442  
Europe, Africa, Middle East

**Grove Europe Limited\***

P.O. Box No. 268  
4A Kimber Road  
Abingdon, Oxfordshire, OX141SG  
Tel: [Int + 44] 1235 55-3184  
Fax: [Int + 44] 1235 55-3218

\*Grove Europe Limited, Registered in England,  
Number 1845128, Registered office, Crown Works,  
Pallion, Sunderland, Tyne & Wear, England SR4 6TT

**Deutsche Grove GmbH**

**Sales and Service**  
Helmholtzstrasse 12, Postfach 5026  
D-40750 Langenfeld, Germany  
Tel: [Int + 49] (2173) 8909-0  
Fax: [Int + 49] (2173) 8909-30

**Wilhelmshaven Works**

Industriegelände West, Postfach 1853  
D-26358 Wilhelmshaven, Germany  
Tel: [Int + 49] (4421) 294-0  
Fax: [Int + 49] (4421) 294-301

**Grove France S.A.**

16, chaussée Jules-César, 95520 OSNY  
B.P. 203, 95523 CERGY PONTOISE CEDEX  
France  
Tel: [Int + 33] (1) 30313150  
Int: [Int + 33] (1) 30386085

**Grove Asia/Pacific - Regional Office**

171 Chin Swee Road  
#06-01 San Centre  
Singapore 0316  
Tel: [Int + 65] 536-6112  
Fax: [Int + 65] 536-6119  
Asia/Pacific, Near East

**Grove China - Representative Office**

Beijing Suite 6074  
No. 33 East Chang An Avenue  
Beijing, 100004, China  
Tel: [Int + 86] (10) 513-7766  
Fax: [Int + 86] (10) 513-7307

**Grove Product Support**

Western Hemisphere, Asia/Pacific  
1086 Wayne Avenue  
Chambersburg, Pennsylvania USA  
Tel: [Int + 1] (717) 263-5100  
Fax: [Int + 1] (717) 267-0404

Europe, Africa, Middle East  
Sunderland SR4 6TT, England  
Tel: [Int + 44] 191 565-6281  
Parts Fax: [Int + 44] 191 510-9242  
Service Fax: [Int + 44] 191 510-9560

<http://www.grovetworldwide.com>

Constant improvement and engineering progress make it necessary that we reserve the right to make specification, equipment, and price changes without notice. Illustrations shown may include optional equipment and accessories and may not include all standard equipment.

Distributed By: