



RT35

RT35 PRODUCT GUIDE

Complies with ANSI B30.5

Rough Terrain Crane

35 metric ton (38.6 ton lift capacity)

31 m (101.7' main boom)

9 m - 14 m (29.5' - 46' jib)



CONTENTS

2 FEATURES

3 KEY / SYMBOLS

4-6 TECHNICAL DESCRIPTION

7 CRANE AND COMPONENT WEIGHTS

8 CRANE DIMENSIONS

9 WORKING RANGE DIAGRAM

10-13 LOAD CHARTS



HEADQUARTERS

Global Machinery & Equipment, LLC.
14800 Jersey Shore Drive, Houston, TX 77047 USA
Phone: +1 (713) 586-8808 | Fax: +1 (713) 586-8805
Info@globalcranesales.com | www.globalcranesales.com

FEATURES



Formed boom made with high-yield steel which reduces the operating weight of the boom and maximizes performance.



We chose the AxleTech brand axle because AxleTech offers the most reliable product on the market and has years of experience in manufacturing mobile crane axles.



Full vision operator cab is designed for maximum comfort and ease of operation.



The Dana transmission offers the latest technology for the diverse needs of off-road cranes.

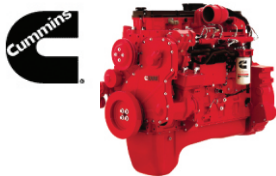

The Cummins QSB 6.7 diesel engine is TIER-III compliant and is proven to have superior performance and durability.

Greer RCI 777 LMI (load moment indicator) delivers the industry's most reliable electronic monitoring system available.























STANDARD EQUIPMENT

- Formed boom
- Offsettable jib 0° - 20° - 40°
- Auxiliary winch
- Cameras
- Auxiliary lifting sheave
- 35 ton hook block
- 6.1 ton hook ball
- Rotation resistant wire rope
- Deluxe tilt seat
- Air conditioner / Heater
- Work light package: boom, cab and super structure
- Revolving amber light
- AM/FM radio
- Battery disconnect switch
- Front and rear lift lugs

ANSI & CE certified

KEY / SYMBOLS

	Engine	p4		Load Moment Indicator (LMI)	p5
	Transmission	p4		Max. boom length with jib ext.	p5
	Axles	p4		Main boom	p6
	Steering	p4		Main and auxiliary winches	p6
	Gradeability	p4		Cameras	p6
	Brakes	p4		Hook block	p6
	Tires and wheels	p4		Hook ball	p6
	Outrigger system (100%, 50%, 0% extended)	p4		Crane with counterweight	p7
	Hydraulic system	p5		Side stowed jib	p7
	Operator cab	p5		Distance from the hook to the head	p8
	Counterweight	p5		Tip height	p9
	Swing	p5		Working radius	p9

TECHNICAL DESCRIPTION



ENGINE

Cummins QSB 6.7 Inline 6 cylinder intercooled turbo diesel.
 Horsepower Hp (kW) 173 (129) @ 2200 rpm.
 Peak torque ft. lb. (Nm) 589 (799) @ 1400 rpm.
 80 gallon (303 L) fuel tank capacity.

USA Federal EPA / California ARB / European EU / Tier III emission rating.

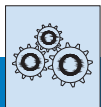

TRANSMISSION

Dana powershift transmission - 6 speeds forward and 3 speeds reverse.
 Front axle disconnect offering both 4x4 and 4x2 operation.
 Max. speed 23.6 mph (38 km/hr).



AXLES

AxleTech front and rear steering axles with planetary reduction.

Front - Rigid mount.

Rear - Full floating rear axle. Automatic rear axle oscillating lock occurs when superstructure is swung 10° from centerline in either direction.



STEERING

Power steering with four independent modes.

- Front-Wheel
- Rear-Wheel
- All-Wheel
- Crab

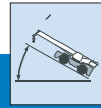

GRADEABILITY

57% max. gradeability in 1st gear 4x4.
 2.5% max. gradeability in 6th gear 4x2.



BRAKES

18.5 inches (470 mm) diameter disc brakes on all wheels hydraulically operated.



TIRES AND WHEELS

20.5 x 25 - 28 ply rating, earthmoving style tires. Steel disc wheels.

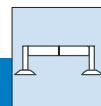

OUTRIGGER SYSTEM

Four independent horizontal beams and vertical jacks with integral holding valves, each independently controlled from operator cab.

- 100% - Fully extended outriggers
 footprint 498.4 sq. ft. (46.3 sq. m).
- 50% - Mid position outriggers
 footprint 351.9 sq. ft. (32.7 sq. m).
- 0% - Fully retracted outriggers
 footprint 205 sq. ft. (19 sq. m).
- Light-weight steel, quick-release outrigger pontoons.
- Floating ground bearing area 23.6 in. (0.6 m) (418.5 sq. in.) (38.9 sq. m).
- Outrigger span Length 22.3 ft. (6.8 m).
 Width 22.3 ft. (6.8 m).

TECHNICAL DESCRIPTION



HYDRAULIC SYSTEM

Hydraulic pumps.
 Gear pump for main and auxiliary winches, boom hoist and telescope cylinders.
 Gear pump for steering.
 Gear pump for outriggers and slewing.
 158.5 gallon (600 L) hydraulic reservoir with external sight and temperature gauge.

Easily accessible (10 micron) cartridge style full flow filters with bypass protection.
 Max. operating pressure: 27MPa (3916 psi, 270 bar).



OPERATOR CAB

Full vision operator cab designed for max. comfort. All steel fabrication with acoustical lining and safety glass throughout. The cab has a sliding door on the left and a sliding window on the right side with a swing-up skylight with retractable shade and wiper motor. Fully adjustable deluxe seat with tilt. Foot controls for boom telescope, service brake and engine throttle. Tilt steering.

Temperature control is provided by a hydraulically driven air conditioning unit. Easy view dashboard with gauges for all engine sensors and rocker switch outrigger controls. Standard amenities also include bubble level, dome light, left side rearview mirror, seat belt, travel swing lock and signal horn.



COUNTERWEIGHT

Single 9,921 lb. (4500 kg) fixed counterweight.
 Length 9.7 ft. (2.9 m).
 Width 2.8 ft. (0.9 m).
 Height 2.8 ft. (0.9 m).



SWING

Bi-directional hydraulic swing drive with multi-disc wet brake and planetary reduction gearbox. Spring applied hydraulically released swing brake and 360° pneumatic positive swing lock.
 Max. swing speed: 2.5 rpm.



LOAD MOMENT INDICATOR (LMI)

GREER RCI 777 LMI control system. Microguard graphic display load moment and anti-two block system with audio-visual warning and function limiter.

System displays the following information: crane configuration, boom length, boom angle, load radius, allowed capacity, actual load, and load percentage of allowed capacity.

System includes settable work parameters: min./max. boom length, min./max. boom angle, defined swing area.

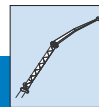

MAX. BOOM LENGTH WITH JIB EXTENSION

29.5-49.2 ft. (9-15 m) jib consisting of 29.5 ft. (9 m) lattice side stow jib and 19.7 ft. (6 m) manual pull out section. Main jib is offsettable at 0°, 20° and 40°.
 Max. tip height with 29.5 ft. (9 m) jib erected is 134.5 ft. (41 m).
 Max. tip height with 29.5 ft. (9 m) jib + 19.7 ft. (6 m) fixed pullout extension is 151 ft. (46 m).

TECHNICAL DESCRIPTION



MAIN BOOM

Four section, full power, synchronized boom. Boom is constructed of high-yield steel. 5 sheave quick reeve boom tip with removable rope guards. Rope termination lugs on both sides of boom head. Auxiliary lifting sheave and manual angle indicator are included.

Fully extended boom length: 101.7 ft. (31 m).
 Fully retracted boom length: 32.2 ft. (10 m).
 Max. tip height, main boom: 111 ft. (33.8 m).

Boom angle range (min./max.) -3° / + 76°.
 Boom raising / lowering time 56 sec. / 63 sec.
 Boom extension / retraction time 100 sec. / 80 sec.

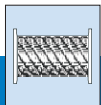

MAIN AND AUXILIARY WINCHES

Standard two speed main and auxiliary hoists, each with planetary reduction and spring applied multi-disk wet brake.

Each hoist features:
 Grooved drum lagging.
 Hoist drum cable followers.
 Max. permissible line pull: 15,432 lbs. (7000 kg).
 Winch speed: 0 - 492 fpm. (0 - 150 m/min).
 Power up / power down.
 Electronic drum rotation indicators.

Rope construction: 0.67 in. (17 mm) rotation resistant compacted strand.



CAMERAS

The crane comes equipped with two cameras, a winch camera for viewing hoist operation and a rear camera for viewing the rear of the crane. The monitor is located in the cab, and one can easily toggle between both camera views.

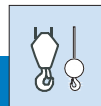





HOOK BLOCK AND HOOK BALL

35 ton, 4 sheave (steel), standard reeve hook block with odd part pin-off and safety latch.
 Hook block weight 727.5 lbs. (330 kg).
 6.1 ton top swivel hook ball with safety latch.
 Hook ball weight 265 lbs. (120 kg).

CRANE AND COMPONENT WEIGHTS

CRANE OPERATING WEIGHTS						
 Crane with ctwt.	Gross Vehicle Weight		Front Axle Load		Rear Axle Load	
	lb	kg	lb	kg	lb	kg
	70,547	32,000	33,135	15,030	37,412	16,970

DEDUCTIONS FOR LOAD HANDLING					
 Jib stowed aside boom  Auxiliary head	lb	kg		lb	kg
		726	330	 4 sheave 35 ton hook block	727.5
	158	72	 6.1 ton hook ball	265	120

TURNING RADIUS

	Imperial	Metric
Front Wheel (4x2) Steering	42 ft.	12.7 m
All Wheel (4x4) Steering Radius	37 ft.	11.25 m
Tail Swing	12 ft.	3.7 m

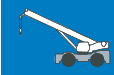

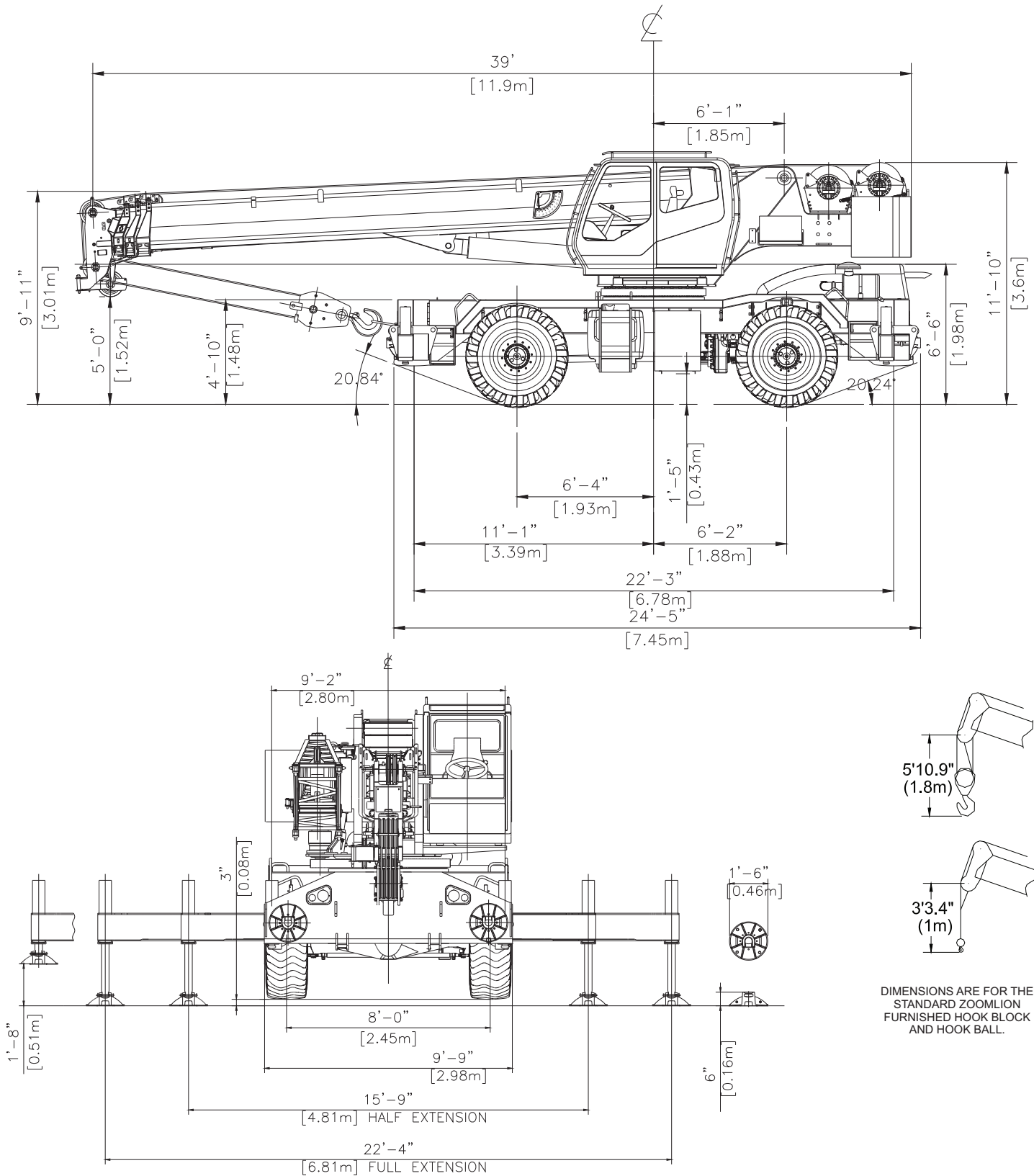

CRANE DIMENSIONS



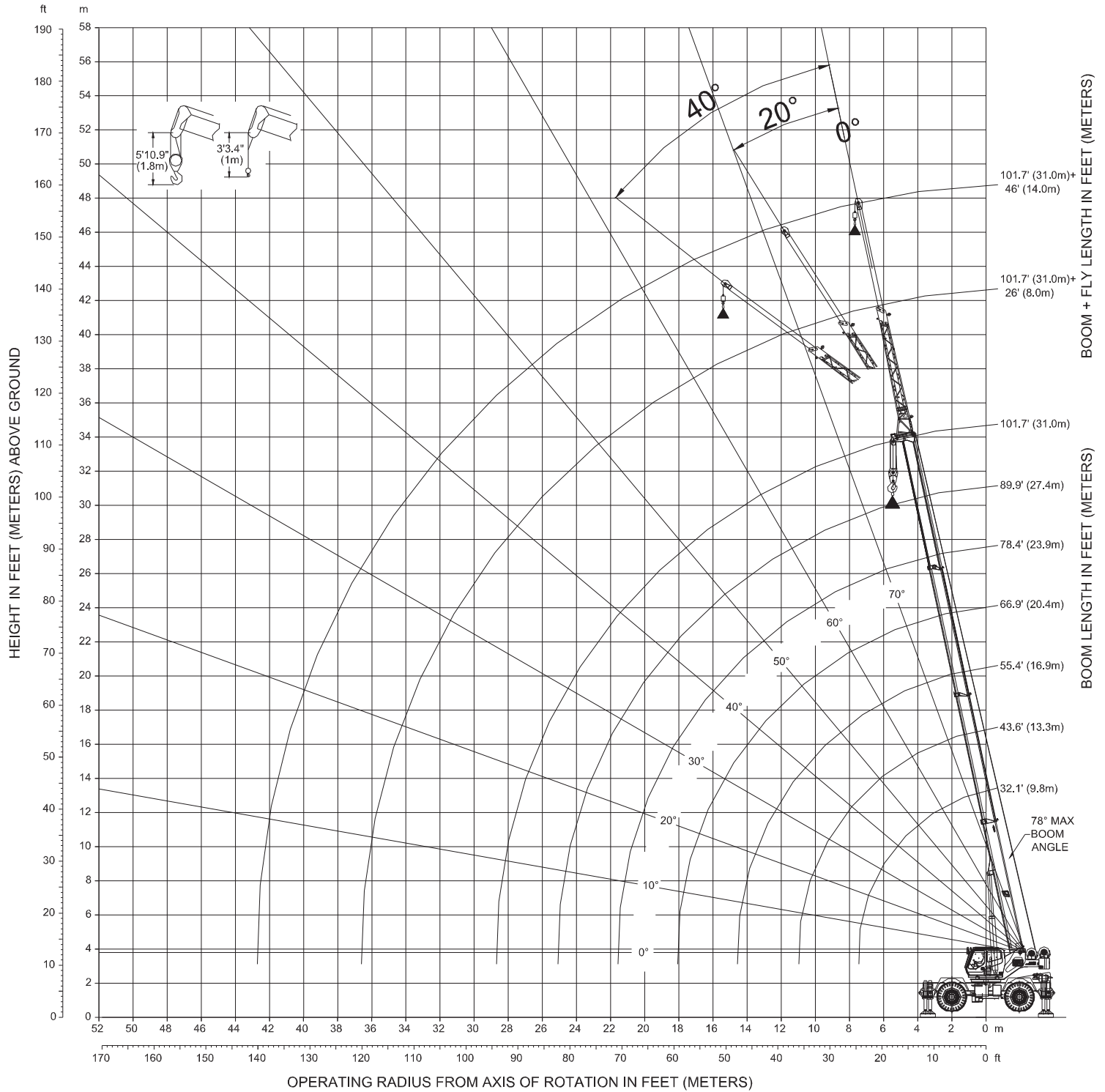

WORKING RANGE DIAGRAM



 FULLY EXTENDED OUTRIGGERS - MAIN BOOM CAPACITY 4,500 kg. cwt. ANSI B30.5 85% 360°								
BOOM LENGTH IN METERS - CAPACITY LISTED IN KILOGRAMS								
RADIUS	9.8	13.3	16.9	20.4	23.9	27.5	31.0	RADIUS
M								M
3.0	35000	20270						3.0
3.5	35000	20270						3.5
4.0	32950	20270	19650					4.0
4.5	29600	20270	19650					4.5
5.0	26800	20270	19650	18650				5.0
6.0	22400	20270	19650	17100	14100			6.0
7.0	19040	19230	19650	15740	13050	11350		7.0
8.0		15480	15680	14650	12200	10650	9450	8.0
9.0		12280	12460	12470	11450	10000	8950	9.0
10.0		10060	10210	10220	10340	9450	8500	10.0
11.0		8460	8570	8580	8680	8650	7740	11.0
12.0			7310	7320	7410	7380	7100	12.0
13.0			6330	6320	6410	6390	6440	13.0
14.0			5540	5520	5600	5580	5630	14.0
15.0			4930	4870	4940	4910	4960	15.0
16.0				4320	4380	4350	4400	16.0
17.0				3870	3900	3880	3920	17.0
18.0				3490	3500	3470	3510	18.0
19.0					3150	3120	3150	19.0
20.0					2850	2810	2840	20.0
21.0					2590	2540	2570	21.0
22.0					2390	2310	2320	22.0
23.0						2100	2100	23.0
24.0						1920	1910	24.0
25.0						1770	1740	25.0
26.0							1580	26.0
27.0							1440	27.0
28.0							1320	28.0
29.0							1230	29.0

LIFTING CAPACITY NOTES:

Rated lifting capacities shown do not exceed 85% of the tipping loads. The weight of the hook block, hook ball and any additional auxiliary lifting devices are not calculated into the rated lifting capacity and must be deducted prior to operation.

 MID POSITION OUTRIGGERS - MAIN BOOM CAPACITY								
4,500 kg. ctwt.		ANSI B30.5			85%		360°	
BOOM LENGTH IN METERS - CAPACITY LISTED IN KILOGRAMS								
RADIUS	9.8	13.3	16.9	20.4	23.9	27.5	31.0	RADIUS
M								M
3.0	35000	20270						3.0
3.5	33400	20270						3.5
4.0	29600	20270	20000					4.0
4.5	26500	20270	20000					4.5
5.0	21850	20270	20000	18650				5.0
6.0	15020	15350	15560	15560	14100			6.0
7.0	11180	11460	11640	11650	11780	11350		7.0
8.0		8970	9140	9140	9260	9220	9260	8.0
9.0		7240	7390	7400	7510	7470	7510	9.0
10.0		5980	6110	6120	6220	6190	6220	10.0
11.0		5040	5140	5140	5230	5200	5250	11.0
12.0			4370	4370	4460	4430	4480	12.0
13.0			3750	3750	3830	3810	3850	13.0
14.0			3260	3240	3310	3290	3340	14.0
15.0			2880	2820	2880	2860	2900	15.0
16.0				2460	2510	2490	2530	16.0
17.0				2170	2200	2180	2220	17.0
18.0				1930	1930	1910	1940	18.0
19.0					1700	1670	1700	19.0
20.0					1500	1460	1490	20.0
21.0					1330	1280	1300	21.0
22.0					1200	1120	1130	22.0

LIFTING CAPACITY NOTES:

Rated lifting capacities shown do not exceed 85% of the tipping loads. The weight of the hook block, hook ball and any additional auxiliary lifting devices are not calculated into the rated lifting capacity and must be deducted prior to operation.

 FULLY RETRACTED OUTRIGGERS - MAIN BOOM CAPACITY								
4,500 kg. ctwt.		ANSI B30.5			85%		360°	
BOOM LENGTH IN METERS - CAPACITY LISTED IN KILOGRAMS								
RADIUS	9.8	13.3	16.9	20.4	23.9	27.5	31.0	RADIUS
M								M
3.0	25310	20270						3.0
3.5	18610	18970						3.5
4.0	14490	14820	15010					4.0
4.5	11700	12000	12190					4.5
5.0	9690	9970	10150	10140				5.0
6.0	6990	7240	7410	7410	7530			6.0
7.0	5270	5500	5650	5650	5760	5720		7.0
8.0		4290	4430	4430	4540	4500	4540	8.0
9.0		3410	3540	3540	3640	3600	3640	9.0
10.0		2740	2850	2860	2950	2920	2950	10.0
11.0		2230	2320	2320	2400	2380	2420	11.0
12.0			1890	1890	1970	1940	1980	12.0
13.0			1540	1540	1610	1590	1630	13.0
14.0			1260	1240	1310	1290	1330	14.0
15.0			1060	1000	1060	1040	1080	15.0

 4,500 kg. ctwt.		ON TIRES BOOM CENTERED ANSI B30.5			75% OVER FRONT	
BOOM LENGTH IN METERS - CAPACITY LISTED IN KILOGRAMS						
RADIUS	9.8	13.4	16.9	20	RADIUS	
M						M
3.0	23400	20270				3.0
3.5	20800	20720				3.5
4.0	18650	18810	18890			4.0
4.5	16820	16990	17100			4.5
5.0	15620	15460	15600	15590		5.0
6.0	11240	11490	11660	11660		6.0
7.0	8550	8770	8920	8930		7.0
8.0		6950	7090	7100		8.0
9.0		5660	5780	5790		9.0
10.0		4690	4800	4810		10.0
11.0		3960	4050	4050		11.0
12.0			3440	3440		12.0
13.0			2950	2950		13.0
14.0			2560	2540		14.0
15.0			2260	2200		15.0
16.0				1920		16.0
17.0				1680		17.0
18.0				1490		18.0

	360° ON TIRES				
	4,500 kg. ctwt.	ANSI B30.5	85%	360°	
BOOM LENGTH IN METERS - CAPACITY LISTED IN KILOGRAMS					
RADIUS	9.8	13.4	16.9	20	RADIUS
M					M
3.0	14340	14560			3.0
3.5	12200	12430			3.5
4.0	10560	10760	10900		4.0
4.5	9180	9410	9540		4.5
5.0	7660	7920	8090	8080	5.0
6.0	5370	5610	5770	5760	6.0
7.0	3890	4110	4250	4250	7.0
8.0		3050	3190	3190	8.0
9.0		2280	2410	2410	9.0
10.0		1700	1810	1800	10.0
11.0		1250	1330	1330	11.0

JIB CAPACITY AT RADIUS ANSI B30.5							
30ft. (9m)						85%	
0° OFFSET		20° OFFSET		40° OFFSET			
Boom Angle (°)	Load Radius (m)	Capacity (kg)	Load Radius (m)	Capacity (kg)	Load Radius (m)	Capacity (kg)	Boom Angle (°)
76	8.1	3000	10.9	1800	13.1	1100	76
74	9.5	3000	12.2	1650	14.4	1050	74
72	10.8	3000	13.6	1550	15.6	990	72
70	12.2	3000	14.9	1450	16.8	940	70
68	13.5	2850	16.1	1400	18.0	940	68
66	14.8	2550	17.4	1300	19.2	900	66
64	16.1	2350	18.6	1250	20.4	900	64
62	17.4	2150	19.8	1200	21.5	850	62
60	18.7	1990	21.0	1150	22.6	850	60
58	20.0	1850	22.2	1100	23.7	800	58
56	21.1	1700	23.3	1050	24.8	800	56
54	22.2	1600	24.4	990	25.9	800	54
52	23.4	1500	25.5	940	27.0	750	52
50	24.5	1400	26.5	940	28.0	750	50
48	25.6	1290	27.5	900	29.0	750	48
46	26.6	1160	28.5	850	30.0	750	46
44	27.7	1040	29.4	850	31.0	700	44
42	28.6	940	30.3	800	31.9	700	42
40	29.6	850	31.1	800	32.9	700	40
38	30.6	770	31.9	730	33.8	700	38

 JIB CAPACITY AT RADIUS ANSI B30.5							
49ft. (15m)							85%
	0° OFFSET		20° OFFSET		40° OFFSET		
Boom Angle (°)	Load Radius (m)	Capacity (kg)	Load Radius (m)	Capacity (kg)	Load Radius (m)	Capacity (kg)	Boom Angle (°)
76	9.8	2400	14.8	940	18.8	550	76
74	11.4	2050	16.3	900	20.2	550	74
72	13.0	1850	17.9	800	21.6	490	72
70	14.5	1650	19.4	750	22.9	490	70
68	16.1	1450	20.8	700	24.2	450	68
66	17.6	1350	22.2	650	25.5	450	66
64	19.2	1200	23.6	650	26.8	400	64
62	20.7	1100	25.0	600	27.9	400	62
60	22.2	990	26.4	550	29.1	400	60
58	23.6	940	27.7	550	30.2	350	58
56	25.0	850	28.9	490	31.3	350	56
54	26.3	800	30.2	490	32.4	350	54
52	27.8	750	31.4	450	33.4	350	52
50	29.0	700	32.6	450	34.4	350	50
48	30.2	650	33.6	400	35.4	300	48
46	31.5	600	34.7	400	36.2	300	46
44	32.7	600	35.8	400	37.1	300	44
42	33.8	550	36.8	350	37.9	300	42
40	34.9	490	37.7	350	38.6	300	40
38	36.0	490	38.6	350	39.3	300	38

LOCATIONS



Global Equipment is the Exclusive Worldwide Distributor for Zoomlion Rough Terrain Cranes and all prices and availability will be negotiated with Global Equipment.



HEADQUARTERS

Global Machinery & Equipment, LLC
14800 Jersey Shore Drive,
Houston, TX 77047 USA
Toll Free: (866) 278-9780
Phone: +1 (713) 586-8808 | Fax: +1 (713) 586-8805
info@globalcranesales.com | www.globalcranesales.com

Uri Toudjarov

E-mail: uri@globalcranesales.com
Cell: +1 (602) 320-0762

Ed Gibson - North America

E-mail: egibson@globalcranesales.com
Direct: +1 (310) 749-0634

Due to constant improvement and engineering, we reserve the right to change the design, specifications, and equipment pricing without notification. Illustrations provided may or may not include all standard and optional equipment and accessories.