



ROUGH TERRAIN CRANE RT 780

DATASHEET - IMPERIAL



RT 780

Features:

- ▶ Rated capacity:
80 ton @ 10 ft working radius
- ▶ Maximum boom length:
126 ft
- ▶ Maximum tip height:
190 ft

WORKS FOR YOU.™

Key

| | |
|-------|---|
| | 3 |
|-------|---|

Dimensions













































| | |
|------------------------|---|
| Crane dimensions | 4 |
| Crane weights | 5 |

Load charts

| | |
|--|----|
| Range Diagram – Main Boom – Outriggers fully extended (100%) | 6 |
| Load Chart – Main Boom – Outriggers fully extended (100%) | 7 |
| Range Diagram – Main Boom – Outriggers fully retracted (0%) | 8 |
| Load Chart – Main Boom – Outriggers fully retracted (0%) | 9 |
| Range Diagram – Main Boom – 33 ft offsettable jib | 10 |
| Load Chart – Main Boom – 33 ft offsettable jib | 11 |
| Range Diagram – Main Boom – 57 ft offsettable jib | 12 |
| Load Chart – Main Boom – 57 ft offsettable jib | 13 |
| Range Diagram – Main Boom – On tires | 14 |
| Load Chart – Main Boom – On tires | 15 |

Technical description

| | |
|--|--------|
| Boom | 16 |
| Hoist, rope and hook | 16, 17 |
| Superstructure | 17 |
| Cab, controls, operator aids and load limiter / load indicator | 17, 18 |
| Carrier, engine, drive-line and hydraulic system | 18 |
| Vehicle performance | 19 |
| Tires | 19 |

| | | | |
|---|--|---|---|
|  | Counterweight |  | General performance |
|  | Main boom |  | Telescoping mode |
|  | Boom length |  | Boom luffing angle |
|  | Tip height |  | Working radius |
|  | Boom with extension |  | Max. boom length with extension |
|  | Main boom with aux head |  | Distance from the hook to the head sheave pin |
|  | Slewing / Allowable slewing range |  | Slewing locked / Slewing locked at specified position |
|  | Slewing brake |  | Slewing gears |
|  | Outriggers / Lifting on outriggers (100/50/0% extended) |  | Lifting on wheels / Pick & Carry |
|  | Main hoist |  | Auxiliary hoist |
|  | Hoist speed |  | Rope length |
|  | Rope - Standard / Optional |  | Max. line pull |
|  | Rope diameter |  | Tire |
|  | Hook block |  | Controls |
|  | Cab |  | Engine |
|  | Operator aids / Load limiter / Load indicator |  | Steering |
|  | Mechanical transmission |  | Speed |
|  | HYDR Hydraulics |  | Heating / Air conditioning |
|  | Working temperature |  | Gradeability |
|  | Lights |  | Gross vehicle weight |
|  | Crane / Crane in standard configuration |  | Weight on front axle |
|  | Crane without counterweight |  | Weight on rear axle |

CRANE DIMENSIONS

RT 780

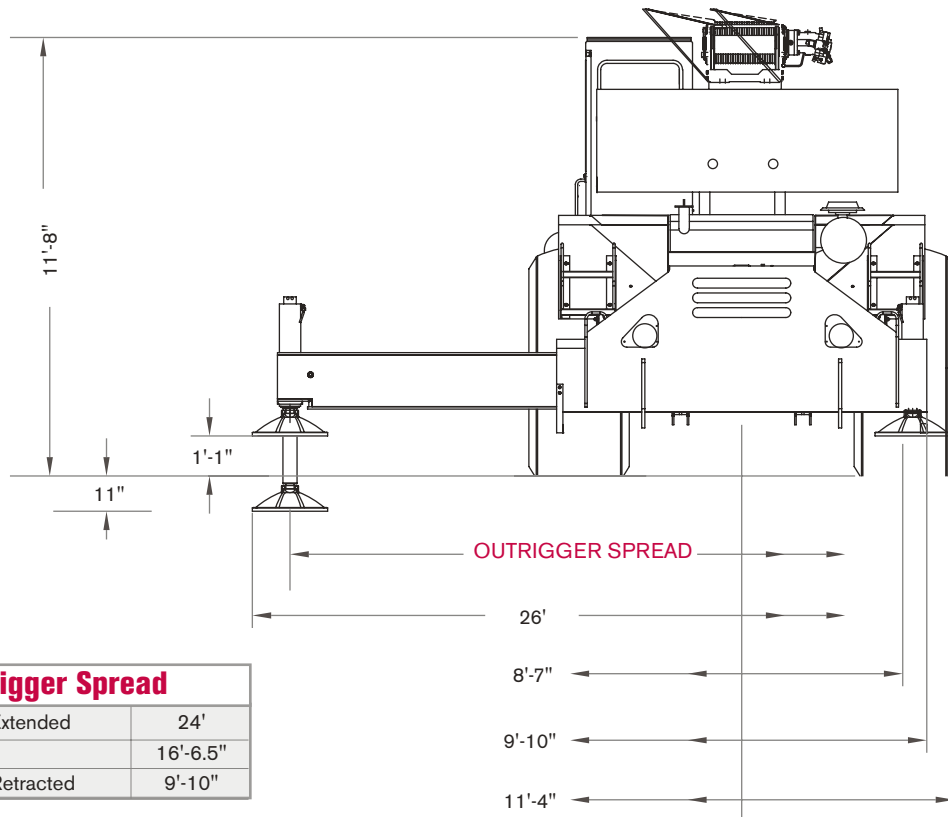
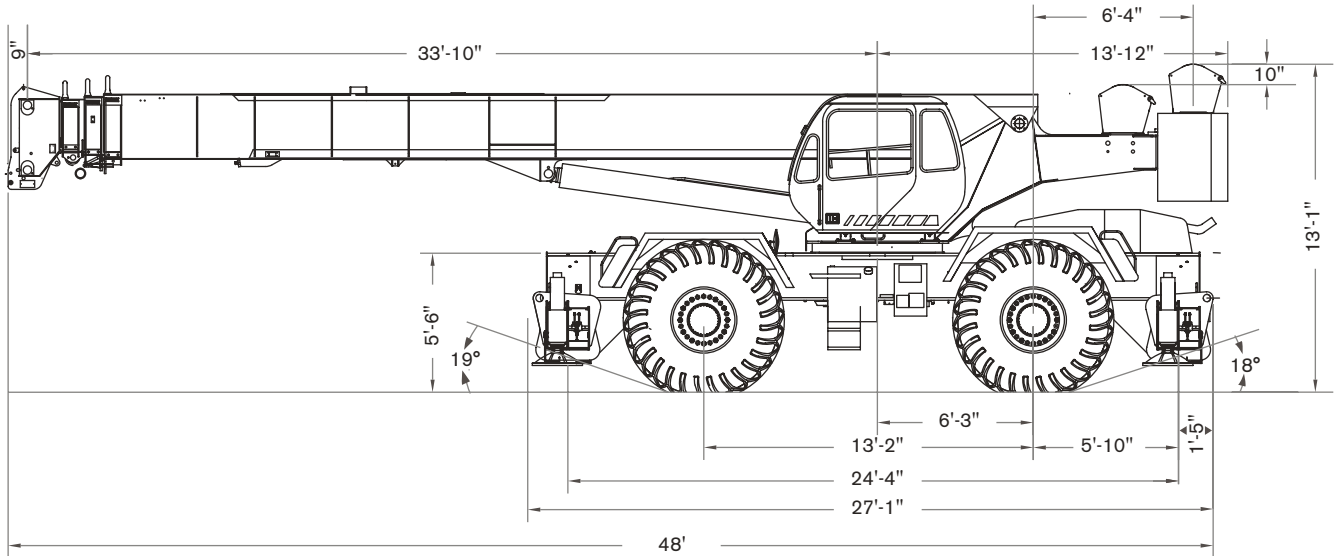





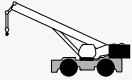

| Outrigger Spread | |
|-------------------------|----------|
| Fully Extended | 24' |
| Half | 16'-6.5" |
| Fully Retracted | 9'-10" |

CRANE WEIGHTS

RT 780

Approximate Weights

| | | ↓ GVW | ↑ | ↑ |
|--|------------------------------------|------------|------------|------------|
|  | STD | 91,216 lb | 47,047 lb | 44,169 lb |
| Add / Subtract for main optional equipment | | | | |
|  | 33 ft to 57 ft swing on jib stowed | + 2,170 lb | + 3,992 lb | - 1,822 lb |
|  | Auxiliary boom head | + 125 lb | + 406 lb | - 281 lb |
|  | Auxiliary hoist* | + 134 lb | - 35 lb | + 159 lb |
|  | 5 sheaves, 75T | + 1,608 lb | + 3,447 lb | - 1,839 lb |
|  | 5 sheaves, 60T | + 1,204 lb | + 2,581 lb | - 1,377 lb |

NOTE: Values are subject to 2% variation

* Weight includes rope

RANGE DIAGRAM - MAIN BOOM

RT 780

Outriggers Fully Extended (100%)

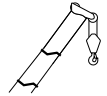

 with hook block:
6 ft 9 in

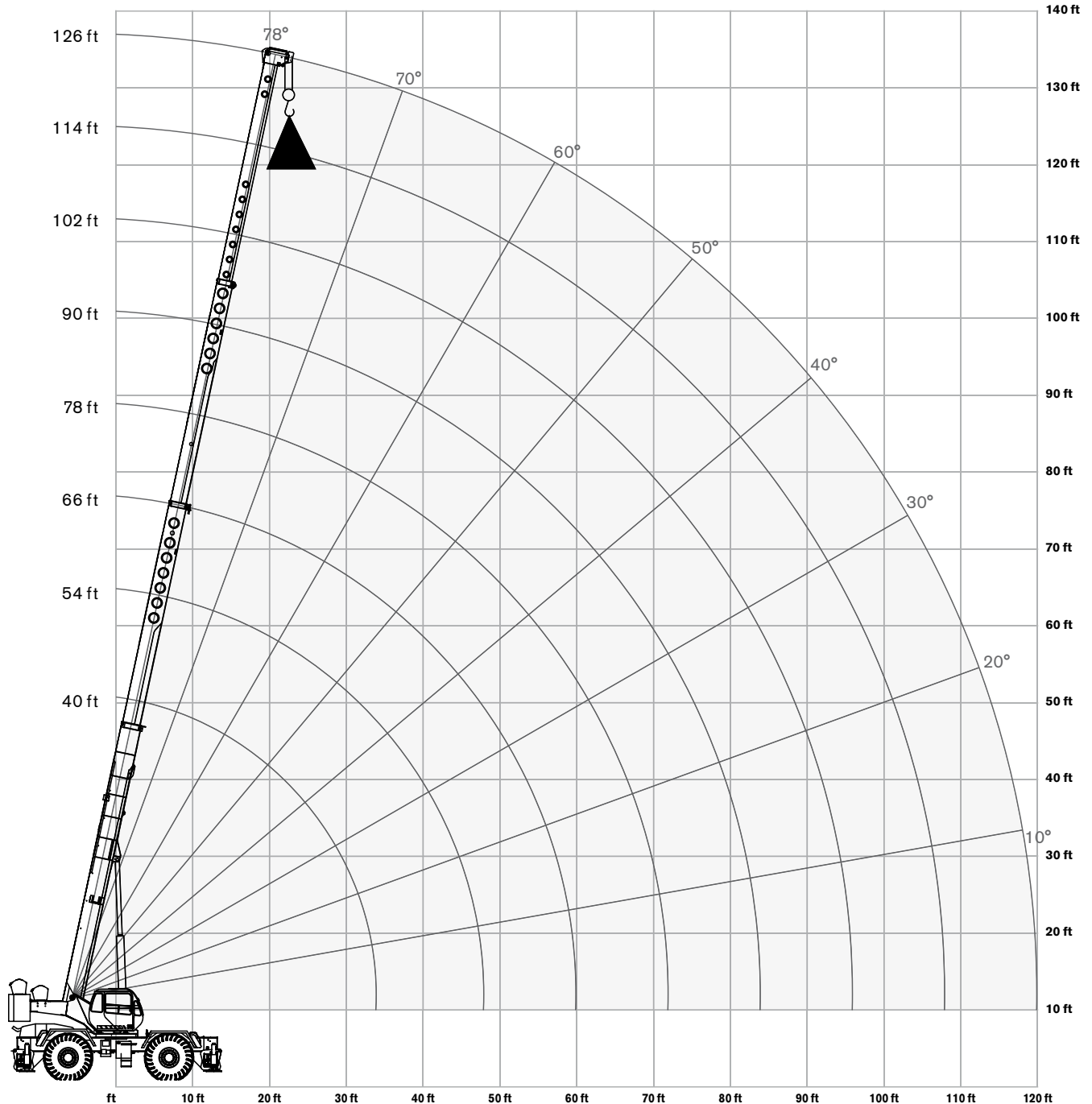



LOAD CHART- MAIN BOOM

RT 780

Outriggers Fully Extended (100%)

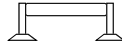
 15,200 lbs counterweight

 Outriggers extended 24 ft (100%)

 360 degree rotation

Standard ASME B30.5

|  | Boom Length | | | | | | | |  |
|---|-------------|---------|--------|--------|--------|--------|--------|--------|---|
| | 40 ft | 54 ft | 66 ft | 78 ft | 90 ft | 102 ft | 114 ft | 126 ft | |
| ft | lb | lb | lb | lb | lb | lb | lb | lb | ft |
| 10 | 160,000 | 102,500 | | | | | | | 10 |
| 12 | 125,600 | 102,500 | | | | | | | 12 |
| 15 | 108,800 | 100,500 | 80,600 | | | | | | 15 |
| 20 | 84,700 | 85,300 | 71,900 | 62,200 | 56,200 | | | | 20 |
| 25 | 65,600 | 66,700 | 64,800 | 55,700 | 48,000 | 41,900 | | | 25 |
| 30 | 49,200 | 50,500 | 51,000 | 49,700 | 41,700 | 36,400 | 31,500 | | 30 |
| 35 | | 37,700 | 38,200 | 38,500 | 36,600 | 32,100 | 29,500 | 24,700 | 35 |
| 40 | | 29,400 | 29,900 | 30,200 | 30,400 | 28,600 | 26,200 | 24,600 | 40 |
| 45 | | 23,500 | 24,100 | 24,400 | 24,600 | 24,700 | 23,500 | 22,100 | 45 |
| 50 | | | 19,800 | 20,200 | 20,300 | 20,500 | 20,600 | 20,000 | 50 |
| 55 | | | 16,400 | 16,900 | 17,100 | 17,200 | 17,300 | 17,400 | 55 |
| 60 | | | | 14,200 | 14,500 | 14,600 | 14,700 | 14,800 | 60 |
| 65 | | | | 12,100 | 12,300 | 12,500 | 12,600 | 12,700 | 65 |
| 70 | | | | 10,300 | | 10,800 | 10,900 | 10,900 | 70 |
| 75 | | | | | | 9,200 | 9,400 | 9,400 | 75 |
| 80 | | | | | | 7,900 | 8,100 | 8,200 | 80 |
| 85 | | | | | | 6,800 | 6,900 | 7,100 | 85 |
| 90 | | | | | | 5,800 | 6,000 | 6,100 | 90 |
| 95 | | | | | | 4,900 | 5,100 | 5,200 | 95 |
| 100 | | | | | | | 4,300 | 4,400 | 100 |
| 105 | | | | | | | 3,600 | 3,700 | 105 |
| 110 | | | | | | | | 3,100 | 110 |
| 115 | | | | | | | | 2,500 | 115 |

Notes to lifting capacity

Lifting capacities do not exceed 85% of tipping load. Weight of hook blocks and slings is part of the load, and is to be deducted from the capacity ratings. Consult operation manual for further details.

Note: Data published herein is intended as a guide only and shall not be construed to warrant applicability for lifting purposes. Crane operation is subject to the computer charts and operation manual both supplied with the crane.

RANGE DIAGRAM - MAIN BOOM

RT 780

Outriggers Fully Retracted (0%)

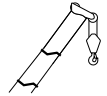

 with hook block:
6 ft 9 in

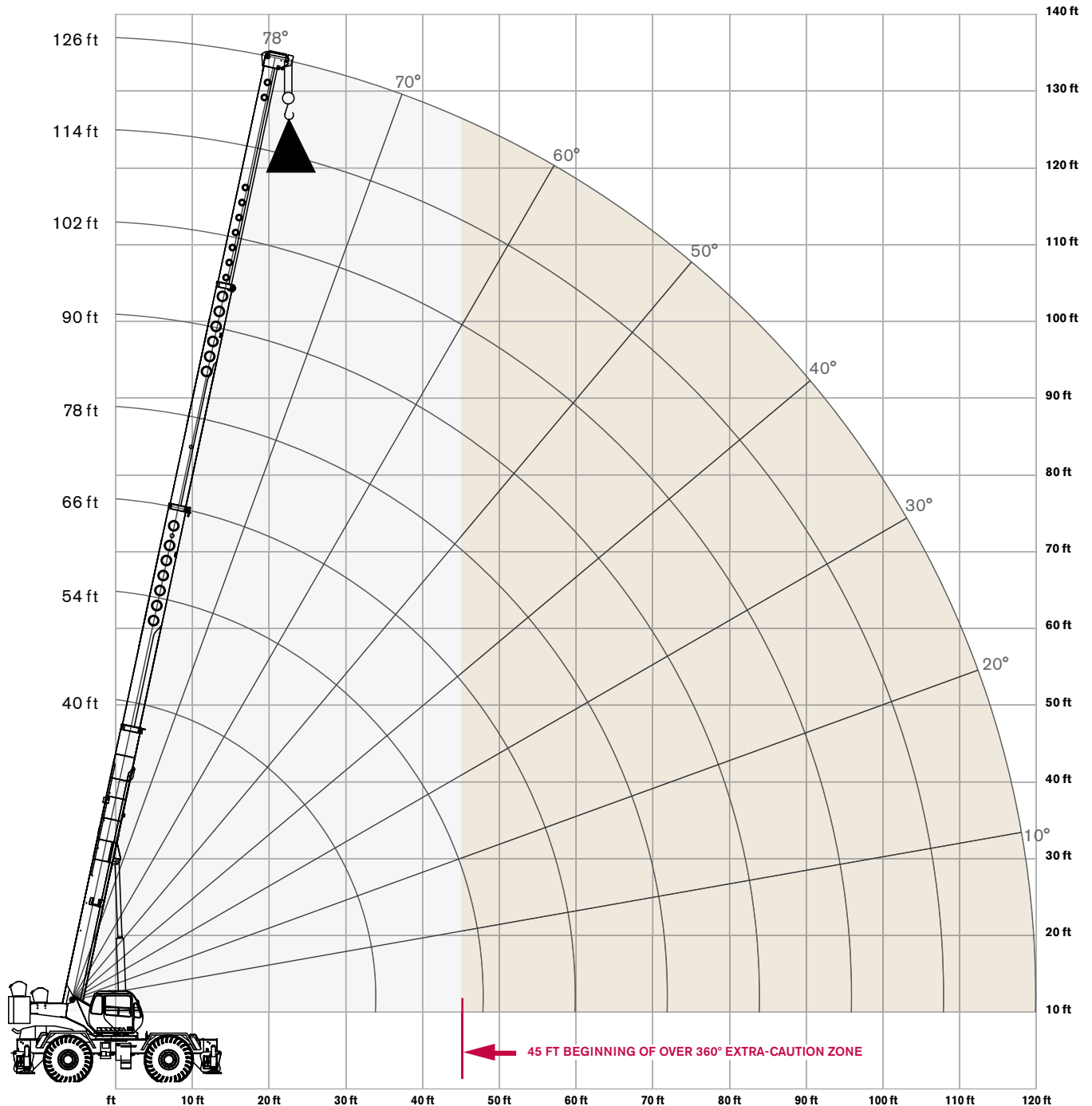



LOAD CHART- MAIN BOOM

RT 780

Outriggers Fully Retracted (0%)

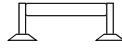
 15,200 lbs counterweight

 Outriggers retracted 9 ft 10 in (0%)

 360 degree rotation

Standard ASME B30.5

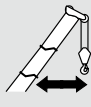
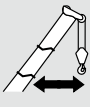
|  | Boom Length | | | | | | | |  |
|---|-------------|--------|--------|--------|--------|--------|--------|--------|---|
| | 40 ft | 54 ft | 66 ft | 78 ft | 90 ft | 102 ft | 114 ft | 126 ft | |
| ft | lb | lb | lb | lb | lb | lb | lb | lb | ft |
| 10 | 84,500 | 85,600 | | | | | | | 10 |
| 12 | 59,300 | 60,300 | | | | | | | 12 |
| 15 | 39,300 | 40,400 | 40,800 | | | | | | 15 |
| 20 | 23,200 | 24,300 | 24,800 | 25,000 | 25,200 | | | | 20 |
| 25 | 14,900 | 16,000 | 16,500 | 16,800 | 17,000 | 17,000 | | | 25 |
| 30 | 9,800 | 10,900 | 11,400 | 11,800 | 12,000 | 12,000 | 12,100 | | 30 |
| 35 | | 7,500 | 8,000 | 8,400 | 8,600 | 8,600 | 8,800 | 8,900 | 35 |
| 40 | | 5,000 | 5,600 | 5,900 | 6,100 | 6,100 | 6,300 | 6,500 | 40 |
| 45 | | 3,200 | 3,700 | 4,000 | 4,300 | 4,300 | 4,500 | 4,700 | 45 |
| 50 | | | | | | | 3,000 | 3,300 | 50 |

Notes to lifting capacity

Lifting capacities do not exceed 85% of tipping load. Weight of hook blocks and slings is part of the load, and is to be deducted from the capacity ratings. Consult operation manual for further details.

Note: Data published herein is intended as a guide only and shall not be construed to warrant applicability for lifting purposes. Crane operation is subject to the computer charts and operation manual both supplied with the crane.

RANGE DIAGRAM - MAIN BOOM

RT 780

With Jib, 33 ft offset



with hook block:
6 ft 9 in

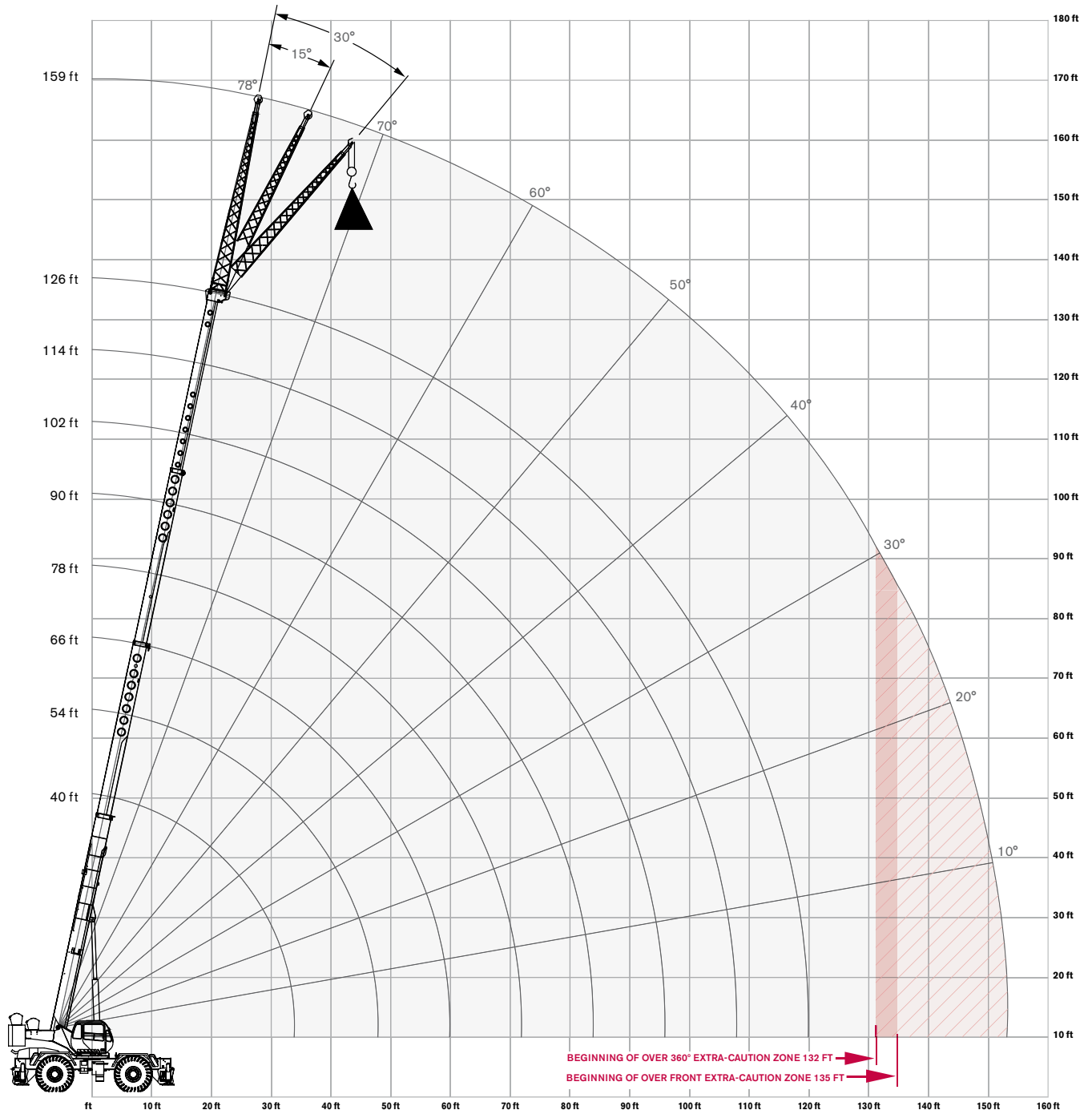



LOAD CHART- MAIN BOOM

RT 780



With Jib, 33 ft offset

 15,200 lbs counterweight

 Outriggers extended 24 ft (100%)

 360 degree rotation

Standard ASME B30.5

| 33 ft Offsettable Jib | | | | | |
|---|--------|---|-------|---|-------|
| 0° Offset | | 15° Offset | | 30° Offset | |
|  Radius (ft) | lbs |  Radius (ft) | lbs |  Radius (ft) | lbs |
| 41 | 12,500 | 50 | 8,500 | 57 | 6,400 |
| 47 | 12,000 | 56 | 8,100 | 62 | 6,200 |
| 52 | 11,500 | 61 | 7,800 | 67 | 6,100 |
| 58 | 10,900 | 67 | 7,500 | 72 | 5,900 |
| 66 | 9,900 | 74 | 7,100 | 79 | 5,900 |
| 74 | 9,200 | 81 | 6,700 | 86 | 5,600 |
| 81 | 8,600 | 88 | 6,400 | 93 | 5,400 |
| 88 | 7,300 | 95 | 6,200 | 99 | 5,300 |
| 97 | 5,700 | 103 | 5,200 | 107 | 5,200 |
| 105 | 4,500 | 111 | 4,200 | 114 | 4,300 |
| 113 | 3,600 | 117 | 3,400 | 120 | 3,500 |
| 120 | 2,900 | 124 | 2,700 | 126 | 2,800 |
| 127 | 2,200 | 131 | 2,000 | 132 | 1,900 |
| 135 | 1,600 | 138 | 1,400 | 138 | 1,100 |

Notes to lifting capacity

Lifting capacities do not exceed 85% of tipping load. Weight of hook blocks and slings is part of the load, and is to be deducted from the capacity ratings. Consult operation manual for further details.

Note: Data published herein is intended as a guide only and shall not be construed to warrant applicability for lifting purposes. Crane operation is subject to the computer charts and operation manual both supplied with the crane.

RANGE DIAGRAM - MAIN BOOM

RT 780

With Jib, 57 ft offset

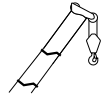

with hook block:
6 ft 9 in

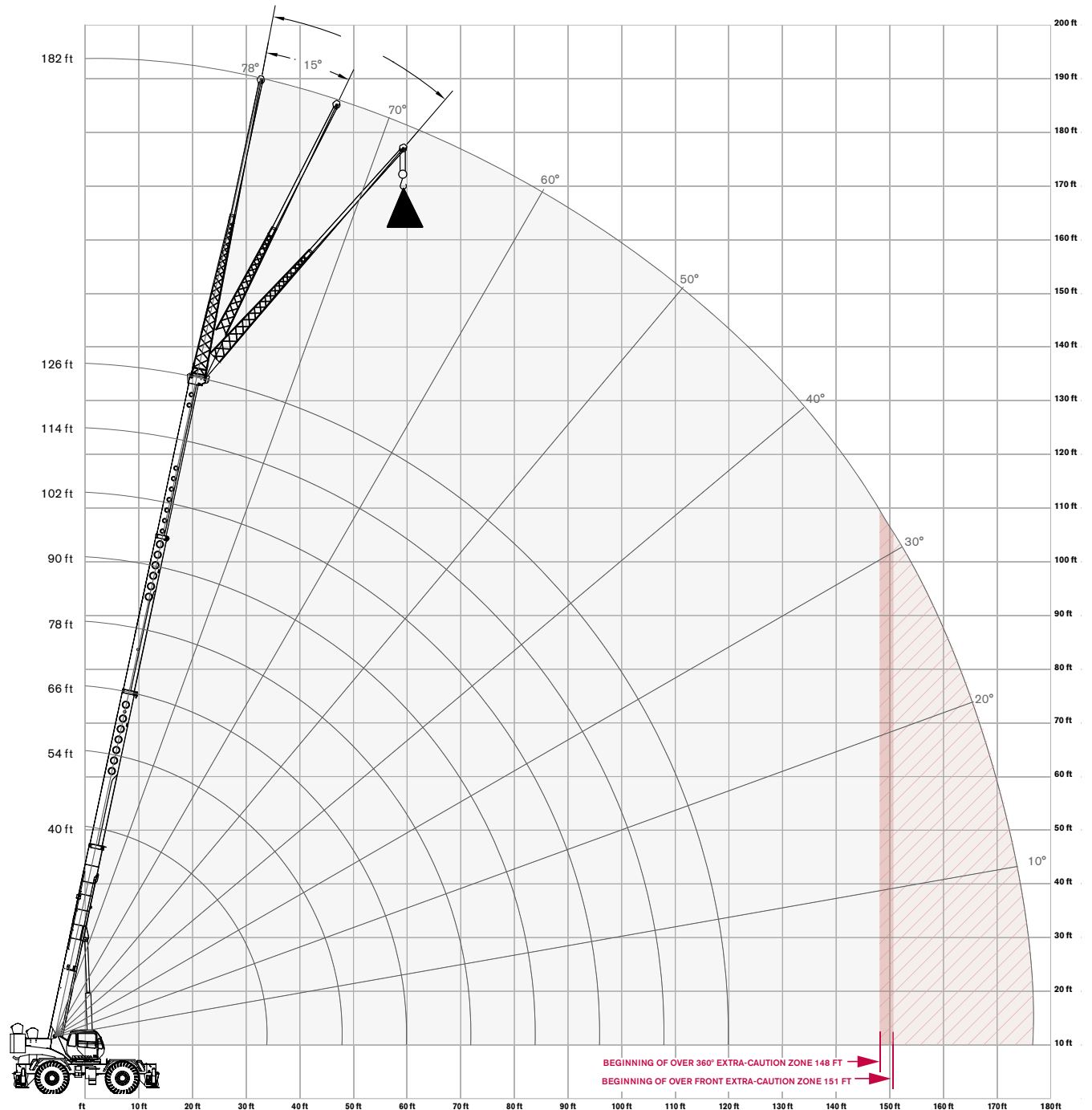



LOAD CHART- MAIN BOOM

RT 780

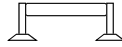

With Jib, 57 ft offset

 15,200 lbs counterweight

 Outriggers extended 24 ft (100%)

 360 degree rotation

Standard ASME B30.5

| 57 ft Offsettable Jib | | | | | |
|---|-------|---|-------|---|-------|
| 0° Offset | | 15° Offset | | 30° Offset | |
|  Radius (ft) | lbs |  Radius (ft) | lbs |  Radius (ft) | lbs |
| 48 | 6,500 | 66 | 4,500 | 75 | 3,300 |
| 56 | 6,400 | 72 | 4,300 | 81 | 3,200 |
| 63 | 6,200 | 77 | 4,100 | 87 | 3,100 |
| 70 | 6,000 | 83 | 3,900 | 92 | 3,000 |
| 80 | 5,400 | 91 | 3,700 | 100 | 2,900 |
| 90 | 4,900 | 99 | 3,500 | 108 | 2,800 |
| 98 | 4,500 | 106 | 3,300 | 115 | 2,700 |
| 106 | 4,200 | 114 | 3,100 | 121 | 2,600 |
| 116 | 3,800 | 123 | 2,900 | 129 | 2,500 |
| 125 | 3,500 | 132 | 2,800 | 137 | 2,500 |
| 133 | 2,800 | 140 | 2,600 | 143 | 2,400 |
| 140 | 2,200 | 147 | 2,100 | 149 | 2,000 |
| 148 | 1,600 | 154 | 1,500 | 155 | 1,500 |
| 157 | 1,000 | 161 | 1,000 | 162 | 1,000 |

Notes to lifting capacity

Lifting capacities do not exceed 85% of tipping load. Weight of hook blocks and slings is part of the load, and is to be deducted from the capacity ratings. Consult operation manual for further details.

Note: Data published herein is intended as a guide only and shall not be construed to warrant applicability for lifting purposes. Crane operation is subject to the computer charts and operation manual both supplied with the crane.

RANGE DIAGRAM - MAIN BOOM

RT 780

On Tires

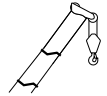

 with hook block:
6 ft 9 in

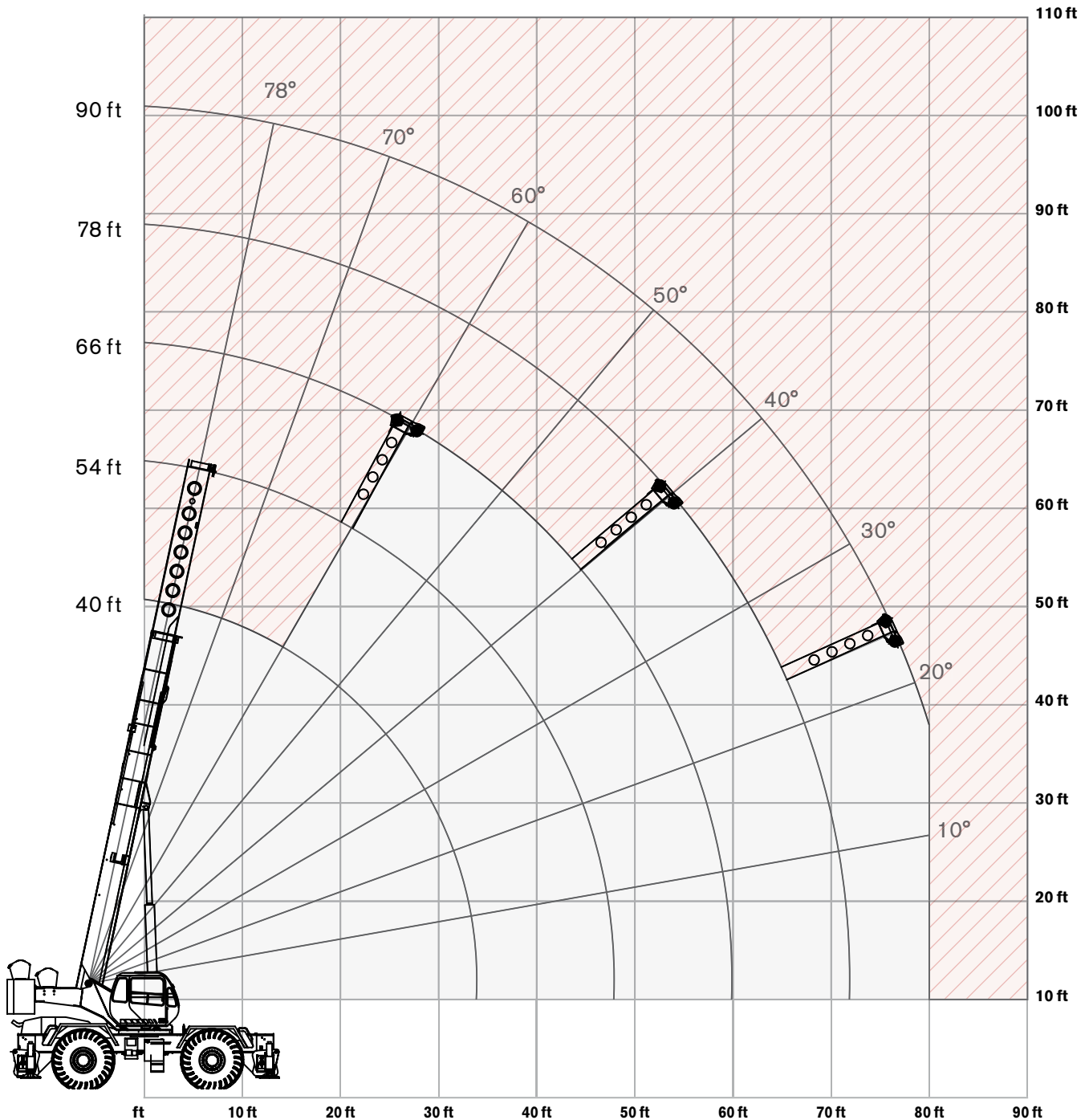



LOAD CHART- MAIN BOOM

RT 780

On Tires

 15,200 lbs counterweight

 360 degree rotation

 On tires
29.5 X 25-28PR

Standard ASME
B30.5







| Boom | | Travel Speed Boom straight over front | | |
|--------|--------|--|--------|---------|
| Radius | Length | 0 mph | Creep | 2.5 mph |
| ft | ft | lb | lb | lb |
| 10 | 40 | 82,700 | 68,700 | 51,800 |
| 12 | 40 | 69,800 | 60,400 | 45,300 |
| 15 | 40 | 54,200 | 50,700 | 37,600 |
| 20 | 40 | 36,000 | 36,000 | 28,700 |
| 25 | 54 | 24,900 | 24,700 | 22,500 |
| 30 | 54 | 18,200 | 18,200 | 17,800 |
| 35 | 54 | 14,200 | 14,200 | 14,200 |
| 40 | 66 | 11,600 | 11,600 | 11,100 |
| 45 | 66 | 9,600 | 9,600 | 9,000 |
| 50 | 66 | 7,900 | 7,900 | 7,900 |
| 55 | 78 | 6,300 | 6,300 | 6,300 |
| 60 | 78 | 4,900 | 4,900 | 4,900 |
| 65 | 78 | 3,300 | 3,300 | 3,300 |
| 70 | 90 | 3,100 | 3,100 | 3,100 |
| 75 | 90 | 2,700 | 2,700 | 2,700 |
| 80 | 90 | 2,200 | 2,200 | 2,200 |

Notes to lifting capacity







Lifting capacities do not exceed 75% of tipping load. Weight of hook blocks and slings is part of the load, and is to be deducted from the capacity ratings. Consult operation manual for further details.







Note: Data published herein is intended as a guide only and shall not be construed to warrant applicability for lifting purposes. Crane operation is subject to the computer charts and operation manual both supplied with the crane.

Boom



| Standard configuration: | | |
|--|---|---------------------------------------|
|  | 4 sections hydraulic actuated boom | |
|  | Full power mechanically synchronized | |
|  | Min. / Max. | 40 ft / 126 ft |
|  | Boom elevation angle range (min. / max.) | -4° / 78° |
| Optional configuration: | | |
|  | Single sheave | |
|  | One section, side stowable, with pull out insert Angular offsets | 33 ft / 57 ft 0, 15 and 30 degrees |
|  | Jib with pull out extended | 190 ft |

Hoist, Rope and Hook



| Standard configuration: | | |
|---|--|--|
|  | Grooved drum Storage capacity | 561 ft |
|  | Two speed ratios Without load in 5th layer (low range / high range) Without load in 1st layer (low range / high range) | 275 ft/min / 489 ft/min 191 ft/min / 341 ft/min |
|  | 6 x 19 IWRC XIPS, right regular lay, preformed | |
|  | | 3/4 in |
|  | | 600 ft |
|  | Max. line pull; 1st layer low-range Max. line pull permissible | 18,450 lb 13,800 lb |

| Optional configuration: | | |
|---|--|--------------------------|
|  | 5 sheaves 5 sheaves | 60 ton 80 ton |
|  | Grooved drum Storage capacity | 591 ft |
|  | Without load in 5th layer (maximum) | 489 ft/min |
|  | Rotation resistant compacted strand 34X7 | |
|  | | 3/4 in |
|  | | 600 ft |
|  | Minimum breaking strength Permissible line pull | 69,000 lbs 13,800 lbs |

Superstructure

| Standard configuration: | | |
|---|--|-----------------|
|  | Non stop Maximum rotation speed without load | 360° 2.2 rpm |
|  | Hydraulic motor Planetary reducer | |
|  | Manually actuated by foot pedal 360° house lock | |

Cab, Controls, Operator aids and Load limiter / Load indicator

| Standard configuration: | | |
|---|--|--|
|  | Sliding door Hinged, tinted all glass skylight Six way adjustable seat | |
|  | Armrest mounted dual axis electro-proportional joysticks Steering wheel column with gear selector on the left and directional light selector on the right Dashboard mounted switches for outrigger operation | |
|  | Graphic interface for load indicator | |

Optional configuration:



Hydraulic powered air conditioner
 Hydraulic powered heater
 Work lights
 Rotating beacon

Carrier, Engine, Drive-line and Hydraulic system

Standard configuration:



Hydraulic, independent extension:
 Diameter of outrigger pads
 Area of outrigger pads

24 in
 452 in²



Cummins QSB6.7 6 cylinders
 Rated power
 Maximum gross torque
 Intake: turbocharger with intercooler
 Fuel type
 Diesel
 Fuel tank capacity

275 hp @ 2500 rpm
 750 ft-lb @ 1,500 rpm

80 gallons



6 x 6 powershift transmission with torque converter
 Selectable 4WD (Four-Wheel Drive)
 Rigid mounted front axle
 Oscillating rear axle
 Differential lock on front and rear axles
 Rear axle oscillation lock - manual or automatic actuation
 Air-over-hydraulic disc brakes
 Front axle parking brake
 Hydraulic oil cooler



Hydraulic power steering
 Front wheel steering
 Four wheel steering concentric
 Four wheel steering crab



Hydraulic Pumps:

Tandem pumps:

Boom lift / Telescope
 Power steering / Outriggers and swing

57.8 gal/min @ 4,500 psi
 42.1 gal/min @ 4,500 psi

Single pump:



Main and auxiliary hoist pump

52.7 gal/min @ 4,500 psi

Hydraulic oil reservoir capacity
 Hydraulic oil suction filter
 Hydraulic oil return filter

178 gallons
 250 microns
 5 microns

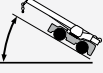
Vehicle performance

| Standard configuration: | | |
|---|--|-------------|
|  | Max. in 1 st gear Max. in 6 th gear | 98.9% 3% |
|  | Max. (6 th gear) | 25 mph |

Tires

| Standard configuration: | | |
|---|----------------------------------|----------------|
|  | Wide tread - Earth mover pattern | 29.5 X 25-28PR |

www.terexcranes.com

Effective Date: September 2010. Product specifications and prices are subject to change without notice or obligation. The photographs and/or drawings in this document are for illustrative purposes only. Refer to the appropriate Operator's Manual for instructions on the proper use of this equipment. Failure to follow the appropriate Operator's Manual when using our equipment or to otherwise act irresponsibly may result in serious injury or death. The only warranty applicable to our equipment is the standard written warranty applicable to the particular product and sale and Terex makes no other warranty, express or implied. Products and services listed may be trademarks, service marks or trade-names of Terex Corporation and/or its subsidiaries in the USA and other countries. All rights are reserved. Terex® is a registered trademark of Terex Corporation in the USA and many other countries. Copyright 2010 Terex Corporation..

Terex Cranes, Global Marketing, Dinglerstraße 24, 66482 Zweibrücken, Germany
Tel. +49 (0) 6332 830, Email: info.cranes@terex.com, www.terexcranes.com

Brochure Reference: TC-DS-I-E-RT 780-09/10



WORKS FOR YOU.™