



**KOEHRING CRANES
& EXCAVATORS**

**AMCA
INTERNATIONAL**

LORAIN[®] LRT 230

rough terrain crane
23-ton(20.9 mt) capacity

specifications





**KOEHRING CRANES
& EXCAVATORS**

**AMCA
INTERNATIONAL**

LORAIN[®] LRT 230

General Dimensions

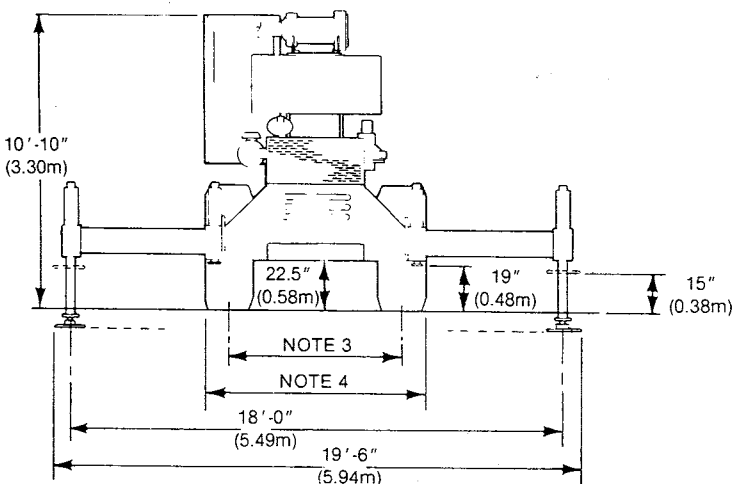
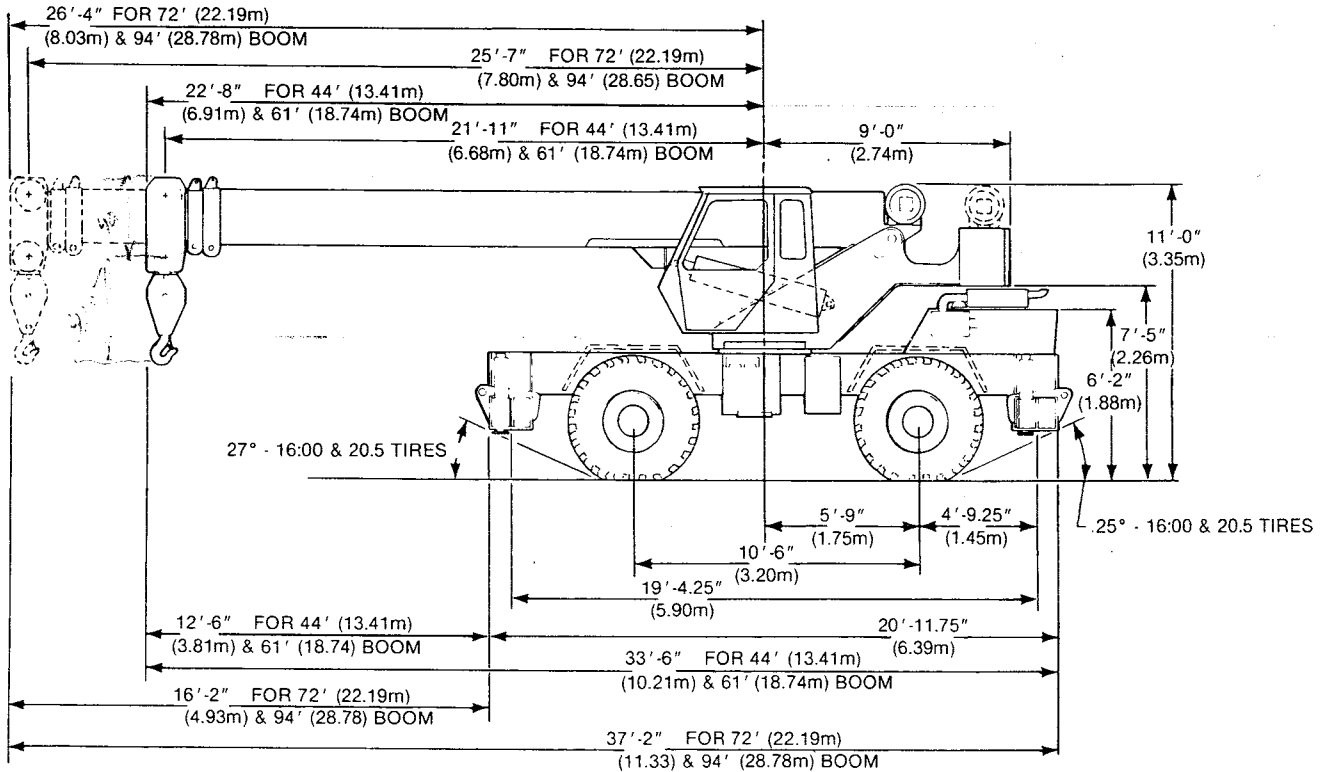

NOTES

1. Dimensions given assume the boom is fully retracted in travel position and 16:00 x 25 tires.
2. Minimum ground clearance under transmission and axles: 18" (0.46m).
3. Track width:
6'-6.5" (1.99m) 16:00 x 25 tires
6'-10.5" (2.10m) 20.5 x 25 tires
4. Width of carrier:
8'-0" (2.44m) 16:00 x 25 tires
8'-8" (2.64m) 20.5 x 25 tires

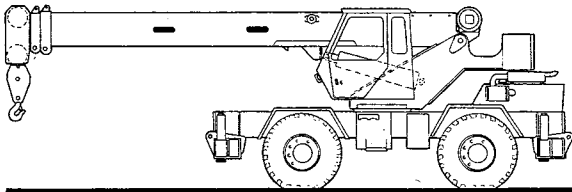

STANDARD BOOM EQUIPMENT

BOOM

30 - 72 ft. (9.23 - 22.19 m) three section full power, self-proportioning boom. Automatically maintains ideal strength-to-length ratio since telescoping sections extend and retract simultaneously with single lever control. Adjustable rollers for top and intermediate sections provide for easier telescoping, less maintenance and less wear. Single boom hoist cylinder. All cylinders equipped with integral hold valves. Boom elevation -5° to 76° .

BOOM HEAD

Four metallic sheaves, 12.125 in. (308 mm) pitch diameter, and two idler sheaves mounted on heavy duty, anti-friction bearings. Quick reeving boom head eliminates need to remove wedge and socket from rope which means fast, easy line part changes.

OPTIONAL BOOM EQUIPMENT

MAIN BOOMS

60652 26.5 - 44 ft. (8.08 - 13.41 m) two section full power boom, adjustable rollers, single boom hoist cylinder, integral hold valves, and standard quick-reeving boom head. Boom elevation is -5° to 76° .

60653 26.5 - 61 ft. (8.08 - 18.74 m) three section, full power, self-proportioning boom. Automatically maintains correct strength-to-length ratio since telescoping sections extend and retract simultaneously with single lever control. Top and intermediate sections travel on adjustable friction-reducing rollers. Has quick-reeving boom head. Boom elevation is -5° to 76° .

60651 30 - 94 ft. (9.23 - 28.78 m) four section boom, three sections full power, self-proportioning to 72' (22.19 m). Fourth section is power pinned pull out section. Single lever control of full power telescoping sections. Top and intermediate sections travel on adjustable friction-reducing rollers. Has quick-reeving boom head. Boom elevation is -5° to 76° .

JIBS

708A2994 15 - 20 ft. (4.57 - 6.10 m) A-frame jib, pendants, and single metallic sheave with 12.125 in. (308 mm) pitch diameter, mounted on anti-friction bearing. Jib swings under and is stowed beneath the boom base section. The 15 ft. (4.57 m) jib is extendible to 20 ft. (6.10 m) by means of a 5 ft. (1.52 m) pull-out tip section. Can be offset 24° . Installs to main boom only.

708A2694 25 ft. (7.62 m) side stow swing-on one-piece lattice type jib. One metallic sheave with 12.125 (308 mm) pitch diameter, mounted on anti-friction bearing. Installs to main boom only.

708A2695 25 - 42 ft. (7.62 - 12.80 m) side stow swing-on lattice type jib. Single sheave with 12.125 in. (308 mm) pitch diameter, mounted on anti-friction bearing. Jib is extendible to 42 ft. (12.80 m) by means of a 17 ft. (5.18 m) manual pull-out tip section, roller supported for ease of extension. Under load, roller support moves to allow pad type support to carry load. Installs to main boom only.

AUXILIARY BOOM HEAD

706A8723 Removable auxiliary boom head has single metallic sheave with 12.125 in. (308 mm) pitch diameter, mounted on an anti-friction bearing. Has removable pin-type rope guard for quick reeving. Installs to main boom peak only. It is not necessary to remove when jib is erected.

HOOK BLOCK

706A8641 30 ton (27.2 mt) capacity, four metallic sheaves and hook latch. Quick reeving design complements boom head and allows reeving to be altered without the need to remove the wedge and socket from the wire rope.

HOOK & BALL

706A8725 6.25 ton (5.7 mt) top swivel ball with hook and hook latch.

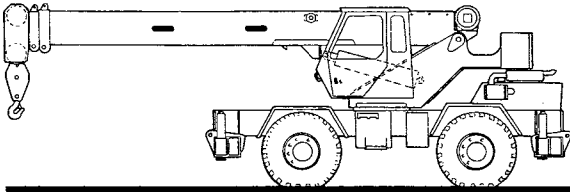

STANDARD SUPERSTRUCTURE EQUIPMENT

SUPERSTRUCTURE FRAME

All welded one-piece structure fabricated with high tensile strength alloy steel. Counterweight is bolted to frame and weighs 7,200 lbs. (3266 kg).

TURNTABLE CONNECTION

Swing bearing is single row, ball-type, with external teeth. The swing gear is bolted to revolving superstructure and welded to carrier frame. Bearing design permits load forces to be evenly distributed throughout the continuous 360° swing.

SWING

A hydraulic motor receives precisely metered flow and drives a double planetary reduction gear which provides for an extremely precise and smooth swing function. Swing speed (no load) is 3.0 rpm.

SWING BRAKE

Heavy duty, multiple disc swing brake is mechanically actuated from operator's cab by foot pedal. Brake may be set to lock and hold superstructure at any desired degree of rotation. Brake lock is released by a hand release.

TWO-BLOCK WARNING SYSTEM

Visual and audio Krueger warning system indicates an approaching two-block condition.

OPERATOR'S CAB

Environmental cab with all steel construction, optimum visibility, safety glass throughout and rubber floor matting is mounted on vibration absorbing pads. The cab has a sliding door on the left side, sliding windows on the right side, hinged tinted Lexan® skylight and removable front windshield for better visibility and ventilation.

Acoustical foam padding is used on inside cab panels for insulating against sound and weather. The deluxe six-way adjustable operator's seat includes head and arm rests.

CONTROLS

All control levers and pedals are systematically positioned for efficient operation. Hand-operated control levers include swing, boom telescope, boom hoist, single lever two-speed main winch, transmission shift, transmission forward-neutral-reverse and hand throttle. Foot control pedals include boom raise, boom lower, brake, accelerator and swing brake.

INSTRUMENTATION AND ACCESSORIES

In cab gauges include air pressure, boom angle, bubble level, engine oil pressure, fuel, engine temperature, voltmeter, transmission temperature, and transmission oil pressure. Switches include ignition, engine stop, transmission high-low range, steering mode, outrigger master, outrigger controls. Indicators include instrument warning light and buzzer, low air light and buzzer, low coolant warning light and buzzer, and two-block visual and audio Krueger warning monitor. Accessories include fire extinguisher, windshield wiper, L. H. rear view mirror, dash light, wheel wrench, quick disconnect and adapter, and swing bearing bolt adapter.

HYDRAULIC CONTROL VALVES

Valves are mounted inside the superstructure and are easily accessible. Valves include one four-spool main valve for boom hoist, telescope, main winch, and main winch boost and one single spool valve for swing. Quick disconnects are provided for quick connection of pressure check gauges.

MAIN WINCH

Lorain built hydraulic winch with planetary reduction gearing provides two-speed operation with equal speeds for power up and down. Winch is equipped with an integral automatic brake.

Performance:	Hi-Range	Lo-Range
Maximum Line Speed (no load): First Layer Fifth Layer	412 fpm (126 m/min.) 562 fpm (171 m/min.)	240 fpm (73 m/min.) 327 fpm (100 m/min.)
Maximum Line Pull: First Layer Fifth Layer	5,000 lbs (2267 kg) 3,660 lbs (1660 kg)	10,100 lbs. (4582 kg) 7,400 lbs. (3357 kg)
Permissible Line Pull:	7,600 lbs (3447 kg)	7,600 lbs. (3447 kg)
Drum Dimensions:	Drum Capacity:	
10.5 in. (267 mm) drum diameter. 16.1 in. (409 mm) length 16.6 in. (422 mm) flange diameter Cable: 1/2 in. x 500 ft. (12.7 mm x 137.2 m) Cable Type: 6 x 19 IWRC-XIPS Regular lay preformed	Maximum Storage: 815 ft. (248 m) 6th and 7th layers not working layers Maximum Usable: 540 ft. (165 m)*	
*Based on minimum flange height above top layer to comply with ANSI B30.15.		

OPTIONAL SUPERSTRUCTURE EQUIPMENT

AUXILIARY WINCH

708A2980 Lorain hydraulic winch, power up and down, equal speed, planetary reduction with integral automatic brake. 1/2 in. x 300 ft. (12.7 mm x 91.44 m) cable 6 x 19 IWRC-XIPS regular lay preformed.

Performance	
Maximum Line Speed: (Third Layer)	210 fpm (64 m/min.)
Maximum Line Pull: (First Layer)	10,900 lbs. (4944 kg)
Permissible Line Pull:	7,600 lbs. (3450 kg)
Drum Dimensions:	
Drum diameter	10.5 in. (267 mm)
Length	16.1 in. (409 mm)
Flange diameter	16.6 in. (422 mm)

708A2497 Auxiliary winch controls and plumbing only to provide for future installation of auxiliary winch.

WINCH CABLE ROLLERS

706A8035 Available for either main or auxiliary winch and is equipped with spring applied tension. Improves cable reeving.

DRUM ROTATION INDICATORS

707A6475 Touch type, mechanical system with indicator knob mounted on winch control lever available for either main or auxiliary winches.

SWING LOCK

708A2957 360° positive gear sector-type swing lock engages external swing gear for locking superstructure in any desired position. Actuated by lever located in cab.

706A8642 Swing bearing protective dust cover aids in protecting the external gear teeth.

AUTOMATIC FUNCTION DISCONNECTS FOR TWO-BLOCK WARNING SYSTEM

706A8820 Lorain automatic solenoid disconnects of main winch hoist and telescope functions to prevent a two-block condition.

706A8821 Lorain automatic solenoid disconnects of auxiliary winch and boom down functions to prevent a two-block condi-

tion used in combination with the automatic disconnects of the main winch and telescope functions.

LOAD MOMENT INDICATOR

706A8726 Krueger LMI System Mark III includes visual and audio warning system; electronic boom angle indicator with angle presets, boom length and relative load moment indications with automatic function disconnects.

COMFORT OPTIONS

708A2257 20,000 Btu propane heater and defroster (less tank). Improves visibility, productivity and operator comfort during cold weather operation.

706A8710 20,000 Btu diesel fuel type heater and defroster. Recommended for ambient temperatures below -25° F. (-32° C).

60505 Tinted safety glass.

60493 Vandal and scratch resistant glass.

60494 Tinted vandal and scratch resistant glass.

60498 Torsion suspension for six-way adjustable seat increases operator comfort and productivity.

45528 Seat belt

706A8722 Air conditioner. 21,500 Btu. Recirculating or fresh air. Improves operator comfort and productivity during hot weather operation.

706A8703 Roof window electric wiper

706A8727 Windshield washer

A56849 Tachometer

WORK LIGHTS

A37292 Three sealed beam work lights; one each mounted on boom, cab, and superstructure. All are 60 watt with 60,000 maximum candlepower. Increases machine productivity by making nighttime operation possible. Cab mounted spotlight, revolving amber beacon also available.

707A6688 Interior Dome Light eases reading of capacity charts, range diagrams, etc., during night operation.

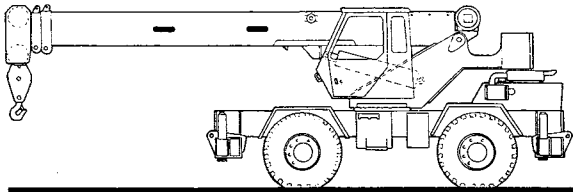

STANDARD CARRIER EQUIPMENT

CARRIER CHASSIS

Chassis is Lorain designed and built specifically for rough terrain service with four-wheel drive and four-wheel steer (4 × 4 × 4). The unitized frame is designed for maximum strength and torsional rigidity and includes box type construction with reinforcing cross members, a welded precision machined turntable mounting plate and integrally welded outrigger boxes. Decking has anti-skid surfaces. Included is lockable tool box.

AXLES AND SUSPENSION

Rear axle is a planetary drive/steer type with dual steering cylinders and automatic oscillation lockouts. The axle is free to oscillate for negotiating rough terrain when the boom is over the front. The oscillation lockouts automatically engage when the superstructure is swung 10 degrees in either direction. Four-wheel drive automatically engages in low range of transmission and automatically disengages when shifted into high range.

Front axle is a planetary drive/steer type rigid mounted to the frame for increased stability.

TIRES

16:00 × 25 - 24 P.R. lug type tubeless tires.

BRAKES

Low pedal effort air over hydraulic brakes on all wheels. Front and rear brake size is 15.75 × 4.75 in. (400 × 121 mm) on each wheel. Total brake area: 633.2 in² (4085 cm²). The combination parking and emergency brake is a spring-applied, air-released disc operating on front axle pinion shaft. Parking brake applies automatically when ignition is switched off or switch in cab is manually actuated.

STEERING

Hydraulic four-wheel power steering for two-wheel, four-wheel, or crab steer is easily controlled by steering wheel, leaving one hand free to control other crane functions.

Turning radius - 2-wheel 31 ft. 6 in. (9.60 m)
(Standard tires) 4-wheel 18 ft. 5 in. (5.61 m)

TRANSMISSION

Clark full power-shift transmission with integral torque converter has neutral safety start, 6 speeds

forward, and 6 speeds reverse. Two lever shift control (forward-neutral-reverse and 1-2-3) and two position electric range shift provide easy gear selection. An automatic dual tone, pulsating back-up alarm sounds when transmission is in reverse.

OUTRIGGERS

POWRSPAN® out and down fully independent hydraulic outriggers include easily removable steel floats each with an area of 254 in.² (1639 cm²) which are stowable on the carrier frame. Horizontal cylinders extend beams; vertical cylinders with integral hold valves level the crane. To prevent inadvertent operation of outriggers, a master switch must be activated when extending or retracting outriggers. Complete controls and sight leveling bubble are located in operator's cab.

HYDRAULIC SYSTEM

Designed for optimum efficiency and maximum flexibility. In the normal operating mode, all crane functions, main winch, swing, boom hoist, and telescope may be operated simultaneously. If fast cycling is desired, the critical crane functions - main winch and boom extend - are provided with two-speed capability.

Hydraulic Reservoir

All steel, welded construction with internal baffles and diffuser. Provides easy access to filters and is equipped with an external sight level gauge. The hydraulic tank is pressurized to aid in keeping out contaminants and in reducing potential pump cavitation. Capacity is 81 gallons (307 l).

Filtration

Full flow oil filtration system with bypass protection includes a removable 100 mesh (140 micron) suction screen-type filter and a 3 micron replaceable return line filter.

Hydraulic Pumps

Three gear type pumps, one single and two in tandem, driven off the transmission. The tandem pump may be disconnected for travel by means of a convenient lever located on the carrier deck. Combined system capability is 115 gpm (435 lpm). Pumps include:

Main Winch Pump

54 gpm (204.4 lpm) @ 3200 PSI (225.3 kg/cm²). High speed boost is provided from boom hoist circuit.

Boom Hoist, Telescope and Auxiliary Winch Pump.

40 gpm (151.4 lpm) @ 3500 PSI (246 kg/cm²).

Power Steering, Outrigger and Swing Pump.

21 gpm (79.5 lpm) @ 2500 PSI (175 kg/cm²).

ENGINE SPECIFICATIONS

MAKE & MODEL	(Standard) GM 3-53T	60662 (Optional) Caterpillar 3208
Type	3-cylinder	8-cylinder
Bore and Stroke	3.875 x 4.50 in. (98.4 x 114.3 mm)	4.5 x 5.0 in. (114.3 x 127.0 mm)
Displacement	159 cu. in. (2.6 l)	636 cu. in. (10.4 l)
Max. Gross Horsepower	125 hp (93 kw) @ 2500 rpm	132 hp (98 kw) @ 2500 rpm
Max. Gross Torque	302 ft. lbs. (42 kg m) @ 1600 rpm	305 ft. lbs. (42 kg m) @ 1400 rpm
Net Horsepower	114 hp (85 kw) @ 2500 rpm	121 hp (90 kw) @ 2500 rpm
Aspiration	turbocharged	natural
Air Filter	dry type	dry type
Electric System	12 volt	12 volt
Alternator	42 amp	60 amp
Battery	(2) 12 V - 1250 C.C.A.	(3) 12 V - 1875 C.C.A.
Fuel Capacity	50 gal. (189 l)	50 gal. (189 l)

OPTIONAL CARRIER EQUIPMENT

TIRES

60656 20.5 x 25 - 24 P.R. (lug type) tubeless.

AXLES

60680 No-spin Rear Planetary Drive/Steer Axle. Provides full power transfer from spinning wheel to the wheel with traction.

60679 Limited slip for front and rear planetary drive/steer axles. Provides for transfer of a portion of the lost power from a spinning wheel on either axle to the other wheel. This feature avoids wear and tear of axle drive shafts encountered by locking type differentials on hard surfaces.

COLD WEATHER STARTING AID

193 Measured shot ether injection system to aid engine start-up in cold weather conditions. Temperature switch protects hot engine.

IMMERSION HEATER

A38556 110 volt, 60 cycle, 2500 watt heater for hydraulic oil reservoir. Used to heat oil in very cold weather conditions for easy start-up operation.

HYDRAULIC OIL COOLER

708A2983 Fin and tube air-cooled type with bypass protection from high oil pressure caused by cold weather conditions. Recommended for continuous duty cycle applications or very high ambient temperatures. Tilt-out feature allows easy cleaning of oil cooler and radiator.

AUXILIARY STEERING

60682 Automatically provides emergency steering in the event of engine stall while traveling forward. Pump is driven off transmission gears which remain in motion as long as the wheels are turning.

PERFORMANCE

Trans- mission Range	Gear	Forward Drive	Maximum Speed	Maximum Tractive Effort	Gradeability @ Stall
LOW	1	4-Wheel	2.0 mph 3.2 km/h	48,352 lbs. 21,932 kg.	131.4%
	2	4-Wheel	3.8 mph 6.1 km/h	24,592 lbs. 11,155 kg.	52.5%
	3	4-Wheel	10.8 mph 17.4 km/h	8,215 lbs. 3,726 kg.	14.1%
HIGH	1	2-Wheel	4.4 mph 7.1 km/h	21,576 lbs. 9,787 kg.	44.3%
	2	2-Wheel	8.3 mph 13.4 km/h	10,970 lb. 4,976 kg.	19.8%
	3	2-Wheel	23.0 mph 37.0 km/h	3,639 lb. 1,651 kg.	5.0%

All performance data is based on a gross vehicle weight of 51,180 lb. (23,215 kg.), 16:00 x 25 tires, 4 x 4 drive, and GM 3-53T engine. Performance may vary due to engine performance. Gradeability data is theoretical and is limited by tire slip, stability, or engine oil pan design (20°-GM, 33°-CAT).

FENDERS

708A2758 Front and rear.

PINTLE HOOK

60235 Pintle hook available for front and/or rear.

LIGHTS/MIRROR

708A2088 Headlights, tail lights, clearance lights, turn signals and hazard flashers.

706A8724 Back-up lights.

706A8764 Right hand rear view mirror.

706A8760 Tool kit, service and maintenance tools, including toolbox.

Weights & Axle Loads

	GROSS WEIGHT LBS.	UPPER FACING FRONT		GROSS WEIGHT KG.	UPPER FACING FRONT	
		FRONT	REAR		FRONT	REAR
Basic Crane <i>N. Bam.</i>	48,255	26,780	21,475	21,888	12,147	9,741
Add Options:						
15'-20' (4.57-6.10m) Jib (Stowed)	+ 610	+ 1330	- 720	+ 277	+ 603	- 326
25' (7.62m) Swing-On Jib (Stowed)	+ 850	+ 1450	- 600	+ 386	+ 658	- 272
25'-42' (7.62-12.80m) Swing-On Jib (Stowed)	+ 1150	+ 1950	- 800	+ 522	+ 855	- 363
Auxiliary Boom Head	+ 100	+ 315	- 215	+ 45	+ 143	- 98
30 ton (27.2mt) Hook Block	+ 427	+ 740	- 313	+ 194	+ 336	- 142
Hook and Ball (In Tool Box)	+ 121	+ 145	- 24	+ 55	+ 66	- 11
Auxiliary Winch with Wire Rope	0	0	0	0	0	0
Fenders (4)	+ 640	+ 320	+ 320	+ 290	+ 145	+ 145
Hydraulic Oil Cooler	+ 150	- 60	+ 210	+ 68	- 27	+ 95
Pintle Hook						
Front	+ 45	+ 70	- 25	+ 20	+ 32	- 11
Rear	+ 45	- 25	+ 70	+ 20	- 11	+ 32
Substitute:						
44' (13.41m) Boom	- 3435	- 6350	+ 2915	- 1558	- 2880	+ 1322
61' (18.74m) Boom	- 1365	- 3615	+ 2250	- 619	- 1640	+ 1021
94' (28.78m) Boom	+ 1105	+ 1710	- 605	+ 501	+ 776	- 274
Cat 3208 Engine	+ 340	- 30	+ 370	+ 154	- 14	+ 168
20.5 x 25 Tires	+ 460	+ 230	+ 230	+ 140	+ 70	+ 70

NOTE: Weights are for Lorain supplied equipment.

LORAIN has what it takes to fill your lifting requirements — wide selection.

ROUGH TERRAIN CRANES — the *quality* buy in fast moving lift performance. Automatic self-proportioning booms, in-house designed and built winches, rugged Lorain carriers and more.

LATTICE BOOM CRANES — here's capability application in long reach and big lift capabilities. Cranes that provide the ultimate in control, ease of travel and quick jobsite setup.

MOBILE TOWER CRANES — exceptional reach and the ability to work in-close, in tight quarters make these machines the big winners on toughest lifting jobs.

HYDRAULIC-CARRIER-MOUNTED CRANES — you'll find these are more than just great lifting machines. They're highly mobile. Fast. Maneuverable. Deliver more time on the job, less time between jobs. Lorain booms, winches and hydraulic control make load spotting quick and easy.

WE RESERVE THE RIGHT TO AMEND THESE SPECIFICATIONS AT ANY TIME WITHOUT NOTICE. THE ONLY WARRANTY APPLICABLE IS OUR STANDARD WRITTEN WARRANTY APPLICABLE TO THE PARTICULAR PRODUCT AND SALE. WE MAKE NO OTHER WARRANTY, EXPRESSED OR IMPLIED.



**KOEHRING CRANES
& EXCAVATORS**
AMCA
INTERNATIONAL



**KOEHRING CRANES
& EXCAVATORS**

**AMCA
INTERNATIONAL**

LORAIN LRT 230

rough terrain crane
23 ton capacity
range diagrams &
capacity charts

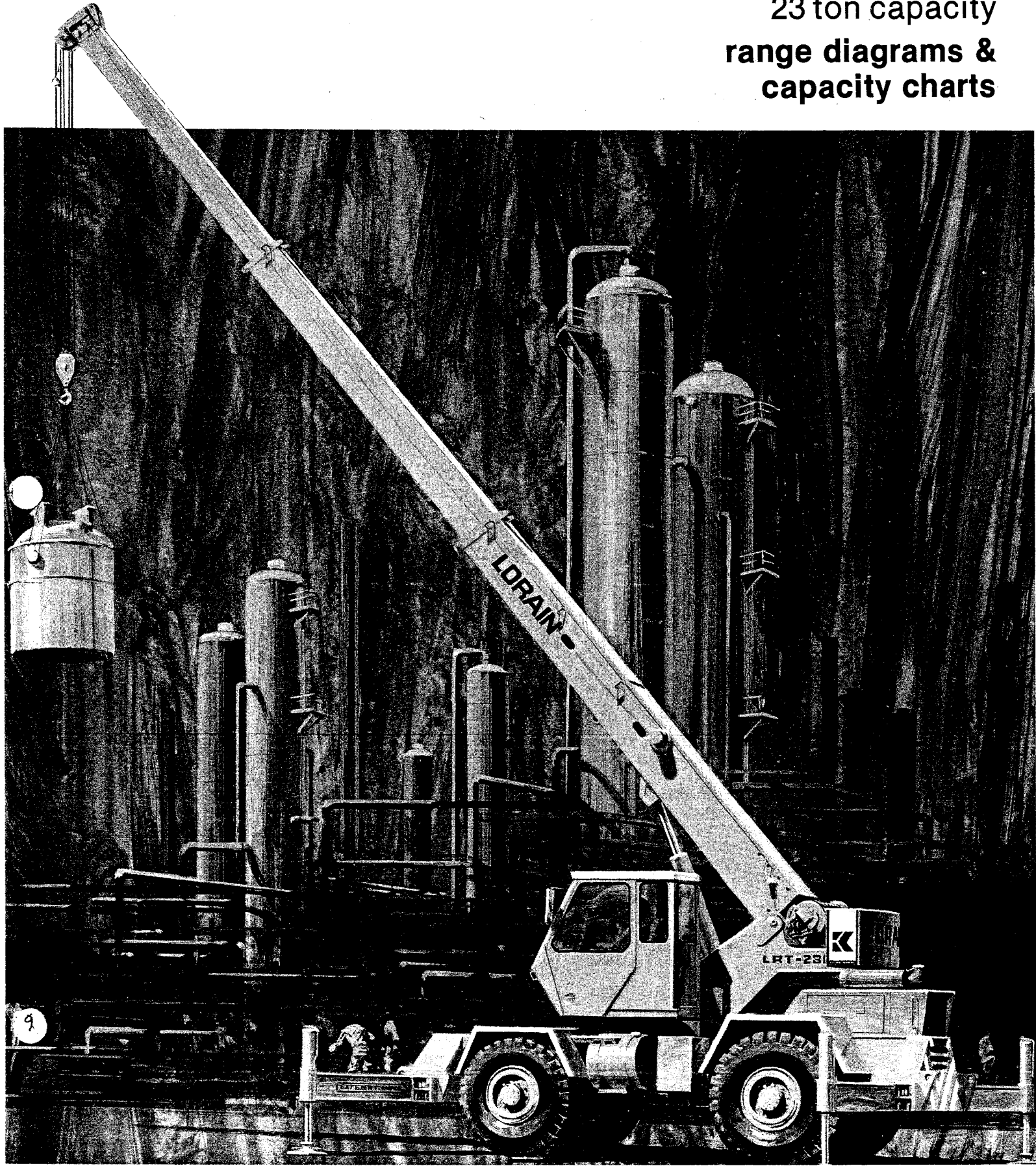

9

Range Diagram (26.5'-44' boom)

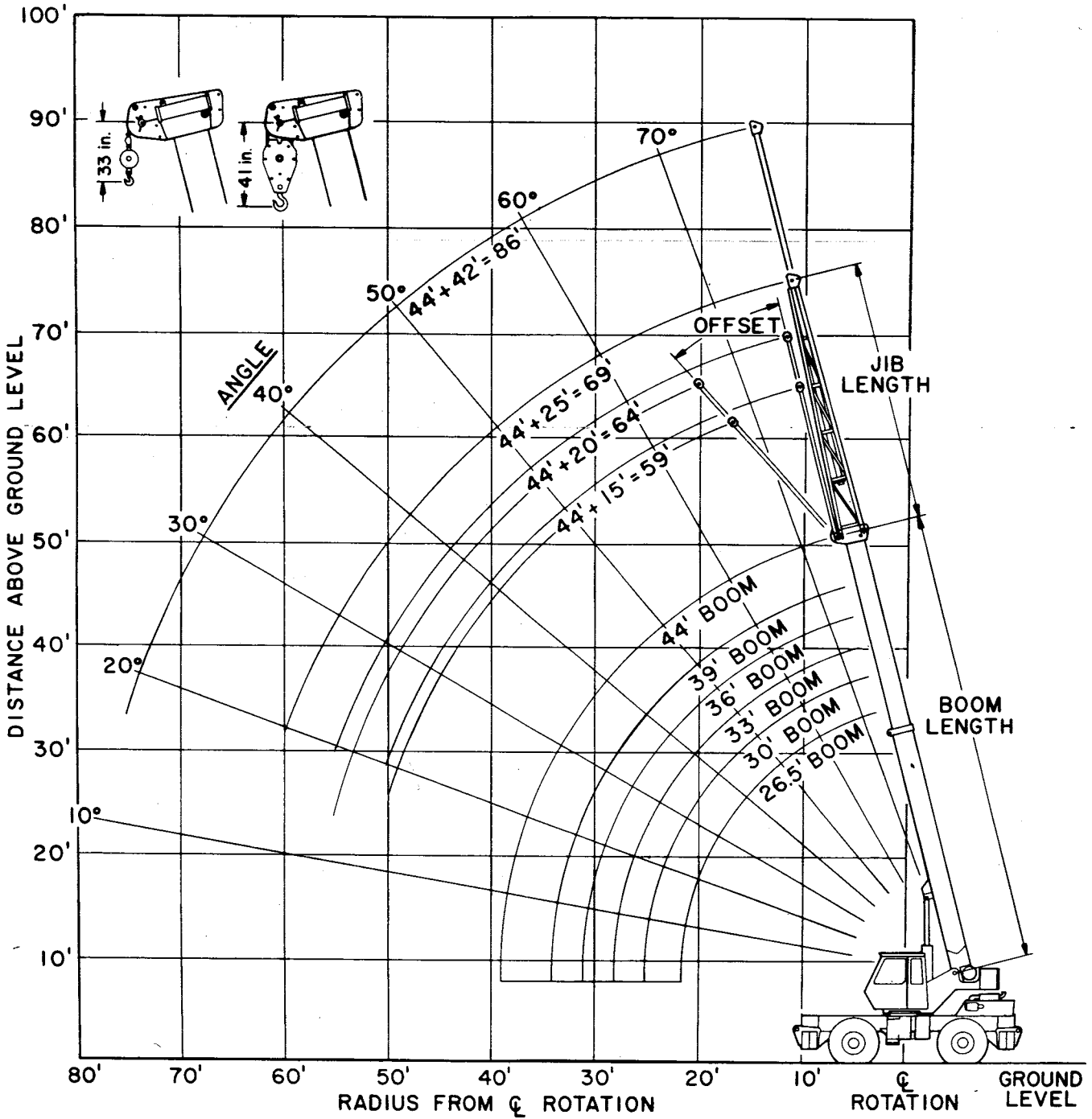



KOEHRING CRANES & EXCAVATORS

ANCA INTERNATIONAL

MODEL LRT 230

COUNTERWEIGHT
 W/AUX. WINCH 6100 lb.
 W/O AUX. WINCH 7200 lb.
 BOOM LENGTH 26.5-44 ft.
 OUTRIGGER SPREAD 18 ft.
 STABILITY PCT.
 ON OUTRIGGERS 85%
 ON TIRES 75%

Capacity Charts — Pounds

ON OUTRIGGERS

R A D I U S	BOOM LENGTH 26.5 ft.				BOOM LENGTH 30 ft.				BOOM LENGTH 33 ft.				BOOM LENGTH 36 ft.				BOOM LENGTH 39 ft.				BOOM LENGTH 44 ft.				R A D I U S
	∠	Front	360°	∠	Front	360°	∠	Front	360°	∠	Front	360°	∠	Front	360°	∠	Front	360°	∠	Front	360°				
10	61	46,000*	46,000*	65	46,000*	46,000*	68	46,000*	46,000*	70	46,000*	46,000*	72	46,000*	46,000*	74	46,000*	46,000*	10						
12	55	46,000*	46,000*	60	46,000*	46,000*	64	45,800*	45,800*	66	44,700*	44,700*	69	43,700*	43,700*	72	42,400*	42,400*	12						
15	46	38,800*	38,800*	53	39,000*	39,000*	57	39,100*	39,100*	61	39,100*	39,100*	64	38,400*	38,400*	68	37,100*	37,100*	15						
20	26	28,200*	28,200*	39	28,400*	28,400*	46	28,500*	28,500*	51	28,500*	28,500*	55	28,600*	28,600*	60	28,700*	28,700*	20						
25				13	21,900*	21,000*	30	22,100*	21,200*	38	22,100*	21,300*	44	22,200*	21,400*	52	22,300*	21,500*	25						
30										20	17,700	15,400	31	17,800	15,500	43	17,900	15,700	30						
35																30	13,900	12,100	35						

ON TIRES

R A D I U S	M A X. ∠	M I N. ∠	16:00 x 25 - 24 P.R.				20.5 x 25 - 24 P.R.				R A D I U S
			STATIONARY		PICK & CARRY		STATIONARY		PICK & CARRY		
					CREEP	2.5 MPH			CREEP	2.5 MPH	
			360°	ST. OVER FRONT	360°	ST. OVER FRONT	360°	ST. OVER FRONT	360°	ST. OVER FRONT	
10	63	63	19,400	37,200	34,500*	24,900*	19,600	35,700*	27,700*	19,100*	10
12	57	57	15,800	29,300	29,300	21,700*	15,900	29,600	24,100*	16,500*	12
15	48	48	10,800	20,200	20,200	18,000*	10,900	20,400	20,400	13,600*	15
20	45	28	7,000	12,400	12,400	12,400	7,100	12,500	12,500	10,100*	20
25	40	0	4,500	8,500	8,500	8,500	4,600	8,600	8,600	8,000*	25
30	35	0	3,200	6,300	6,300	6,300	3,300	6,300	6,300	6,300	30
35	32	0	2,300	3,600	3,600	3,600	2,300	4,800	4,800	4,800	35

Notes for On Tire Capacities:

- For Pick and Carry operation, boom must be centered over the front of the crane with swing brake locked or with mechanical swing lock engaged if crane is so equipped.
- The load should be restrained from swinging.
- Without outriggers never maneuver the boom beyond listed load radii for applicable tires used to ensure stability.
- Creep speed is crane movement of less than 200 ft. (61 m) in a 30 minute period and not exceeding 1.0 mph (1.6 km/h).
- Refer to General Notes for additional information.

STOW-AWAY JIB

R A D I U S	15 - 20 FT. JIB								R A D I U S
	15 FT. LENGTH				20 FT. LENGTH				
	∠	No Offset	24° Offset	∠	∠	No Offset	24° Offset	∠	
15	75	6000*							15
20	70	6000*	74	6000*	72	6000*			20
25	64	6000*	69	5700*	67	6000*	73	4100*	25
30	58	6000*	63	5200*	62	5700*	67	3700*	30
35	52	6000*	56	4900*	56	4800*	62	3500*	35
40	45	6000*	49	4700*	50	4200*	56	3300*	40
45	37	6000*	41	4500*	44	3700*	49	3200*	45
50	25	6000*	29	4300*	36	3400*	40	3100*	50
55					25	3200*	29	2900*	55

Notes for Jib Capacities:

- For all boom lengths less than the maximum with a jib erected, the rated loads are determined by boom angle only in the appropriate column.
- For boom angles not shown, use the capacity of the next lower boom angle.
- Listed radii are for fully extended main boom only.

SIDE-STOW JIB

R A D I U S	25 FT. & 25-42 FT. JIB				R A D I U S
	∠	25 ft. Length	∠	42 ft. Length	
20	73	10,100*			20
25	68	9000*	73	4500*	25
30	64	7900*	70	4100*	30
35	59	7000*	66	3800*	35
40	54	6400*	62	3500*	40
45	48	5800*	58	3200*	45
50	41	5300*	54	3000*	50
55	34	4900*	50	2800*	55
60	25	4700*	45	2600*	60
65			40	2500*	65
70			33	2300*	70
75			26	2200*	75

RECOMMENDED TIRE PRESSURES

	STATIONARY	CREEP	2-1/2 MPH	TRAVEL
16:00x25-24 P.R.	115 PSI	115 PSI	95 PSI	80 PSI
20.50x25-24 P.R.	80 PSI	80 PSI	65 PSI	65 PSI

MAX. PERMISSIBLE HOIST LINE LOAD

LINE PARTS	1	2	3	4	5	6	7
MAX. LOAD	7,600	15,200	22,800	30,400	38,000	45,600	46,000
BOOM HEAD	2	2-D	2-3	1-2-D	1-2-3	1-2-3-D	1-2-3-4
HOOK BLOCK	D	2	2-D	1-2	1-2-D	1-2-3	1-2-3-D
WIRE ROPE:	6x19 or 6x37 Class, 26,600 lbs. Min. Breaking Strength 1/2" Diameter, X.I.P.S., I.W.R.C., Preformed 9/16" Diameter, I.P.S., W.R.C., Preformed 5/8" Diameter, P.S., I.W.R.C., Preformed						

CRANE WORKING POSITIONS

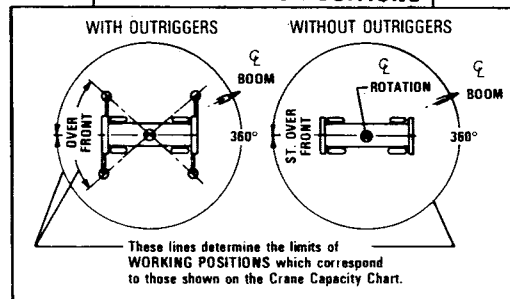

REDUCTION IN MAIN BOOM CAPACITY

All Jibs in Stowed	0 Lbs.
Position	0 Lbs.
15'-20' Stowaway	
Jib Erected	1,030 Lbs.
25' Side Stow Jib, Erected	2,050 Lbs.
42' Side Stow Jib, Erected	2,520 Lbs.
Aux. Boom Head	
Sheave	100 Lbs.

HOOK BLOCK WEIGHTS

Hook & Ball	121 Lbs.
Hook Block (2-Sheave)	330 Lbs.
Hook Block (3-Sheave)	360 Lbs.
Hook Block (4-Sheave)	427 Lbs.

Range Diagram (26.5'-61' boom)

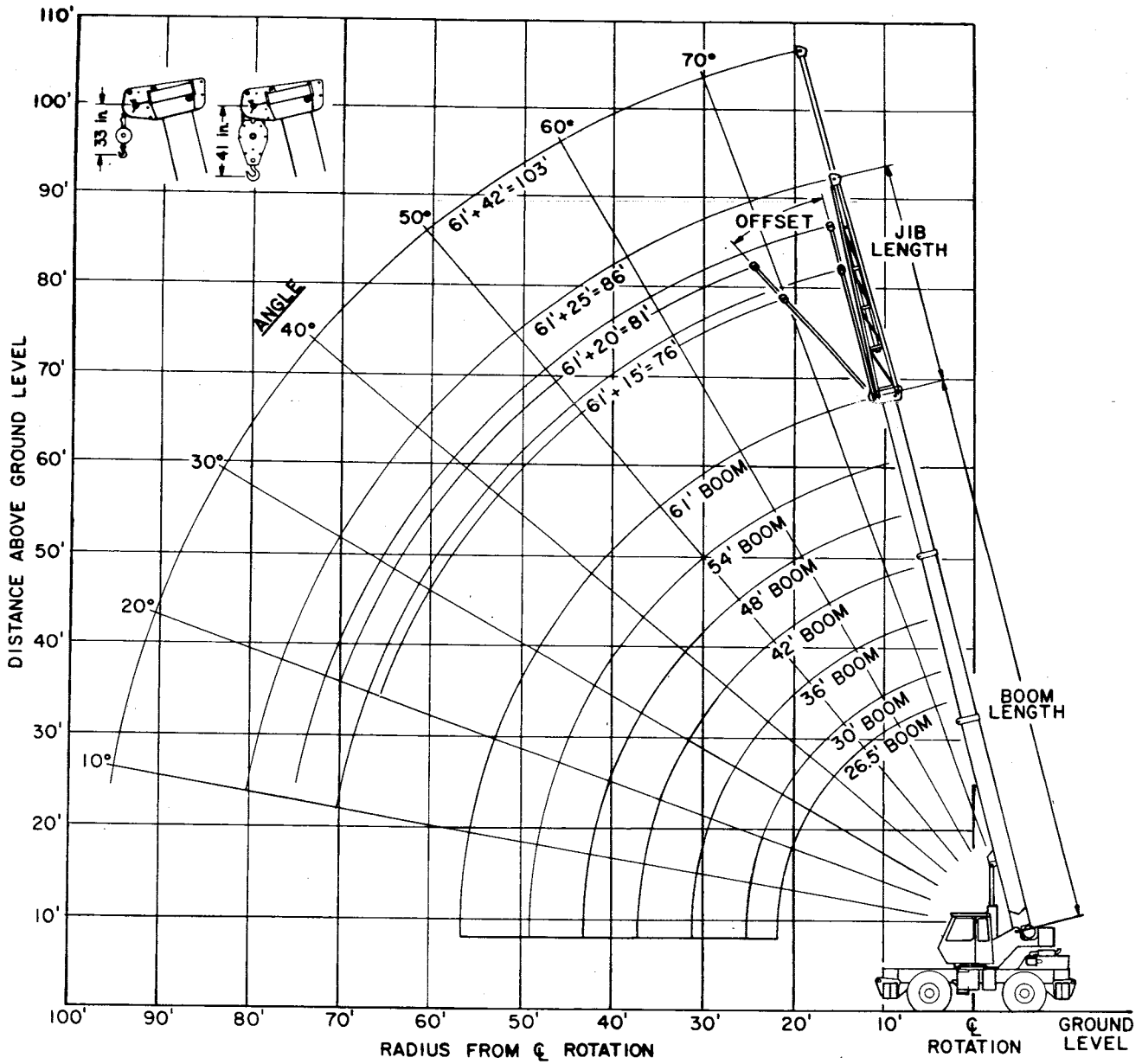



KOEHRING CRANES & EXCAVATORS

AMCA INTERNATIONAL

MODEL LRT 230

COUNTERWEIGHT
 W/AUX. WINCH 6100 lb.
 W/O AUX. WINCH 7200 lb.
 BOOM LENGTH 26.5-61 ft.
 OUTRIGGER SPREAD 18 ft.
 STABILITY PCT.
 ON OUTRIGGERS 85%
 ON TIRES 75%
 PCSA CLASS 12.98

Capacity Charts — Pounds

ON OUTRIGGERS

R A D I U S	BOOM LENGTH 26.5 ft.		BOOM LENGTH 30 ft.		BOOM LENGTH 36 ft.		BOOM LENGTH 42 ft.		BOOM LENGTH 48 ft.		BOOM LENGTH 54 ft.		BOOM LENGTH 61 ft.		R A D I U S	
	⚡	360°	⚡	360°	⚡	360°	⚡	360°	⚡	360°	⚡	360°	⚡	360°		
	Front	360°	Front	360°	Front	360°	Front	360°	Front	360°	Front	360°	Front	360°		
10	60	46,000*	46,000*	64	46,000*	46,000*	69	46,000*	46,000*	72	44,300*	44,300*	75	39,300*	39,300*	10
12	55	46,000*	46,000*	60	46,000*	46,000*	66	44,300*	44,300*	70	41,200*	41,200*	73	36,500*	36,500*	12
15	46	38,500*	38,500*	53	38,600*	38,600*	60	38,900*	38,900*	66	37,400*	37,400*	69	32,900*	32,900*	15
20	26	27,700*	27,700*	39	27,900*	27,900*	50	28,200*	28,200*	58	28,300*	28,300*	63	28,300*	28,300*	20
25				13	21,400*	21,400*	38	21,700*	21,700*	49	21,800*	21,800*	55	22,000*	22,000*	25
30							19	17,300*	15,800	38	17,500*	16,100	48	17,600*	16,200	30
35										23	13,800	12,300	38	14,000	12,400	35
40													26	11,100	9,800	40
45																45
50																50
55																55

ON TIRES

R A D I U S	M A X.	M I N.	16:00 x 25 - 24 P.R.				20.5 x 25 - 24 P.R.				R A D I U S
			STATIONARY		PICK & CARRY		STATIONARY		PICK & CARRY		
					CREEP 2.5 MPH				CREEP 2.5 MPH		
			360°	ST. OVER FRONT	360°	ST. OVER FRONT	360°	ST. OVER FRONT	360°	ST. OVER FRONT	
10	62	62	19,900	38,200	34,000*	24,400*	20,100	35,100*	27,100*	18,500*	10
12	57	57	15,900	29,800	29,600*	21,100*	16,100	30,100	23,500*	15,900*	12
15	48	48	11,000	20,300	20,300	17,300*	11,100	20,500	19,400*	12,900*	15
20	45	28	7,500	12,500	12,500	12,500	7,600	12,600	12,600	9,400*	20
25	40	0	4,900	9,000	9,000	9,000	5,000	8,800	8,800	7,100*	25
30	35	0	3,500	6,400	6,400	6,400	3,500	6,400	6,400	5,700*	30
35	32	0	2,400	4,800	4,800	4,800	2,500	4,900	4,900	4,600*	35
40	30	0	1,600	3,800	3,800	3,800	1,600	3,900	3,900	3,700*	40
45	28	0		3,000	3,000	3,000		3,100	3,100	3,000*	45
50	26	0		2,400	2,400	2,400		2,500	2,500	2,400*	50
55	24	0		1,800	1,800	1,800		1,800	1,800	1,800	55

Notes for On Tire Capacities:

- For Pick and Carry operation, boom must be centered over the front of the crane with swing brake locked or with mechanical swing lock engaged if crane is so equipped.
- The load should be restrained from swinging.
- Without outriggers never maneuver the boom beyond listed load radii for applicable tires used to ensure stability.
- Creep speed is crane movement of less than 200 ft. (61 m) in a 30 minute period and not exceeding 1.0 mph (1.6 km/h).
- Refer to General Notes for additional information.

STOW-AWAY JIB

R A D I U S	15 - 20 FT. JIB								R A D I U S
	15 FT. LENGTH				20 FT. LENGTH				
	⚡	No Offset	24°	Offset	⚡	No Offset	24°	Offset	
20	75	6000*							20
25	71	6000*	75	6000*	73	6000*			25
30	67	6000*	71	5900*	69	6000*	74	4200*	30
35	63	6000*	66	5400*	65	6000*	69	4000*	35
40	58	6000*	61	5200*	60	5500*	65	3800*	40
45	53	6000*	56	4900*	56	5000*	61	3600*	45
50	48	6000*	51	4700*	52	4500*	57	3500*	50
55	42	5500	45	4600*	47	4000*	51	3300*	55
60	36	4600	39	4500*	41	3600*	45	3100*	60
65	28	3800	30	3900	35	3400*	38	3000*	65
70	16	3200			27	3200*	30	2900*	70
75					14	2900			75

Notes for Jib Capacities:

- For all boom lengths less than the maximum with a jib erected, the rated loads are determined by boom angle only in the appropriate column.
- For boom angles not shown, use the capacity of the next lower boom angle.
- Listed radii are for fully extended main boom only.

SIDE-STOW JIB

R A D I U S	25 FT. & 25-42 FT. JIB				R A D I U S
	25 ft. Length		42 ft. Length		
	⚡	25 ft. Length	⚡	42 ft. Length	
25	74	10,300*			25
30	70	9400*	74	4600*	30
35	66	8400*	71	4200*	35
40	63	7700*	68	3900*	40
45	58	7000*	65	3700*	45
50	54	6500*	61	3400*	50
55	50	5700	58	3200*	55
60	45	4800	55	3000*	60
65	40	4100	51	2900*	65
70	34	3500	47	2700*	70
75	26	3000	43	2600*	75
80	15	2500	38	2500*	80
85			33	2300*	85
90			27	2200*	90
95			19	2000	95

RECOMMENDED TIRE PRESSURES

	STATIONARY	CREEP	2-1/2 MPH	TRAVEL
16:00x25—24 P.R.	115 PSI	115 PSI	95 PSI	80 PSI
20.50x25—24 P.R.	80 PSI	80 PSI	65 PSI	65 PSI

MAX. PERMISSIBLE HOIST LINE LOAD

LINE PARTS	1	2	3	4	5	6	7
MAX. LOAD	7,600	15,200	22,800	30,400	38,000	45,600	46,000
BOOM HEAD	2	2-D	2-3	1-2-D	1-2-3	1-2-3-D	1-2-3-4
HOOK BLOCK	D	2	2-D	1-2	1-2-D	1-2-3	1-2-3-D

WIRE ROPE: 6x19 or 6x37 Class, 26,600 lbs. Min. Breaking Strength
 1/2" Diameter, X.I.P.S., I.W.R.C., Preformed
 9/16" Diameter, I.P.S., W.R.C., Preformed
 5/8" Diameter, P.S., I.W.R.C., Preformed

CRANE WORKING POSITIONS

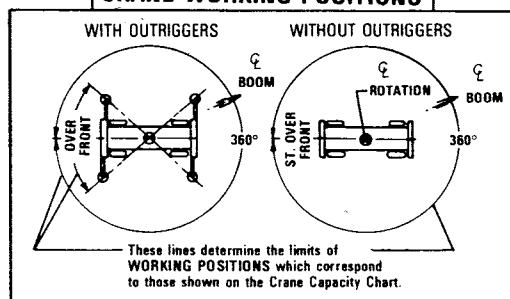

REDUCTION IN MAIN BOOM CAPACITY

Position	0 Lbs.
All Jibs in Stowed	0 Lbs.
15'-20' Stowaway	0 Lbs.
Jib Erected	1,030 Lbs.
25' Side Stow Jib, Erected	2,050 Lbs.
42' Side Stow Jib, Erected	2,520 Lbs.
Aux. Boom Head	100 Lbs.
Sheave	100 Lbs.

HOOK BLOCK WEIGHTS

Hook & Ball	121 Lbs.
Hook Block (2 Sheave)	330 Lbs.
Hook Block (3 Sheave)	360 Lbs.
Hook Block (4 Sheave)	427 Lbs.

Range Diagram (30'-72' boom)

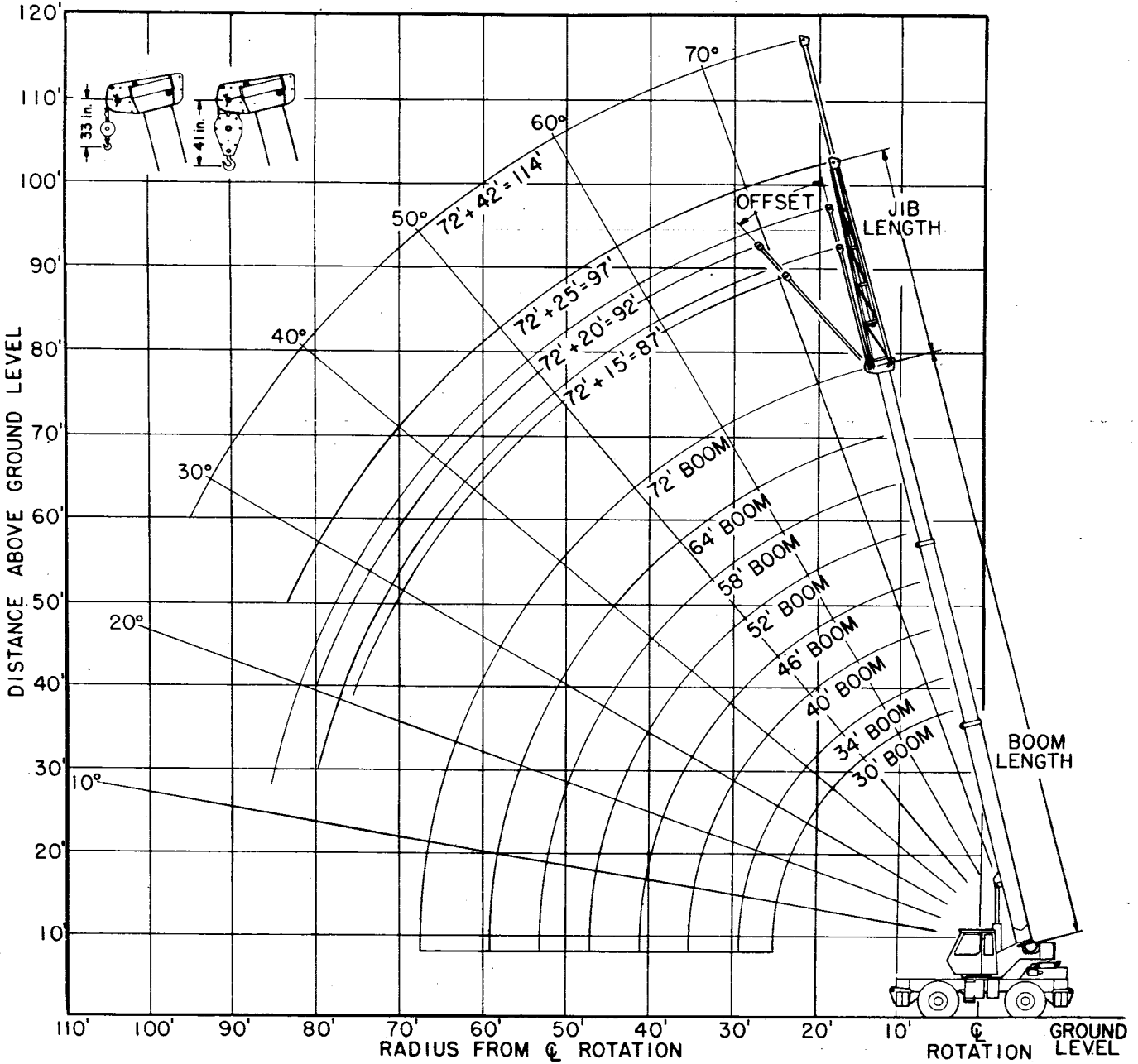



Capacity Charts — Pounds

ON OUTRIGGERS

RADII	BOOM LENGTH 30 ft.		BOOM LENGTH 34 ft.		BOOM LENGTH 40 ft.		BOOM LENGTH 46 ft.		BOOM LENGTH 52 ft.		BOOM LENGTH 58 ft.		BOOM LENGTH 64 ft.		BOOM LENGTH 72 ft.		RADII												
	Front	360°	Front	360°	Front	360°	Front	360°	Front	360°	Front	360°	Front	360°	Front	360°													
	⚡	⚡	⚡	⚡	⚡	⚡	⚡	⚡	⚡	⚡	⚡	⚡	⚡	⚡	⚡	⚡													
10	65	46,000*	46,000*	68	46,000*	46,000*	72	46,000*	46,000*	75	45,000*	45,000*					10												
12	61	45,100*	45,100*	65	43,700*	43,700*	69	41,800*	41,800*	72	40,300*	40,300*	75	37,800*	37,800*		12												
15	54	37,100*	37,100*	59	37,300*	37,300*	64	36,400*	36,400*	68	35,000*	35,000*	71	33,900*	33,900*	73	30,600*	30,600*	75	29,000*	29,000*								
20	40	26,300*	26,300*	47	26,500*	26,500*	56	26,700*	26,700*	61	26,800*	26,800*	65	27,000*	27,000*	68	26,300*	26,300*	71	25,300*	25,300*	75	21,300*	21,300*	20				
25	16	19,600*	19,600*	33	19,900*	19,900*	46	20,200*	20,200*	53	20,300*	20,300*	59	20,400*	20,400*	63	20,500*	20,500*	66	20,600*	20,600*	70	19,000*	19,000*	25				
30							34	15,800*	15,800*	45	16,000*	16,000*	52	16,100*	16,100*	57	16,200*	16,200*	61	16,200*	16,200*	66	16,000*	16,000*	30				
35							11	12,600*	12,200*	34	12,800*	12,500*	45	12,900*	12,700*	51	13,000*	12,800*	56	13,100*	12,900*	61	13,200*	13,000*	35				
40										18	10,400*	9,600*	35	10,600*	9,800*	44	10,700*	9,900*	50	10,800*	10,000*	58	10,900*	10,100*	40				
45													22	8,700*	7,700*	35	8,900*	7,800*	43	8,900*	7,900*	51	9,000*	8,000*	45				
50																24	7,200*	6,300*	36	7,400*	6,400*	45	7,500*	6,500*	50				
55																			25	6,000*	5,100*	39	6,100*	5,200*	55				
60																									31	5,000*	4,200*	60	
65																										21	4,100*	3,400*	65

ON TIRES

RADII	MAX.	MIN.	16:00 x 25 - 24 P.R.				20.5 x 25 - 24 P.R.				RADII
			STATIONARY		PICK & CARRY		STATIONARY		PICK & CARRY		
			Creep	2.5 MPH	Creep	2.5 MPH	Creep	2.5 MPH	Creep	2.5 MPH	
10	67	67	20,900	40,800	35,300*	25,700*	20,700*	36,500*	28,400*	19,900*	10
12	63	63	16,200	31,300	30,600*	22,100*	16,200*	31,500	24,500*	17,000*	12
15	56	56	10,700	20,900	20,900	18,000*	10,800	21,100	20,100*	13,600*	15
20	50	42	6,100	12,400	12,400	12,400	6,800	13,100	13,100	9,800*	20
25	47	18	3,500	8,200	8,200	8,200	4,200	8,900	8,900	7,100*	25
30	45	0	2,000	5,700	5,700	5,700	2,400	6,000	6,000	5,300*	30
35	42	0		4,000	4,000	4,000	1,800	4,400	4,400	4,100*	35
40	40	0		3,100	3,100	3,100	1,400	3,300	3,300	3,100*	40
45	38	0		2,300	2,300	2,300		2,400	2,400	2,400*	45
50	35	0		1,600	1,600	1,600		1,700	1,700	1,700	50

Notes for On Tire Capacities:

- A. For Pick and Carry operation, boom must be centered over the front of the crane with swing brake locked or with mechanical swing lock engaged if crane is so equipped.
- B. The load should be restrained from swinging.
- C. Without outriggers never maneuver the boom beyond listed load radii for applicable tires used to ensure stability.
- D. Creep speed is crane movement of less than 200 ft. (61 m) in a 30 minute period and not exceeding 1.0 mph (1.6 km/h).
- E. Refer to General Notes for additional information.

RECOMMENDED TIRE PRESSURES

	STATIONARY	CREEP	2-1/2 MPH	TRAVEL
16:00x25—24 P.R.	115 PSI	115 PSI	95 PSI	80 PSI
20.50x25—24 P.R.	80 PSI	80 PSI	65 PSI	65 PSI

MAX. PERMISSIBLE HOIST LINE LOAD

LINE PARTS	1	2	3	4	5	6	7
MAX. LOAD	7,600	15,200	22,800	30,400	38,000	45,600	46,000
BOOM HEAD	2	2-D	2-3	1-2-D	1-2-3	1-2-3-D	1-2-3-4
HOOK BLOCK	D	2	2-D	1-2	1-2-D	1-2-3	1-2-3-D
WIRE ROPE:	6x19 or 6x37 Class, 26,600 lbs. Min. Breaking Strength 1/2" Diameter, X.I.P.S., I.W.R.C., Preformed 9/16" Diameter, I.P.S., W.R.C., Preformed 5/8" Diameter, P.S., I.W.R.C., Preformed						

STOW-AWAY JIB

RADII	15 - 20 FT. JIB						RADII		
	15 FT. LENGTH			20 FT. LENGTH					
	No Offset	24° Offset	24° Offset	No Offset	24° Offset	24° Offset			
25	74	6000*		75	6000*		25		
30	71	6000*	74	6000*	72	6000*	75	4500*	30
35	67	6000*	70	5800*	69	6000*	73	4100*	35
40	63	6000*	66	5400*	65	6000*	69	3800*	40
45	60	6000*	62	5200*	62	5900*	66	3600*	45
50	56	6000*	58	5000*	58	5100*	62	3500*	50
55	52	5600*	54	4800*	54	4600*	58	3400*	55
60	47	4700*	49	4700*	50	4200*	53	3200*	60
65	42	3900*	44	4100*	46	3900*	49	3200*	65
70	37	3200*	38	3400*	41	3500*	44	3100*	70
75	30	2700*	31	2800*	35	2900*	38	2900*	75
80	21	2200*		29	2400*	30	2600*	80	
85				20	2000*			85	

Notes for Jib Capacities:

- F. For all boom lengths less than the maximum with a jib erected, the rated loads are determined by boom angle only in the appropriate column.
- G. For boom angles not shown, use the capacity of the next lower boom angle.
- H. Listed radii are for fully extended main boom only.

SIDE-STOW JIB

RADII	25 FT. & 25-42 FT. JIB				RADII
	25 ft. Length		42 ft. Length		
	⚡	⚡	⚡	⚡	
25	75	11,000*			25
30	72	10,100*	75	4800*	30
35	69	9100*	73	4500*	35
40	66	8100*	70	4100*	40
45	63	7200*	68	3900*	45
50	59	6100*	64	3700*	50
55	56	5000*	62	3500*	55
60	52	4000*	59	3300*	60
65	47	3300*	56	3100*	65
70	42	2600*	53	2900*	70
75	37	2100*	49	2800*	75
80	32	1600*	45	2400*	80
85	26	1200*	42	2000*	85
90			39	1600*	90
95			34	1300*	95

REDUCTION IN MAIN BOOM CAPACITY

All Jibs in Stowed Position	0 Lbs.
15'-20' Stowaway Jib Erected	950 Lbs.
25' Side Stow Jib, Erected	1,850 Lbs.
42' Side Stow Jib, Erected	2,210 Lbs.
Aux. Boom Head Sheave	100 Lbs.

HOOK BLOCK WEIGHTS

Hook & Ball	121 Lbs.
Hook Block (2-Sheave)	330 Lbs.
Hook Block (3-Sheave)	360 Lbs.
Hook Block (4-Sheave)	427 Lbs.

CRANE WORKING POSITIONS

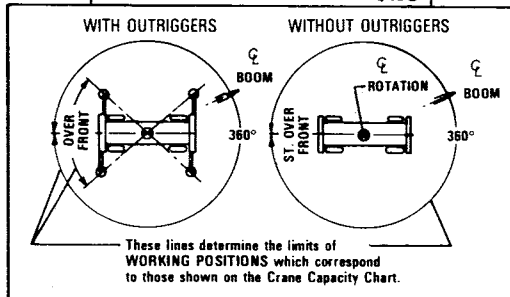

Range Diagram (30'-94' boom)

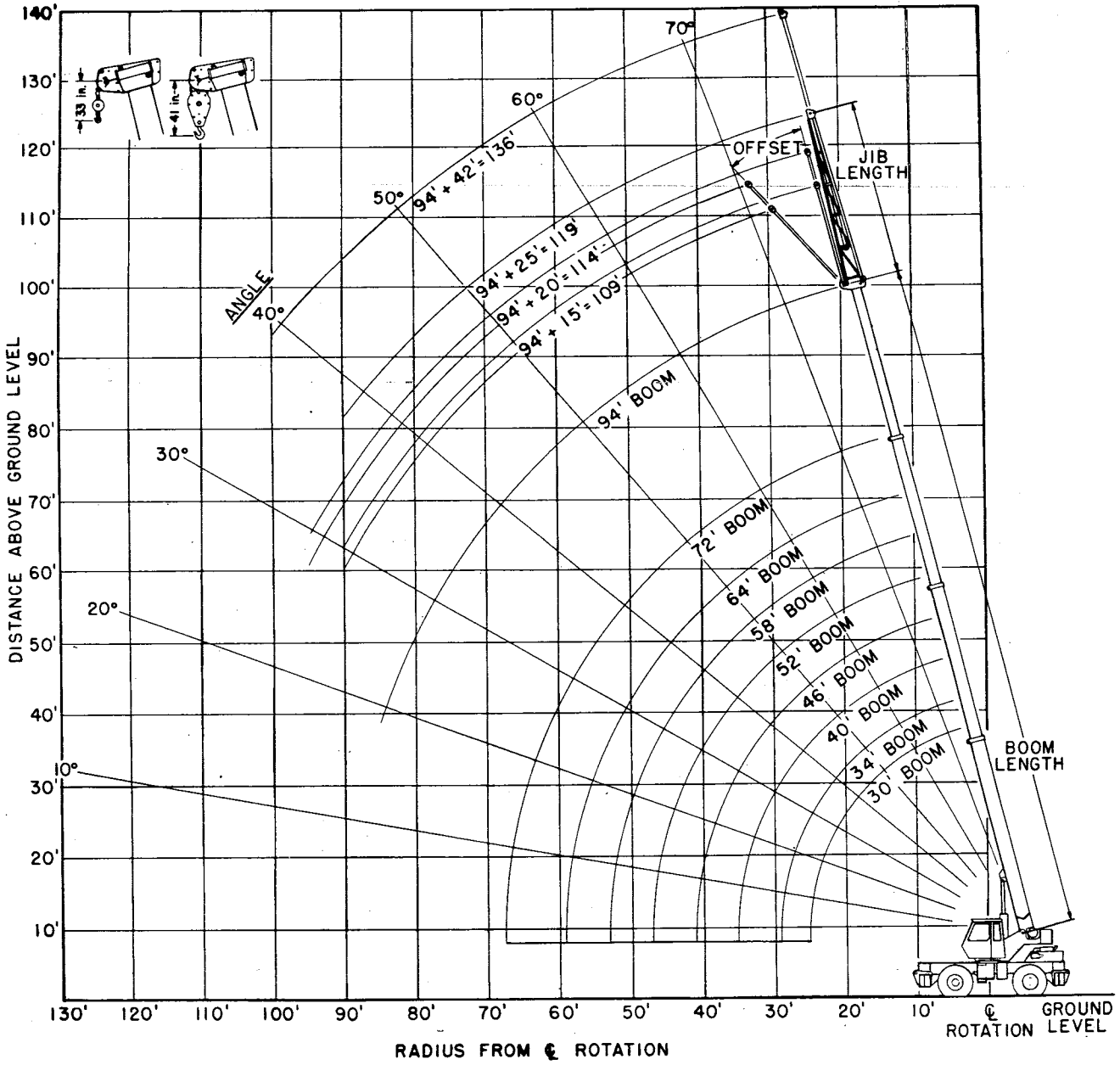



Capacity Charts — Pounds

ON OUTRIGGERS

R A D I U S	BOOM LENGTH 30 ft.		BOOM LENGTH 34 ft.		BOOM LENGTH 40 ft.		BOOM LENGTH 46 ft.		BOOM LENGTH 52 ft.		BOOM LENGTH 58 ft.		BOOM LENGTH 64 ft.		BOOM LENGTH 72 ft.		BOOM LENGTH 94 ft. (1)		R A D I U S			
	Front	360°	Front	360°	Front	360°	Front	360°	Front	360°	Front	360°	Front	360°	Front	360°	Front	360°				
10	65	46,000*	46,000*	68	46,000*	46,000*	72	46,000*	46,000*	75	44,500*	44,500*							10			
12	61	44,800*	44,800*	65	43,300*	43,300*	69	41,300*	41,300*	72	39,800*	39,800*	75	38,600*	38,600*				12			
15	54	36,900*	36,900*	59	37,000*	37,000*	64	35,900*	35,900*	68	34,500*	34,500*	71	33,300*	33,300*	73	32,400*	32,400*	15			
20	40	26,000*	26,000*	47	26,100*	26,100*	56	26,300*	26,300*	61	26,400*	26,400*	65	26,400*	26,400*	68	26,400*	26,400*	20			
25	16	19,300*	19,300*	33	19,500*	19,500*	46	19,700*	19,700*	53	19,800*	19,800*	59	19,900*	19,900*	63	19,900*	19,900*	25			
30							34	15,300*	15,300*	45	15,400*	15,400*	52	15,500*	15,500*	57	15,500*	15,500*	30			
35							11	12,000*	11,300*	34	12,300*	11,600*	45	12,300*	11,700*	51	12,400*	11,800*	35			
40										18	9,800*	8,700*	35	10,000*	8,900*	44	10,000*	8,900*	40			
45													22	8,100*	6,800*	35	8,200*	6,900*	45			
50														24	6,500*	5,400*	36	6,500*	5,400*	50		
55																25	5,200*	4,200*	55			
60																	31	4,200*	3,300*	60		
65																	21	3,300*	2,500*	65		
70																		42	3,700*	3,000*	70	
75																			37	3,000*	2,400*	75
80																			31	2,500*	1,900*	80
85																			22	2,000*	1,500*	85

(1) For boom lengths less than maximum with the pull-out 4th section extended, the rated loads are determined by boom angle only in the 94 ft. Boom Length column. For boom angles not shown, use the capacity of the next lower boom angle.

ON TIRES

R A D I U S	M A X. Δ	M I N. Δ	16.00 x 25 - 24 P.R.				20.5 x 25 - 24 P.R.				R A D I U S
			STATIONARY		PICK & CARRY		STATIONARY		PICK & CARRY		
			360°	ST. OVER FRONT	CREEP	2.5 MPH	360°	ST. OVER FRONT	CREEP	2.5 MPH	
10	67	67	21,100	41,000	33,600*	24,000*	21,300	34,800*	26,800*	18,200*	10
12	64	64	16,400	31,300	29,000*	20,500*	16,500	30,100*	23,000*	15,400*	12
15	58	56	10,800	20,700	20,700	16,500*	10,900	29,900	18,600*	12,100*	15
20	50	42	6,300	12,400	12,400	11,900*	6,900	12,600	12,600	8,400*	20
25	47	19	3,600	8,000	8,000	8,000	4,100	8,200	8,200	5,700*	25
30	45	0	2,000	5,400	5,400	5,400	2,300	5,600	5,600	4,000*	30
35	42	0		3,800	3,800	3,800		4,000	4,000	2,800*	35
40	40	0		2,500	2,500	2,500		2,700	2,700	1,800*	40
45	38	0		1,700	1,700	1,700		1,600	1,600		45

Notes for On Tire Capacities:

- A. For Pick and Carry operation, boom must be centered over the front of the crane with swing brake locked or with mechanical swing lock engaged if crane is so equipped.
- B. The load should be restrained from swinging.
- C. Without outriggers never maneuver the boom beyond listed load radii for applicable tires used to ensure stability.
- D. Creep speed is crane movement of less than 200 ft. (61 m) in a 30 minute period and not exceeding 1.0 mph (1.6 km/h).
- E. Refer to General Notes for additional information.

RECOMMENDED TIRE PRESSURES

	STATIONARY	CREEP	2-1/2 MPH	TRAVEL
16.00x25-24 P.R.	115 PSI	115 PSI	95 PSI	80 PSI
20.50x25-24 P.R.	80 PSI	80 PSI	65 PSI	65 PSI

MAX. PERMISSIBLE HOIST LINE LOAD

LINE PARTS	1	2	3	4	5	6	7
MAX. LOAD	7,600	15,200	22,800	30,400	38,000	45,600	46,000
BOOM HEAD	2	2-D	2-3	1-2-D	1-2-3	1-2-3-D	1-2-3-4
HOOK BLOCK	D	2	2-D	1-2	1-2-D	1-2-3	1-2-3-D
WIRE ROPE:	6x19 or 6x37 Class, 26,600 lbs. Min. Breaking Strength 1/2" Diameter, X.I.P.S., I.W.R.C., Preformed 9/16" Diameter, I.P.S., W.R.C., Preformed 5/8" Diameter, P.S., I.W.R.C., Preformed						

STOW-AWAY JIB

R A D I U S	15 - 20 FT. JIB						R A D I U S
	15 FT. LENGTH			20 FT. LENGTH			
	No Offset	24° Offset	24° Offset	No Offset	24° Offset	24° Offset	
30	75	6000*					30
35	73	6000*	75	6000*	74	6000*	35
40	70	6000*	72	6000*	71	6000*	40
45	67	6000*	69	5700*	68	6000*	45
50	64	6000*	66	5400*	65	6000*	50
55	61	5600	63	5200*	62	5800*	55
60	58	4600	60	4900	59	4800	60
65	55	3800	56	4100	56	4000	65
70	51	3200	53	3400	53	3400	70
75	47	2600	49	2800	50	2800	75
80	43	2100	45	2300	46	2300	80
85	39	1700	40	1800	42	1900	85
90	35	1300	35	1400	38	1500	90
95					34	1200	95

Notes for Jib Capacities:

- F. For all boom lengths less than the maximum with a jib erected, the rated loads are determined by boom angle only in the appropriate column.
- G. For boom angles not shown, use the capacity of the next lower boom angle.
- H. Listed radii are for fully extended main boom only.

SIDE-STOW JIB

R A D I U S	25 FT. & 25-42 FT. JIB				R A D I U S
	25 ft. Length	25 ft. Length	42 ft. Length	42 ft. Length	
30	75	10,000*			30
35	73	8600*	75	4800*	35
40	71	7600*	74	4600*	40
45	69	6700*	72	4300*	45
50	66	6000*	70	4080*	50
55	63	5300*	67	3900*	55
60	60	4700	65	3700*	60
65	57	3900	63	3500*	65
70	54	3200	60	3300*	70
75	51	2600	58	3200*	75
80	48	2100	55	2900	80
85	45	1700	52	2400	85
90	41	1300	49	2000	90
95			46	1600	95
100			43	1300	100

REDUCTION IN MAIN BOOM CAPACITY

All Jibs in Stowed Position	0 Lbs.
15'-20' Stowaway Jib Erected	950 Lbs.
25' Side Stow Jib, Erected	1,850 Lbs.
42' Side Stow Jib, Erected	2,210 Lbs.
Aux. Boom Head Sheave	100 Lbs.

HOOK BLOCK WEIGHTS

Hook & Ball	121 Lbs.
Hook Block (2-Sheave)	330 Lbs.
Hook Block (3-Sheave)	360 Lbs.
Hook Block (4-Sheave)	427 Lbs.

CRANE WORKING POSITIONS

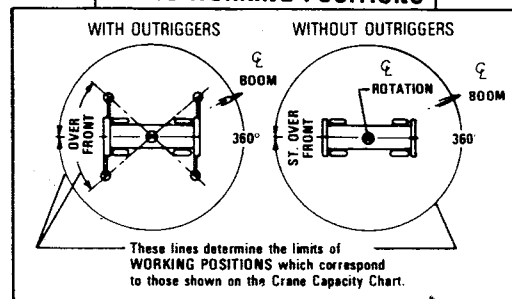

General Notes

GENERAL

1. Review Page 3—21 of Section 3 of the Operator's Manual prior to operating this crane.
2. Crane load ratings as determined by boom length, radius and boom angle apply to this crane only as originally manufactured and equipped. THEY ARE MAXIMUM LOAD RATINGS.
3. This crane and its load ratings are in accordance with Power Crane & Shovel Association Standard No. 4, SAE Crane Load Stability Test Code J-765a, SAE Method of Test for Crane Structure J-1063, and Safety Code for Cranes, Derricks and Hoists, ANSI B30.15-1973.
4. Improperly operated or maintained equipment can be dangerous. The operator and other personnel should read and fully understand the Operator's Manual furnished by the manufacturer before operating or maintaining this machine. Rules for safe operation of equipment should be adhered to at all times. If either Manual or a lift chart are missing, these should be ordered by machine serial number through the distributor.
5. Operators and supervisors must fully understand Safety Standards for Mobile Hydraulic Cranes ANSI B30.15 or latest, and be familiar with Federal, State and local safety regulations.

SET-UP

6. Crane load ratings are based on the machine being leveled and standing on a firm, uniform supporting surface.
7. Crane load ratings on outriggers are based on all outrigger beams fully extended and the tires being raised free of the supporting surface.
8. Crane load ratings on tires depend on appropriate inflation pressure and tire conditions. Caution must be exercised when increasing air pressure in tires. Consult Operator's Manual for precautions.
9. Use of jibs, lattice-type boom extension, or fourth section pull-out extended is not permitted for pick and carry operations.
10. Consult appropriate section of Operator's Manual for more exact description of hoist line reeving.
11. The use of more parts of line than required by the load may result in having insufficient rope to allow the hook block to reach the ground.
12. Properly maintained wire rope is essential to safe crane operation. Consult Operator's Manual for proper maintenance and inspection requirements.
13. When spin-resistant wire rope is used, the allowable rope loading shall be the breaking strength divided by five (5), unless otherwise specified by the wire rope manufacturer.

OPERATION

14. Crane load ratings must not be exceeded. DO NOT ATTEMPT TO TIP THE MACHINE TO DETERMINE ALLOWABLE LOADS.

15. Crane load ratings are for lift crane service. Applications other than lift crane (clamshell and magnet) are permitted. Due to significant variation in materials and applications, consult factory for optimum capacity.
16. Weight of hooks, hook blocks, slings and all other load handling devices must be considered part of the load to be handled and must be subtracted from the load ratings to obtain the allowable load to be lifted.
17. Crane load ratings are based on freely suspended loads. SIDE LOAD ON BOOM OR JIB IS EXTREMELY DANGEROUS.
18. Practical working loads depend on the supporting surface, wind velocity, pendulum action, jerking or sudden stopping of loads, hazardous surroundings, experience of personnel and proper operation, tire inflation, tire condition, traveling with loads, multiple machine lifts, proximity of electrical wires, etc. Appropriate reduction of load ratings must be made for these and any other conditions which may effect practical working loads.
19. Crane load ratings with an asterisk (*) beside them are based on the machine's structural strength. All other ratings are based on stability and do not exceed the specified percentage of tipping load as determined by SAE Crane Stability Test Code J-765a.
20. When either radius or boom length or both are between listed values, the smaller of the two load ratings shall be used.
21. Do not operate at longer radii than those listed on the applicable load rating chart as tipping can occur without a load on the hook.
22. Power telescoping boom sections must be extended equally.
23. Load ratings are dependent upon the crane being maintained according to manufacturer's specifications.
24. The maximum load which may be telescoped is limited by boom angle, hydraulic pressure, boom lubrication, etc. It is safe to attempt to extend and retract within the limits of the capacity chart.
25. It is recommended that load handling devices, including hooks and hook blocks, be kept away from boom head at all times.
26. The boom angles shown on the capacity chart give an approximation of the operating radius for a specified boom length. The boom angle before loading should be greater to account for boom deflection.

DEFINITIONS

27. Operating radius: The horizontal distance from the axis of rotation before loading to the center of the vertical hoist line or tackle with load applied.
28. Freely suspended load: Load hanging free with no direct external force applied except by the hoist rope.
29. Side Load: Horizontal force applied to the lifted load either on the ground or in the air.
30. Working Area: Areas measured in a circular arc around the centerline of rotation as shown on the working area diagram.

— Notes —

Lined area for notes, consisting of approximately 25 horizontal lines.

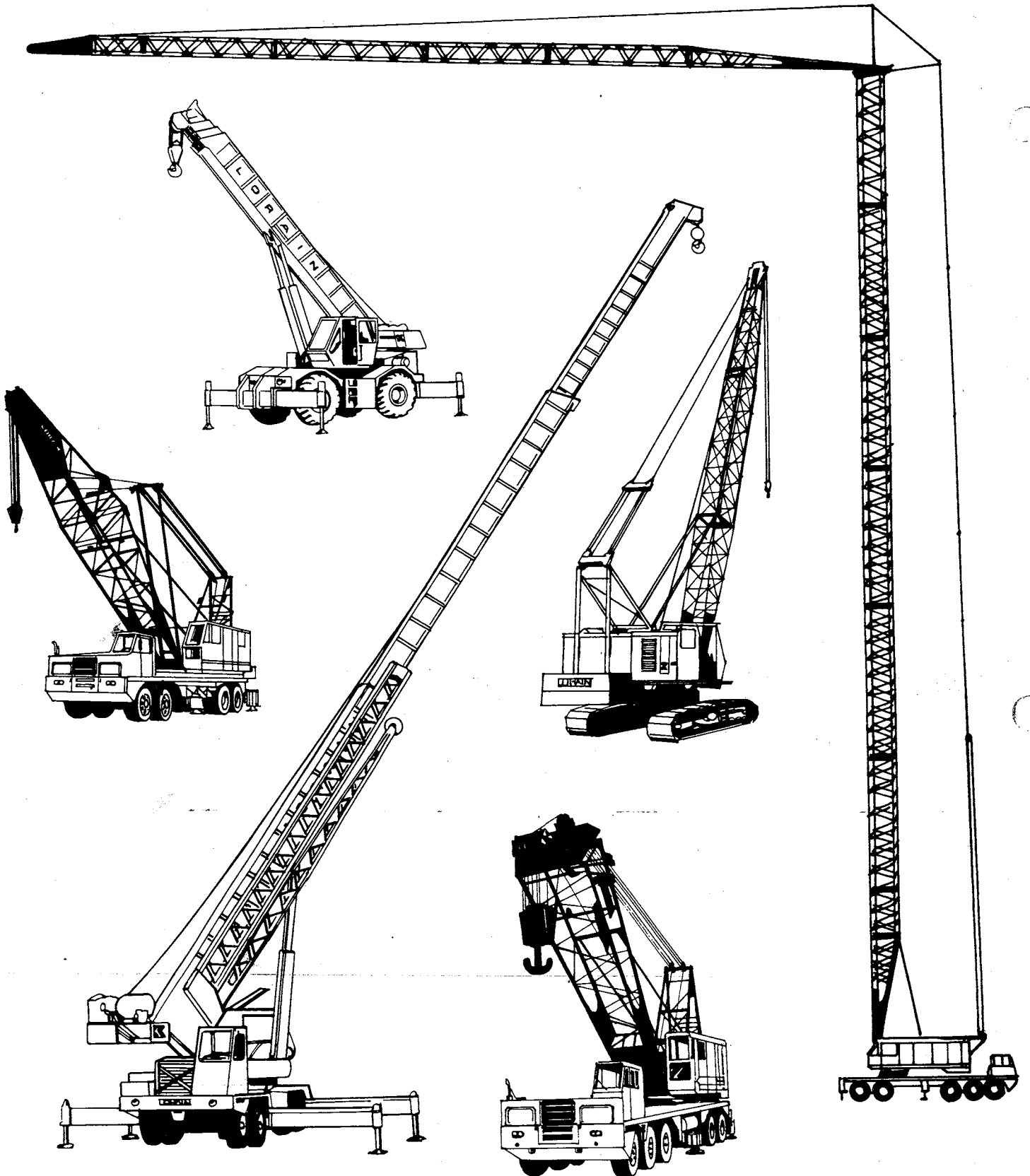

WE RESERVE THE RIGHT TO AMEND THESE SPECIFICATIONS AT ANY TIME WITHOUT NOTICE. THE ONLY WARRANTY APPLICABLE IS OUR STANDARD WRITTEN WARRANTY APPLICABLE TO THE PARTICULAR PRODUCT AND SALE. WE MAKE NO OTHER WARRANTY, EXPRESSED OR IMPLIED.



**KOEHRING CRANES
& EXCAVATORS**

ANCA
INTERNATIONAL