

HYDRAULIC CRAWLER CRANE

KOBELCO

7350

Max. Lifting Capacity (Heavy-duty) : 350 tons at 6.0 m
Max. Boom Length (Light-duty) : 96 m
Max. Lifting Capacity (Luffing Jib) : 113.5 tons at 16.0 m
Max. Combination (Boom + Jib Length) : 72 m + 54 m

Specifications

Versatility of the Boom and Jib

Boom, jib and minimal attachment changeover requirements accommodate many operating configurations ranging from heavy-duty to luffing tower applications.

Superior Hydraulic Technology

Superior hydraulic technology improves operating efficiency and safety. The high-speed winch provides fast 130m/min hoisting and lowering, and a shockless control system enhances safety in hoisting and lowering the hook and boom.

Translifter (Self-Erection System)

Use the built-in, remote controlled Translifter (jack system) to lift the machine clear of the trailer, then drive the trailer away.

Easy Transportation

The main body breaks down into 4 components, each overall width is within 3.0 m. This enables the machine with axles to be transported on a trailer.

General Dimensions

Unit: mm

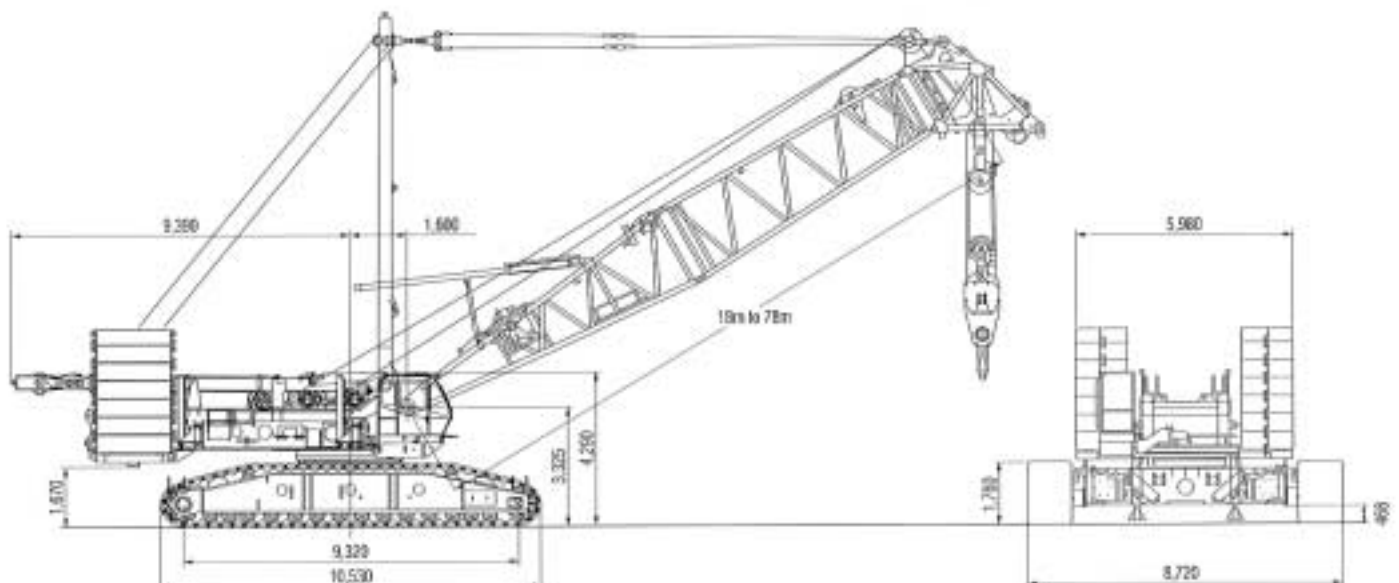

Configuration and Style of Attachment

Style and Combination of Boom and Jib

Style	Heavy-duty Crane	HL Crane	SHL Crane	Light-duty Crane	Luffing Jib	HL Luffing Jib	SHL Luffing Jib
Specifications							
Max. lifting capacity	350 t x 6.0 m	350 t x 7.0 m	350 t x 10.0 m	113.5 t x 14.0 m	113.5 t x 16.0 m	113.5 t x 18.0 m	113.5 t x 16.0 m
Basic boom length	18 m	30 m	30 m	30 m	24 m + 24 m	30 m + 24 m	30 m + 24 m
Max. boom length	78 m	78 m	78 m	96 m	72 m + 54 m	72 m + 66 m	78 m + 66 m
Crane Boom/Main Boom for Luffing Jib							
Lower boom-Mast	Common use (1)	Common use (1)	Common use (1)	Common use (1)	Common use (1)	Common use (1)	Common use (1)
Boom cap	Common use (1)	Common use (1)	Common use (1)	N.A.	Common use (1)	Common use (1)	Common use (1)
6 m insert boom: A	Common use (2)	Common use (2)	Common use (2)	Common use (2)	Common use (1)	Common use (1)	Common use (2)
12 m insert boom: C	Common use (4)	Common use (4)	Common use (4)	Common use (4)	Common use (4)	Common use (4)	Common use (4)
6 m tapered boom: D	N.A.	N.A.	N.A.	Common use (1)	N.A.	N.A.	N.A.
7.8 m tapered boom: B	Common use (1)	Common use (1)	N.A.	Common use (1)	Common use (1)	Common use (1)	Common use (1)
Luffing Jib							
Lower jib	N.A.	N.A.	N.A.	N.A.	Common use (1)	Common use (1)	Common use (1)
Light-duty jib	N.A.	N.A.	N.A.	Common use (1)	Common use (1)	Common use (1)	Common use (1)
6m insert jib: E	N.A.	N.A.	N.A.	Common use (1)	Common use (1)	Common use (1)	Common use (1)
12 m insert jib: F	N.A.	N.A.	N.A.	Common use (1)	Common use (3)	Common use (1)	Common use (1)

Note:

1. Figure in () means the numbers of the maximum usable boom (or jib) respectively.
2. N.A.: Not applicable

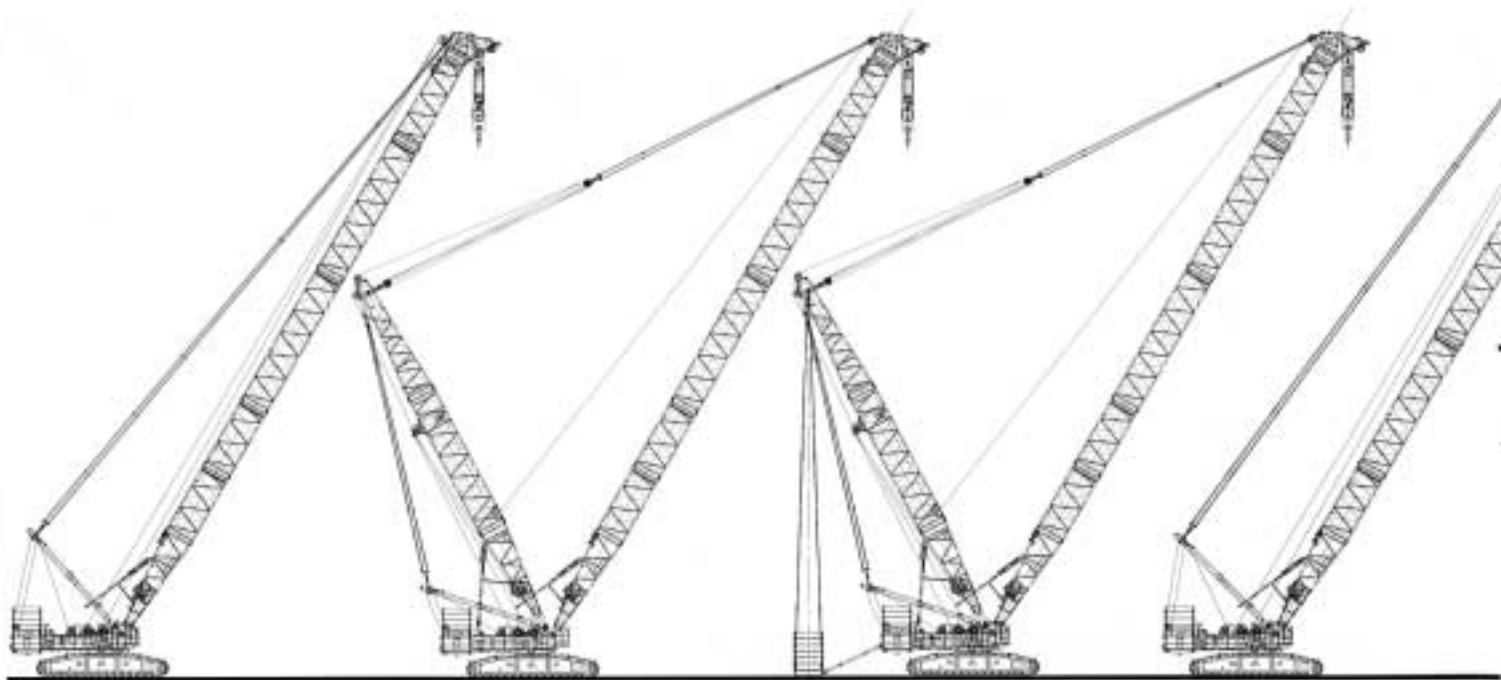

Standard Crane

Max. Lifting Capacity:
350 metric ton x 6.0 m
 Boom Length:
18m to 78m

HL Crane

Max. Lifting Capacity:
350 metric ton x 7.0 m
 Boom Length:
30m to 78m

SHL Crane

Max. Lifting Capacity:
350 metric ton x 10.0 m
 Boom Length:
30m to 78m

Light-duty Crane

Max. Lifting Capacity:
113.5 metric ton x 14.0 m
 Boom Length:
30m to 96m



Luffing Jib

Max. Lifting Capacity:
113.5 metric ton x 16.0 m
Boom + Jib Length:
24m + 24m to 72m + 54m

HL Luffing Jib

Max. Lifting Capacity:
113.5 metric ton x 16.0 m
Boom + Jib Length:
30m + 24m to 72m + 66m

SHL Luffing Jib

Max. Lifting Capacity:
113.5 metric ton x 16.0 m
Boom + Jib Length:
30m + 24m to 78m + 66m

Specifications

Upper machinery



Power plant

Model HINO K13C-UV*

Type Water-cooled, direct injection with turbocharger, diesel

No. of cylinders 6

Bore and stroke 135 mm x 150 mm

Displacement 12.882 liters

Rated power (Gross) 295 kW at 2,000 min⁻¹ (ISO09249-1989)

Max. torque (Gross) 1,610 N·m at 1,400 min⁻¹ (ISO09249-1989)

Cooling system Liquid, recirculating bypass

Starter 24 V, 7.0 kW

Generator 24 V, 80 A

Cycles 4

Radiator Corrugated type core, thermostatically controlled

Air cleaner Dry type with replaceable paper element

Fuel tank capacity 600 liters

Batteries Two 12V, 150 A-hr capacity batteries, series connected

Filtration Full flow and by-pass type with replaceable paper element

Electrical system All wiring corded for easy servicing, individual fused branch circuits.

*Meet Stage II refers to European standards. Stage II emissions requirements.



Hydraulic system

Pumps: All five pumps are driven by heavy duty pump drive. Three tandem variable displacement pumps are used. One of tandem variable displacement pumps is used in the front and rear hoist drum circuit and the propel circuit. One of other tandem variable displacement pumps is used in boom hoist circuit and swing circuit. Another one of tandem variable displacement pumps is used in jib hoist circuit. In addition two gear pumps are used in the control system and auxiliary equipment.

Control:

Hydraulic control system for infinitely variable pressure to front and rear drums, boom and jib hoist drums.

Controls respond instantly to the touch, delivering smooth function operation. Pumped fluid is filtered before returning to pump.

Pressure:

Load hoist, boom hoist

and propel system 31.9 MPa (325 kgf/cm²)

Swing system 27.5 MPa (280 kgf/cm²)

Control system 5.4 MPa (55 kgf/cm²)

Reservoir tank capacity 870 liters

Cooling Oil-to-air heat exchanger

Filtration Full flow filters with replaceable paper elements



Load hoist system

Front and rear drum for load hoist powered by one hydraulic axial piston motors, each through planetary reducers.

Brakes: Hydraulic counterbalance valve mounted on jib

hoist motor and disc type brake, spring set hydraulically release brake and release safety pawl.

Drums (Front and Rear): 630 mm P.C.D. x 1,019 mm wide drums, each grooved for 28 mm wire rope.

Rope capacity of 670 m working length and 800 m storage length.

Line speed: Single line on the first drum layer

Hook hoist (Front drum)

Hoisting 3 to 130 m/min

Lowering 3 to 130 m/min

Hook hoist (Rear drum)

Hoisting 3 to 130 m/min



Boom hoist system

Powered by a hydraulic axial piston motor through a planetary reducer.

Brakes: Hydraulic counterbalance valve and spring set hydraulically released multiple disc brake mounted on boom hoist motor. Externally ratchet for locking drum.

Drum:

Boom hoist drum: Double drums, grooved for 26 mm dia. wire rope.

Jib hoist drum: Grooved for 26 mm dia. wire rope.

Line Speed: Single line on fifth drum layer

Boom hoist

Hoisting 2 to 22 m/min

Lowering 2 to 22 m/min

Luffing jib hoist

Hoisting 2 to 28 m/min

Lowering 2 to 28 m/min



Jib and mast hoist system (for HL and SHL)

Powered by a hydraulic axial piston motor through a planetary reducer.

Brakes: Hydraulic counterbalance valve and spring set hydraulically released multiple disc brake mounted on boom hoist motor. Externally ratchet for locking drum.

Drum: Grooved for 26 mm dia. wire rope.

Line Speed:

Hoisting 2 to 28 m/min

Lowering 2 to 28 m/min



Swing system

Swing unit: Powered by hydraulic axial piston motor driving through planetary reducers (3 sets), the swing system provides 360° rotation.

Swing speed 1.3 min⁻¹

Swing brake: A spring-set, hydraulically released multiple-disc brake mounted on swing motor.

Swing circle: Triple row roller bearing with an internal, integral swing gear.

Swing lock: Four-position pin-in-hole lock (manually engaged)



Operator's cab

Independent removable RH cab tilts 15°. Full-vision cab fitted with safety glass, a fixed front window, and sliding LH/RH windows. A fully adjustable, high-backed seat with a head rest permits the operator to set ideal working position. A signal horn, cigarette lighter, windshield wipers, washers, and floor mat are standard features.



Controls

At operator's right are console mounted adjustable short levers for front and rear drum controls, and boom hoist control. At the operator's left are console-mounted swing control lever, knobs for front and rear drum, boom drum pawls, engine start/stop key, individual speed shifts for front drum, rear drum, boom drum, swing and propel, swing mode switch. Swing brake control switch and signal horn button are on swing lever.

Lights: One front flood light and one cab inside light

Multi-display Monitor

Gauges and warning signs shown on Multi-display monitor

Gauges: Tachometer, hour meter, fuel gauge

Warning signs: Battery charge, engine oil pressure, air cleaner, engine oil filter, control main pressure, and hydraulic oil temperature



Safety devices:

Over load protective device (Moment limiter), function lock lever, hook over hoist shut off, boom over-hoist limit, boom angle indicator, signal horn, boom hoist drum lock, front and rear drum lock, swing lock, swing alarm (buzzer), lamp for front, warning buzzer for swing and propel, auxiliary platform (upper and lower structure), boom backstops, jib backstops, strut backstops



Tools

A set of standard tools and accessories are furnished.



Mast construction:

Welded construction using high-tensile steel chords and should be attached to the mast foot on the front side of the revolving frame. The mast is necessary regardless of the boom length.

Counterweight

11-piece stack
Total weight 120,000 kg

Additional counterweight
Weight 35,000 kg

Carbody counterweight
2-piece stack
Total weight 41,000 kg

Pallet (Lift enhancer)
Weight 250,000 kg (max.)

Trans-Lifter

Trans-Lifter system allows quick and easy crawler side frame removal and trailer loading. Four vertical cylinders lift up the basic machine for self-loading onto trailer.



Optional equipment

Reeving winch (with 8 mm dia x 350 m wire rope), air-conditioner, TV monitor for lifting load, one way call, mirror for monitoring drum, wind velocity indicator, level indicator for crane body, monitoring TV for front and rear drum, boom foot pin cylinder, crawler frame installation cylinder, lower translifter cylinder, pads for raising boom, anemometer, exterior indication light for loading condition, front and rear hoist drum rotation indicator, sling materials for assembling and disassembling, foot step for boom and jib, hand rail for boom and jib

Lower machinery

Carbody: Steel-welded carbody with axles.

Crawler: Crawler assemblies designed with a quick disconnect feature for individual removal as a unit from the axles. Crawler belt tension is maintained by hydraulic jack force on the track-adjusting bearing block. Track rollers are sealed for maintenance-free operation.

Crawler drive: Independent hydraulic propel drive is built into each side frame. Each drive consists of a hydraulic motor propelling a driving tumbler through a planetary gear box. Hydraulic motor and gear box are built into the crawler side frame.

Crawler brakes: Spring-set, hydraulically released multiple-disc parking brakes are built into each propel drive.

Steering mechanism: The hydraulic propel system provides both skid steering (driving one track only) and counter-rotating steering (driving tracks in opposite directions).

Track rollers: 14 lower rollers and 2 upper rollers are fitted to each side frame, sealed and maintenance-free.

Shoes:
Number 67 each side
Standard flat shoe width 1,220 mm

Max. travel speed:
High range 1.0 km/h
Low range 0.4 km/h

Max. gradeability: 30%



Weight

Operating weight:

Approx. 345,000 kg
(including base machine, 120 t counterweights, 41 t carbody weights, 18 m heavy-duty boom and 350-ton hook block)

Ground pressure: 15 N/cm² (1.52 kgf/cm²),
150 kPa with 1,220 mm shoes



Boom:

Welded lattice construction using tubular, high-tensile steel chords with pin connections between sections.

Standard Crane

Max. lifting capacity	350,000 kg at 5 m
Basic boom length	18 m
Max. boom length	78 m

Basic boom 9 m
 Tapered boom insert 7.8 m
 Boom cap 1.2 m
 No. of point sheave 9 + (8)*
 *: with additional 2-step sheave

HL Crane

Max. lifting capacity	350,000 kg at 7 m
Basic boom length	30 m
Max. boom length	78 m

Basic boom 9 m
 Tapered boom insert 7.8 m
 Boom cap 1.2 m
 Mast 30 m
 No. of point sheave 9 + (8)*
 *: with additional 2-step sheave

SHL Crane

Max. lifting capacity	350,000 kg at 14 m
Basic boom length	30 m
Max. boom length	78 m

Basic boom 9 m
 Tapered boom insert 7.8 m
 Boom cap 1.2 m
 Mast 30 m
 No. of point sheave 9 + (8)*
 Weight of palette Max. 250 tons
 Position of palette 13 m
 (from the center of rotation behind the crane)
 *: with additional 2-step sheave

Light-duty Crane

Max. lifting capacity	113,500 kg at 14 m
Basic boom length	30 m
Max. boom length	96 m

Basic boom 9 m
 Tapered boom insert 6 m
 Boom cap 9 m
 No. of point sheave 5



Hook blocks

A range of hook blocks can be specified, with a safety latch.

Lifting capacity	350 ton	200 ton	120 ton
No. of sheaves	9 + (8)	9	5
Weight (kg)	8,735	6,050	3,500

Lifting capacity	70 ton	40 ton	13.5 ton ball hook
No. of sheaves	3	1	0
Weight (kg)	3,100	2,000	650

Diameter of wire ropes

Standard:

Hook hoist (Front) 28 mm
 Hook hoist (Rear) 28 mm
 Boom hoist (32 parts of line reeving) 26 mm
 Boom guy line (4 lines) 44 mm

Boom backstops

Required for all boom lengths.



Weight

Standard Crane

Operating weight:

Approx. 350,000 kg
 (including base machine, 120 t counterweights, 41 t carbody weights, 18 m heavy-duty boom and 350-ton hook block)

Ground pressure: 15 N/cm² (1.52 kgf/cm²),
 150 kPa with 1,220 mm shoes

HL Crane

Operating weight:

Approx. 370,000 kg
 (including base machine, 120 t counterweights, 41 t carbody weights, 30 m heavy-duty boom and 350-ton hook block)

Ground pressure: 16 N/cm² (1.63 kgf/cm²),
 160 kPa with 1,220 mm shoes

SHL Crane

Operating weight:

Approx. 370,000 kg
 (including base machine, 120 t counterweights, 41 t carbody weights, 30 m heavy-duty boom and 350-ton hook block)

Ground pressure: 16 N/cm² (1.63 kgf/cm²),
 160 kPa with 1,220 mm shoes

Light-duty Crane

Operating weight:

Approx. 339,000 kg
 (including base machine, 120 t counterweights, 41 t carbody weights, 30 m heavy-duty boom and 120-ton hook block)

Ground pressure: 15 N/cm² (1.5 kgf/cm²),
 150 kPa with 1,220 mm shoes

Notes:

1. Operating radius is the horizontal distance from the center of rotation to the center of gravity of the load.
2. Rated loads shown on the charts are the maximum allowable freely suspended loads at a given boom length, boom angle and radius, and have been determined for the machine standing level on firm supporting surface under ideal operating conditions. The user must limit or de-rate loads to allow for adverse conditions (such as soft or uneven ground, out-of-level conditions, winds, side loads, pendulum action, jerking or sudden stopping of loads, inexperience of personnel, multiple machine lifts, and traveling with a load).
3. Capacities do not exceed 75% of minimum tipping loads. Capacities based on factors other than machine stability such as structural competence are indicated by shaded area. Attempt to over load could damage the boom, jib and frame, etc. without tipping.
4. The rated loads are determined in accordance with ANSI Code B30.5.
5. Areas on rated charts where no rating are shown, operation is not intended or approved.
6. Actual allowable loads of crane boom must not exceed either the maximum load at the each number of reeving mentioned in the following article 8, or the rated loads for the boom length. Actual hoistable loads using the crane boom are determined by deducting the weight of the load handling gear (such as hook block, slings and cables) from the ratings and should not exceed the ratings of the hook block.
7. For configurations of insert booms and guy cable assembly, instructions in the operator's manual must be strictly observed.
8. Max. hoisting load by number of reeving

Single Drum

No. of hoist reeving	1	2	3	4	5	6	7	8
Max. load (ton)	13.5	27.0	40.0	53.0	65.5	78.0	90.0	101.5
No. of hoist reeving	9	10	11	12	13	14	16	18
Max. load (ton)	113.5	124.5	136.0	147.0	157.5	168.0	178.5	200

Double Drum

No. of hoist reeving	6 x 2	8 x 2	10 x 2
Max. load (ton)	156.0	203.5	249.5
No. of hoist reeving	12 x 2	14 x 2	16 x 2
Max. load (ton)	294	336.0	360.0

9. An auxiliary sheave can be fitted to Std crane of 18 m to 78 m, and light-duty lift of 30 m to 96 m.
10. Rated loads for auxiliary sheave are determined by deducting the auxiliary sheave weight (150 kg for Std crane; 550 kg for light-duty lift) and weight of hook block (650 kg) and load handling gear (sling and cables) from crane boom ratings, but must not exceed a maximum 13.5 ton.
11. The maximum operating radius of an auxiliary sheave must not exceed the maximum operating radius of the crane boom in use. The minimum operating radius of an auxiliary sheave is determined by the equivalent boom angle at the minimum operating radius.
12. Rated loads for the crane boom with an auxiliary sheave attached are determined by deducting the auxiliary sheave weight from crane boom ratings. Where a 13.5-ton ball hook is fitted, the weight of the hook must also be deducted.
13. Actual allowable loads of the crane boom when an auxiliary sheave is attached are determined by deducting the weight of the load handling gear (such as the main hook, slings and cables) from the ratings so determined in the article 11.
14. Do not operate the main hook and auxiliary sheave hook simultaneously.
15. Refer to the operator's manual for appropriate type of hook block and number of reeving at each boom length.
16. When using a light-duty boom of over 84 m, an intermediate suspension cable must be used.
17. Always have the gantry fully raised and use the backstop during crane operations.
18. Boom hoist reeving must be twenty parts of line.
19. In principle, the boom should be erected over the front of the crawlers.

The following conditions should be observed:

Boom	Std Crane	HL Crane	SHL Crane	Light-duty Crane
Counterweight	120	120	120	120
Carbody weight	41	41	41	41
Pillow plates (over the front)	No need	No need	No need	No need

Standard Crane Rated Chart

7350
MasterTech

Rated loads in metric tons for 360° working area

(Counterweight 120 tons + Carbodyweight 41 tons, Double drum)

Unit: metric tons

Boom length (m) Operating radius (m)	18.0	24.0	30.0	36.0	42.0	48.0	54.0	60.0	66.0	72.0	78.0	Boom length (m) Operating radius (m)
5.0	6.0 m/350.0	5.5 m/350.0										5.0
6.0	350.0	350.0	6.1 m/350.0	6.8 m/343.3								6.0
7.0	320.7	318.5	316.8	314.4	7.4 m/302.1							7.0
8.0	289.4	287.0	285.8	283.8	282.2	8.0 m/261.1	8.6 m/242.4					8.0
9.0	231.8	230.4	228.8	226.9	225.3	224.1	222.9	9.3 m/219.7	9.9 m/200.4			9.0
10.0	203.0	202.0	200.5	198.7	197.2	195.9	194.6	193.5	192.5	10.5 m/171.4	11.1 m/144.7	10.0
12.0	160.8	160.8	160.1	158.5	157.0	155.8	154.5	153.3	152.1	151.1	142.5	12.0
14.0	127.2	127.0	126.4	125.5	124.6	124.1	123.8	122.9	122.7	122.7	121.9	14.0
16.0	104.8	104.4	103.5	102.7	101.8	101.1	100.7	99.8	99.5	99.4	98.6	16.0
18.0	17.9 m/89.7	88.2	87.2	86.3	85.2	84.6	84.2	83.2	82.9	82.8	81.9	18.0
20.0		76.0	75.0	74.0	72.8	72.3	71.7	70.8	70.4	70.3	69.3	20.0
22.0		66.6	65.5	64.5	63.3	62.7	62.1	61.1	60.7	60.5	59.6	22.0
24.0		23.1 m/62.3	57.9	56.8	55.6	55.0	54.4	53.3	52.9	52.7	51.8	24.0
26.0			51.8	50.6	49.4	48.7	48.0	47.0	46.8	46.4	45.4	26.0
28.0			47.4	45.5	44.2	43.5	42.8	41.7	41.3	41.1	40.0	28.0
30.0			28.3 m/46.7	41.2	39.9	39.1	38.4	37.3	36.8	36.6	35.5	30.0
34.0				33.5 m/35.3	33.0	32.1	31.3	30.2	29.7	29.4	28.3	34.0
38.0					28.0	26.9	26.0	24.9	24.3	23.9	22.9	38.0
42.0					38.7 m/27.3	22.9	21.9	20.7	20.0	19.6	18.3	42.0
46.0						43.9 m/21.4	18.7	17.4	16.4	15.9	14.5	46.0
50.0							49.1 m/16.7	14.5	13.5	12.8	11.5	50.0
54.0								12.5	11.1	10.3	8.9	54.0
58.0								54.3 m/12.3	9.1	8.2	6.8	58.0
62.0									59.5 m/9.5	6.5	5.0	62.0
66.0										64.7 m/5.6	3.6	66.0
70.0											69.8 m/2.4	70.0
reeves	32	32	32	32	28	24	20	20	16	16	16	reeves

⊞ Designed and rated to comply with ANSI Code B30.5.

Ratings shown in are determined by the strength of the boom or other structural components.

This is the rated for double drum.

Working Ranges

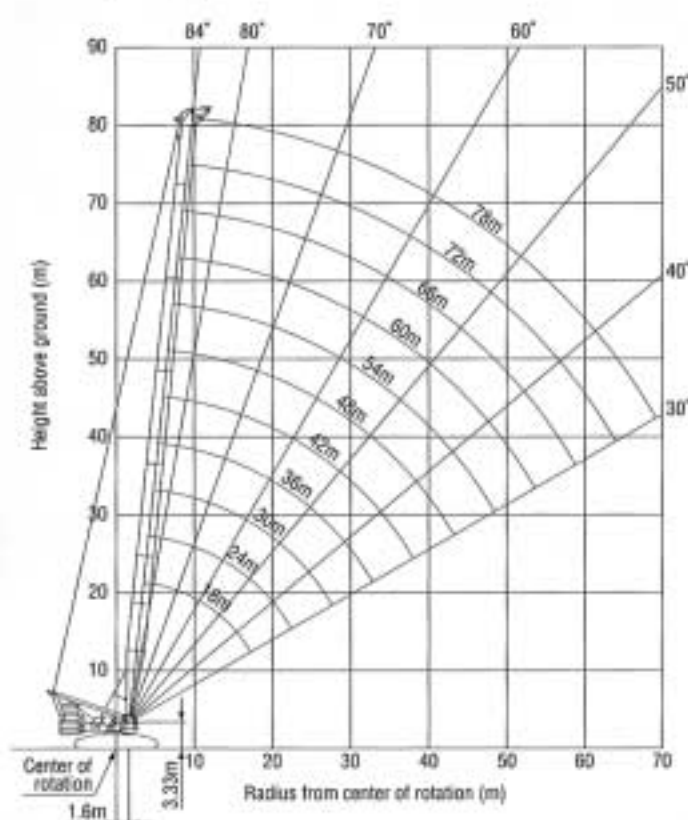

Boom Arrangement

Boom length	Boom arrangement
18 m	Base-B-Cap
24 m	Base-A-B-Cap
30 m	Base-A-A-B-Cap, Base-C-B-Cap
36 m	Base-A-C-B-Cap
42 m	Base-A-A-C-B-Cap, Base-C-C-B-Cap
48 m	Base-A-C-C-B-Cap
54 m	Base-A-A-C-C-B-Cap, Base-C-C-C-B-Cap
60 m	Base-A-C-C-C-B-Cap
66 m	Base-A-A-C-C-C-B-Cap, Base-C-C-C-C-B-Cap
72 m	Base-A-C-C-C-C-B-Cap
78 m	Base-A-A-C-C-C-C-B-Cap

Base = 9.0 m, Cap (Heavy-duty Cap) = 1.2 m,
inserts: A = 6.0 m, B (tapered boom) = 7.8 m, C = 12.0 m

HL Crane Rated Chart

7350
MasterTech

Rated loads in metric tons for 360° working area

(Counterweight 120 tons + 35tons, Carbodyweight 41 tons, Double drum)

Unit: metric tons

Boom length (m) Operating radius (m)	30.0	36.0	42.0	48.0	54.0	60.0	66.0	72.0	78.0	Boom length (m) Operating radius (m)
6.0	6.1 m/350.0	6.6 m/350.0								6.0
7.0	350.0	350.0	7.4 m/350.0							7.0
8.0	315.5	315.0	311.4	306.0	8.6 m/280.0					8.0
9.0	282.4	269.6	269.1	269.1	268.8	9.3 m/249.5	9.7 m/224.0			9.0
10.0	224.2	223.5	223.0	222.8	222.4	222.1	221.8	10.5 m/196.0		10.0
12.0	166.1	165.2	164.6	164.4	163.9	163.5	163.1	162.8		12.0
14.0	131.1	130.2	129.5	129.2	128.8	128.1	127.7	127.3	126.6	14.0
16.0	107.8	106.8	106.0	105.6	105.0	104.5	104.0	103.6	102.8	16.0
18.0	91.1	90.0	89.2	88.7	88.1	87.5	87.0	86.6	85.7	18.0
20.0	78.5	77.4	76.6	76.1	75.4	74.8	74.3	73.8	72.9	20.0
22.0	68.8	67.7	66.8	66.2	65.5	64.9	64.3	63.8	62.9	22.0
24.0	61.1	59.9	59.0	58.4	57.6	57.0	56.4	55.8	55.0	24.0
26.0	54.8	53.6	52.6	51.9	51.2	50.5	49.9	49.3	48.4	26.0
28.0	50.4	48.3	47.3	46.6	45.8	45.1	44.5	43.9	43.0	28.0
30.0	28.3 m/49.7	43.9	42.8	42.1	41.3	40.5	39.9	39.3	38.4	30.0
34.0		33.5 m/38.1	35.8	34.9	34.1	33.3	32.6	32.0	31.0	34.0
38.0			30.6	29.6	28.6	27.8	27.0	26.4	25.4	38.0
42.0			38.7 m/30.1	25.4	24.4	23.5	22.7	22.0	21.0	42.0
46.0				43.9 m/24.0	21.1	20.1	19.2	18.5	17.3	46.0
50.0					49.1 m/19.1	17.3	16.4	15.4	14.2	50.0
54.0						15.3	13.9	12.8	11.6	54.0
58.0						54.3 m/15.1	11.8	10.7	9.4	58.0
62.0							59.5 m/11.3	8.9	7.6	62.0
66.0								64.7 m/ 8.0	6.0	66.0
70.0									69.8 m/ 4.9	70.0
reeves	32	32	32	28	24	20	20	16	16	reeves

■ Designed and rated to comply with ANSI Code B30.5.

Ratings shown in are determined by the strength of the boom or other structural components.

This is the rated for double drum.

Working Ranges

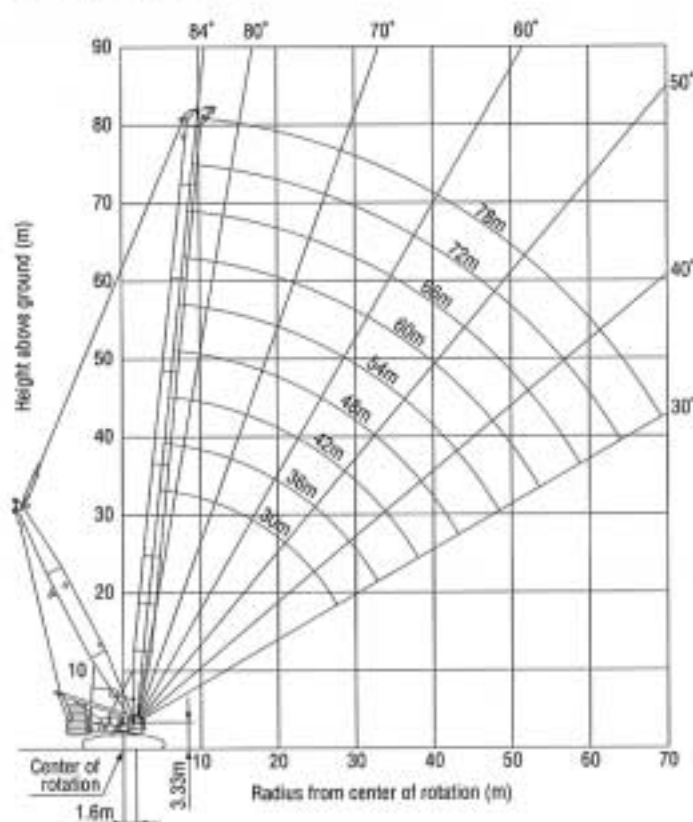

Boom Arrangement

Boom length	Boom arrangement
30 m	Base-A-A-B-Cap, Base-C-B-Cap
36 m	Base-A-C-B-Cap
42 m	Base-A-A-C-B-Cap, Base-C-C-B-Cap
48 m	Base-A-C-C-B-Cap
54 m	Base-A-A-C-C-B-Cap, Base-C-C-C-B-Cap
60 m	Base-A-C-C-C-B-Cap
66 m	Base-A-A-C-C-C-B-Cap, Base-C-C-C-C-B-Cap
72 m	Base-A-C-C-C-C-B-Cap
78 m	Base-A-A-C-C-C-C-B-Cap

Base = 9.0 m, Cap (Heavy-duty Cap) = 1.2 m,
Inserts: A = 6.0 m, B (tapered boom) = 7.8 m, C = 12.0 m

Mast Arrangement

Mast length	Mast arrangement
30 m	Base-C-Tip

Base = 9.0 m, Tip = 9.0 m
Inserts: C = 12.0 m

SHL Crane Rated Chart

7350
MasterTech

Rated loads in metric tons for 360° working area

(Counterweight 120 tons + Carbodyweight 41 tons, Pallette weight 250 tons x 13 m, Double drum) Unit: metric tons

Operating radius (m)	Boom length (m)									Operating radius (m)
	30.0	36.0	42.0	48.0	54.0	60.0	66.0	72.0	78.0	
6.0	6.1 m/350.0	6.8 m/350.0								6.0
7.0	350.0	350.0	7.4 m/350.0							7.0
8.0	350.0	350.0	350.0	308.0	8.6 m/280.0					8.0
9.0	350.0	350.0	350.0	308.0	280.0	9.3 m/249.5	9.7 m/224.0			9.0
10.0	350.0	350.0	349.9	308.0	280.0	249.5	224.0	10.5 m/196.0		10.0
12.0	350.0	350.0	349.2	308.0	280.0	249.5	224.0	196.0		12.0
14.0	336.0	332.5	331.7	308.0	280.0	249.5	224.0	196.0	190.7	14.0
16.0	293.0	293.0	293.0	293.0	280.0	249.5	224.0	196.0	190.3	16.0
18.0	257.1	263.7	260.4	262.9	262.4	249.5	224.0	196.0	189.6	18.0
20.0	217.8	234.6	231.5	233.7	235.8	233.0	221.8	196.0	188.8	20.0
22.0	184.5	214.1	209.1	213.1	212.6	205.7	209.7	196.0	187.8	22.0
24.0	155.1	195.7	191.0	194.5	192.1	187.7	189.3	191.0	186.6	24.0
26.0	128.1	177.1	176.2	175.7	175.2	171.2	172.6	174.0	173.3	26.0
28.0	105.1	154.3	160.7	160.1	159.5	159.0	158.6	158.2	157.5	28.0
30.0	28.3 m/101.7	131.6	147.5	146.9	146.3	145.7	145.3	144.9	144.2	30.0
34.0		33.5 m/95.6	126.6	125.9	125.1	124.5	124.0	123.5	122.8	34.0
38.0			96.3	109.8	109.0	108.3	107.7	107.2	106.4	38.0
42.0			38.7 m/91.5	97.3	96.4	95.6	94.9	94.3	93.5	42.0
46.0				43.9 m/87.4	81.9	85.3	84.6	84.0	83.1	46.0
50.0					49.1 m/80.1	76.9	76.1	75.4	74.5	50.0
54.0						70.4	69.0	68.3	67.3	54.0
58.0						54.3 m/69.9	63.1	62.2	61.3	58.0
62.0							59.5 m/61.4	57.1	56.1	62.0
66.0								64.7 m/54.3	51.8	66.0
70.0									69.8 m/48.0	70.0
reeves	32	32	32	28	24	20	20	16	16	reeves

※ Designed and rated to comply with ANSI Code B30.5.

Ratings shown in are determined by the strength of the boom or other structural components.

This is the rated for double drum.

Working Ranges

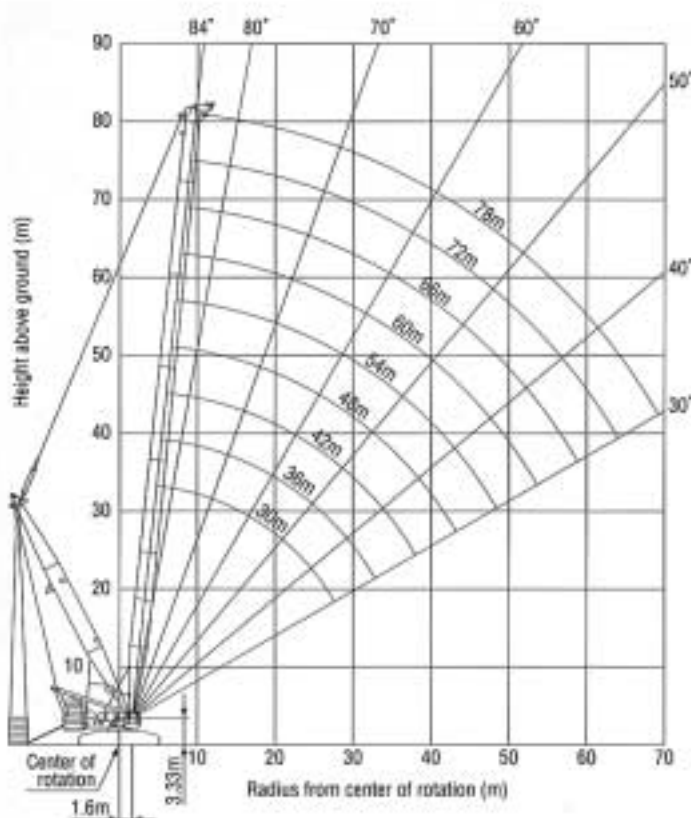

Boom Arrangement

Boom length	Boom arrangement
30 m	Base-A-A-B-Cap, Base-C-B-Cap
36 m	Base-A-C-B-Cap
42 m	Base-A-A-C-B-Cap, Base-C-C-B-Cap
48 m	Base-A-C-C-B-Cap
54 m	Base-A-A-C-C-B-Cap, Base-C-C-C-B-Cap
60 m	Base-A-C-C-C-B-Cap
66 m	Base-A-A-C-C-C-B-Cap, Base-C-C-C-C-B-Cap
72 m	Base-A-C-C-C-C-B-Cap
78 m	Base-A-A-C-C-C-C-B-Cap

Base = 9.0 m, Cap (Heavy-duty Cap) = 1.2 m,
Inserts: A = 6.0 m, B (tapered boom) = 7.8 m, C = 12.0 m

Mast Arrangement

Mast length	Mast arrangement
30 m	Base-C-Tip

Base = 9.0 m, Tip = 9.0 m
Inserts: C = 12.0 m

Light-duty Crane Rated Chart

7350
MasterTech

Light-duty boom

Counterweight 120 tons + Carbodyweight 41 tons

Unit: metric tons

Operating radius (m)	Boom length (m)													Operating radius (m)
	30.0	36.0	42.0	48.0	54.0	60.0	66.0	72.0	78.0	84.0	90.0	96.0		
5.0	5.3 m/113.5													5.0
6.0	113.5	6.0 m/113.5	6.6 m/113.5											6.0
7.0	113.5	113.5	113.5	7.2 m/113.5	7.8 m/113.5									7.0
8.0	113.5	113.5	113.5	113.5	113.5	8.5 m/113.5								8.0
9.0	113.5	113.5	113.5	113.5	113.5	113.5	9.1 m/113.5	9.7 m/99.4						9.0
10.0	113.5	113.5	113.5	113.5	113.5	113.5	113.5	99.4	10.4 m/99.4	11.0 m/95.2	11.6 m/75.9			10.0
12.0	113.5	113.5	113.5	113.5	113.5	110.9	106.9	99.4	98.0	85.2	75.4	12.2 m/53.0		12.0
14.0	113.5	113.5	113.0	108.6	104.3	100.3	96.2	92.6	88.5	85.0	73.1	51.5		14.0
16.0	105.2	104.9	104.3	98.7	94.6	90.8	87.0	83.6	80.2	77.3	70.9	49.8		16.0
18.0	89.7	89.3	88.7	88.1	84.0	80.5	76.9	73.8	70.7	68.5	64.8	48.2		18.0
20.0	78.0	77.6	77.0	76.3	74.1	71.1	68.0	65.0	62.3	60.3	57.0	46.7		20.0
22.0	68.9	68.4	67.8	67.2	66.4	63.5	60.5	57.8	55.1	53.8	50.8	45.2		22.0
24.0	61.6	61.1	60.4	59.8	59.1	57.0	54.4	51.8	49.4	47.8	45.3	42.4		24.0
26.0	55.6	55.1	54.4	53.7	53.0	52.2	49.0	46.6	44.3	42.8	40.7	38.5		26.0
28.0	27.9 m/51.0	50.0	49.4	48.7	47.9	47.2	44.5	42.2	40.2	38.9	36.9	34.8		28.0
30.0		45.8	45.1	44.4	43.7	42.9	40.7	38.5	36.5	35.2	33.4	31.5		30.0
34.0		33.1 m/40.6	38.3	37.6	36.8	36.0	33.8	31.8	30.2	29.0	27.5	26.3		34.0
38.0			33.1	32.4	31.6	30.4	28.4	26.5	25.5	24.5	23.3	22.0		38.0
42.0			38.3 m/32.9	28.3	27.5	26.0	24.1	22.4	21.3	20.3	19.5	18.2		42.0
46.0				43.5 m/27.1	23.9	22.2	20.4	18.9	17.8	16.8	16.1	15.0		46.0
50.0					48.7 m/21.5	18.9	17.3	15.8	14.8	14.0	13.3	12.7		50.0
54.0						53.9 m/16.2	14.7	13.2	12.5	11.7	11.2	10.3		54.0
58.0							12.5	11.2	10.3	9.7	9.1	8.3		58.0
62.0							59.1 m/12.0	9.4	8.4	7.8	7.3	6.6		62.0
66.0								64.3 m/8.3	6.6	6.2	5.8	5.1		66.0
70.0									69.5 m/5.4	4.7	4.4	3.7		70.0
74.0											3.4	3.1		74.0
78.0												74.7 m/3.2		78.0
reeves	9	9	9	9	9	9	9	8	8	7	6	4		reeves

⊞ Designed and rated to comply with ANSI Code B30.5.

Ratings shown in are determined by the strength of the boom or other structural components.

This is the rated for double drum.

Working Ranges

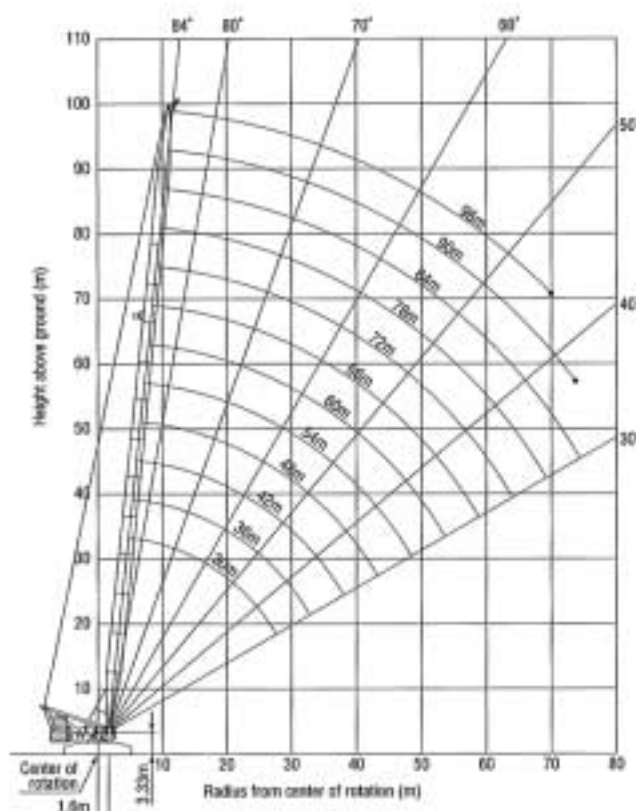

Boom Arrangement

Boom length	Boom arrangement
30 m	Base-A-D-Tip
36 m	Base-A-A-D-Tip, Base-C-D-Tip
42 m	Base-A-C-D-Tip
48 m	Base-A-A-C-D-Tip, Base-C-C-D-Tip
54 m	Base-A-C-C-D-Tip
60 m	Base-A-A-C-C-D-Tip, Base-C-C-C-D-Tip
66 m	Base-A-C-C-C-D-Tip
72 m	Base-A-A-C-C-C-D-Tip, Base-C-C-C-C-D-Tip
78 m	Base-A-C-C-C-C-D-Tip
84 m	Base-A-C-C-C-C-D-E-Tip
90 m	Base-A-C-C-C-C-D-E-E-Tip, Base-A-C-C-C-C-D-F-Tip
96 m	Base-A-C-C-C-C-D-E-F-Tip

Base = 9.0 m , Tip (Light-duty tip/Jib tip) = 9 m
 Inserts: A = 6.0 m, C = 12.0 m, D (6m tapered boom) = 6.0 m,
 E (6m insert jib) = 6.0 m, F (12m insert jib) = 12 m



Luffing jib:

Welded lattice construction using tubular, high-tensile steel chords with pin connections.

Luffing jib

Max. lifting capacity	113.5 tons at 16 m
Basic combinations (Main boom + jib)	24 m + 24 m
Max. combinations (Main boom + jib)	72 m + 66 m

Jib base	9 m
Jib tip	9 m
Max. jib length	54 m
No. of point sheave.....	5

HL Luffing jib

Max. lifting capacity	113.5 tons at 16 m
Basic combinations (Main boom + jib)	30 m + 24 m
Max. combinations (Main boom + jib)	72 m + 66 m

Jib base	9 m
Jib tip	9 m
Max. jib length	66 m
Mast	30 m
No. of point sheave.....	5

SHL Luffing jib

Max. lifting capacity	113.5 tons at 16 m
Basic combinations (Main boom + jib)	30 m + 24 m
Max. combinations (Main boom + jib)	78 m + 66 m

Jib base	9 m
Jib tip	9 m
Max. jib length	66 m
Mast	30 m
No. of point sheave.....	5



Hook blocks

A range of hook block can be specified, with a safety latch.

Lifting capacity	120 tons	70 tons	40 tons	13.5 tons (ball hook)
No. of sheave	5	3	1	—
Weight (kg)	3,500	3,100	2,000	650

Diameter of wire ropes

Hook hoist (Front)	28 mm
Hook hoist (Rear)	28 mm
Boom hoist (32 parts of line reeving)	26 mm
Jib hoist (14 parts of line reeving)	26 mm
Boom guy line (4 lines)	44 mm
Jib guy line (2 lines)	48 mm
Strut guy line (2 lines)	48 mm

Boom backstops

Required for all boom lengths.



Weight

Luffing Jib

Operating weight:

Approx. 385,000 kg
(including 24 m boom, 24 m jib, and 120-ton hook block)

Ground pressure: 167 kPa (1.7 kg/cm²) with 1,220 mm shoes

HL Luffing Jib

Operating weight:

Approx. 410,000 kg
(including 30 m boom, 24 m jib, and 120-ton hook block)

Ground pressure: 177 kPa (1.8 kg/cm²) with 1,220 mm shoes

SHL Luffing Jib

Operating weight:

Approx. 410,000 kg
(including 30 m boom, 24 m jib, and 120-ton hook block)

Ground pressure: 177 kPa (1.8 kg/cm²) with 1,220 mm shoes

Notes:

1. Operating radius is the horizontal distance from the center of rotation to the center of gravity of the load.
2. Rated loads included in the charts are the maximum allowable freely suspended loads at a given tower length and jib length, Boom and jib angle, and radius, and have been determined for the machine standing level on firm supporting surface under ideal operating conditions. The user must limit or de-rate loads to allow for adverse conditions (such as soft or uneven ground, out-of-level conditions, winds, side loads, pendulum action, jerking or sudden stopping of loads, inexperience of personnel, multiple machine lifts, and traveling with a load).
3. Capacities do not exceed 75% of minimum tipping loads. Capacities based on factors other than machine stability such as structural competence are indicated by shaded area. Attempt to over load could damage the boom, jib and frame, etc. without tipping.
4. The rated loads are determined in accordance with ANSI Code B30.5.
5. Areas on rated charts where no rating are shown, operation is not intended or approved.
6. Actual allowable loads of tower jib must not exceed either the maximum load at the each number of reeving mentioned in the following article 9, or the rated loads for the boom length. Actual hoistable loads using the tower jib are determined by deducting the weight of the load-handling gear (such as hook block, slings and cables) from the ratings and should not exceed the ratings for the hook block.
7. For configurations of insert booms and guy cable assembly, instructions in the operator's manual must be strictly observed.
8. When operating luffing boom, jib angle must be maintained between 15° to 73° from the horizontal line at the each fixed tower angle (66°, 76° and 86°).
9. Max. hoisting load by number of reeving
10. An auxiliary sheave can be fitted to luffing tower of 30 m tower + 24 m jib, to 72 m tower + 54 m jib.
11. Rated loads for auxiliary sheave are determined by deducting the auxiliary sheave weight (550 kg) and weight of hook block (650 kg) and load handling gear (sling and cables) from luffing tower ratings, but must not exceed a maximum 13.5 ton.
12. The maximum operating radius of an auxiliary sheave must not exceed the maximum operating radius of the luffing tower. The minimum operating radius of the auxiliary sheave is determined by the equivalent angles of boom and jib at the minimum radius.
13. Rated loads for the tower jib with an auxiliary sheave attached are determined by deducting the sheave weight from luffing tower ratings. Where a 13.5-ton ball hook is fitted, the weight of the hook must also be deducted.
14. Actual allowable loads of the tower jib when an auxiliary sheave is attached are determined by deducting the weight of the load handling gear (such as hook block, slings and cables) from the ratings so determined in the article 12.
15. Do not operate the main hook and auxiliary sheave hook simultaneously.
16. Refer to the operator's manual for appropriate type of hook block and number of reeving at each luffing tower length.
17. Always have the gantry fully raised and use the backstop during luffing tower operations.
18. Boom hoist reeving must be twenty parts of line.
19. Jib hoist reeving must be ten parts of line.
20. The weights of standard counterweight and carbody counterweight are as follows:
Standard counterweight; 120 ton + 35 ton
Standard carbody counterweight; 41 ton.
21. In principle, the boom should be erected over the front of the crawlers.
22. When tower length is over 60 m, pillow plates for crawlers must be used for erection.
23. Figures shown by (ft) in the boom configuration are for reference only.

No. of hoist reeving	1	2	3	4	5	6	7	8	9
Max. load (ton)	13.5	27.0	40.0	53.0	65.5	78.0	90.0	101.5	113.5

Working Ranges

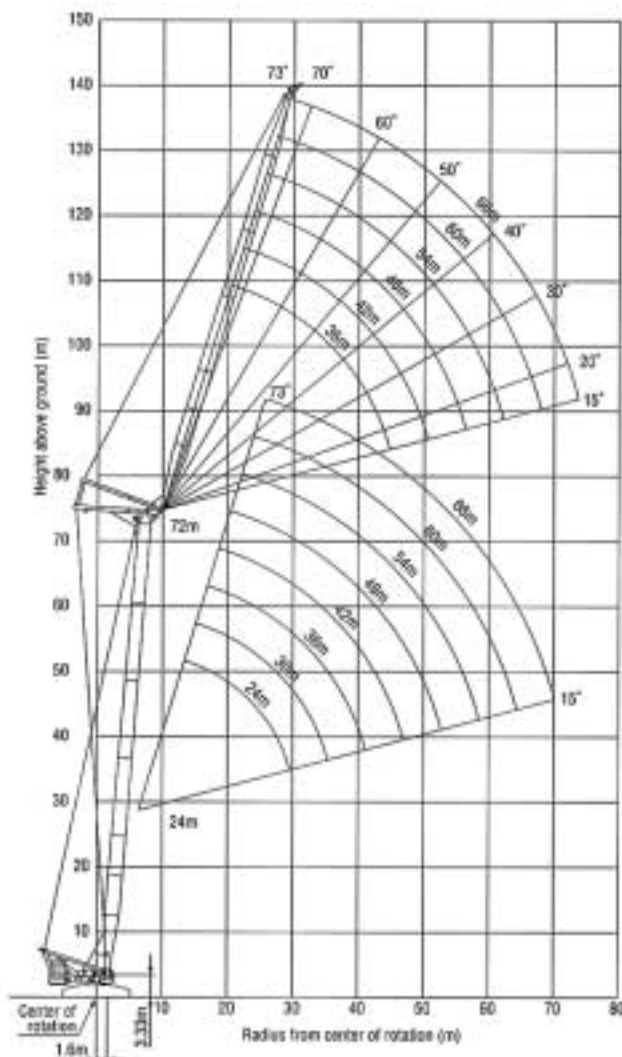

Boom Arrangement

Boom length	Boom arrangement
24 m	Base-A-T-Cap
30 m	Base-A-A-T-Cap, Base-C-T-Cap
36 m	Base-A-C-T-Cap
42 m	Base-A-A-C-T-Cap, Base-C-C-T-Cap
48 m	Base-A-C-C-T-Cap
54 m	Base-A-A-C-C-T-Cap, Base-C-C-C-T-Cap
60 m	Base-A-C-C-C-T-Cap
66 m	Base-A-A-C-C-C-T-Cap
72 m	Base-A-C-C-C-C-T-Cap
78 m	Base-A-A-C-C-C-C-T-Cap

Base = 9.0 m, Cap (Heavy-duty Cap) = 1.2 m,
 Inserts: A = 6.0 m, B = 7.8 m, C = 12.0 m

Jib Arrangement

Jib length	Jib arrangement
24 m	Base-E-Jib tip
30 m	Base-E-E-Jib tip, Base-F-Jib tip
36 m	Base-E-F-Jib tip
42 m	Base-E-E-F-Jib tip, Base-F-F-Jib tip
48 m	Base-E-F-F-Jib tip
54 m	Base-E-E-F-F-Jib tip, Base-F-F-F-Jib tip
60 m	Base-E-F-F-F-Jib tip
66 m	Base-E-E-F-F-F-Jib tip

Base (jib base) = 9.0 m, Jib Tip (light-duty tip/Jib tip) = 9.0 m
 Inserts (jib): E (luffing jib insert) = 6.0 m, F (luffing jib insert) = 12.0 m

Luffing Boom and Jib Combinations

Boom Length	24 m jib	30 m jib	36 m jib	42 m jib	48 m jib	54 m jib	60m jib	66 m jib
24 m	○*	○*	○*	○*	○*	○*	○*	○*
30 m	○	○	○	○	○	○	○	○
36 m	×	○	○	○	○	○	○	○
42 m	×	○	○	○	○	○	○	○
48 m	×	○	○	○	○	○	○	○
54 m	×	○	○	○	○	○	○	○
60 m	×	×	○	○	○	○	○	○
66 m	×	×	○	○	○	○	○	○
72 m	×	×	○	○	○	○	○	○

× : All Luffing Jib Combinations Which is None.
 ○ : All Luffing Jib Combinations Which is Allowed.
 ○* : STD Luffing Jib Combinations Which is Allowed.

Luffing Jib Rated Charts

7350
MasterTech

**(1) 24 m luffing jib rated loads in metric tons for 360° working area
(Counterweight 120 t + 35 t, Carbody weight 41 t)**

Unit: metric ton

Operating radius (m)	24.0 m Boom												Operating radius (m)
	24.0 m Jib			30.0 m Jib			35.0 m Jib			42.0 m Jib			
	Boom angle			Boom angle			Boom angle			Boom angle			
	86°	76°	66°	86°	76°	66°	86°	76°	66°	86°	76°	66°	
14.0	113.5												14.0
16.0	113.5			113.5									16.0
18.0	106.2			105.4			104.3						18.0
20.0	93.3			92.7			91.7			91.0			20.0
22.0	83.1	78.5		82.5			81.6			81.1			22.0
24.0	74.8	70.7		74.2			73.3			72.8			24.0
26.0	67.9	64.1		67.3	63.3		66.4			66.0			26.0
28.0	60.0	58.6		61.6	57.8		60.7	56.7		60.2			28.0
30.0		53.9	51.0	56.6	53.1		55.7	52.1		55.2	51.4		30.0
34.0			43.7	48.7	45.6	42.9	47.8	44.6		47.2	43.9		34.0
38.0					39.7	37.3	41.7	38.8	36.2	41.1	38.1		38.0
42.0						32.9		34.2	31.9	36.2	33.5	31.1	42.0
46.0										28.4	32.4	29.8	46.0
50.0												26.8	50.0
54.0													54.0
Reeves	9			9			9			8			Reeves

※ Designed and rated to comply with ANSI Code B30.5.

Ratings shown in are determined by the strength of the boom or other structural components.

Unit: metric ton

Operating radius (m)	24.0 m Boom												Operating radius (m)
	48 m Jib			54 m Jib			60 m Jib			66 m Jib			
	Boom angle			Boom angle			Boom angle			Boom angle			
	86°	76°	66°	86°	76°	66°	86°	76°	66°	86°	76°	66°	
22.0	80.1												22.0
24.0	72.3			70.8			64.4						24.0
26.0	65.4			65.0			61.1			55.4			26.0
28.0	59.6			59.2			58.1			52.7			28.0
30.0	54.6			54.2			53.3			50.2			30.0
34.0	46.6	43.2		46.2			45.2			44.8			34.0
38.0	40.4	37.4		39.9	36.8		39.0	35.8		38.6			38.0
42.0	35.5	32.7		35.0	32.1		34.1	31.1		33.6	30.6		42.0
46.0	31.6	29.0	26.7	31.0	28.4		30.1	27.4		29.6	26.8		46.0
50.0	28.3	25.9	23.8	27.7	25.3	23.1	26.7	24.3		26.2	23.7		50.0
54.0		23.4	21.4	24.8	22.7	20.7	24.0	21.7	19.6	23.4	21.1		54.0
58.0			19.4	22.7	20.5	18.6	21.6	19.5	17.6	20.9	18.9	16.9	58.0
62.0					18.7	16.9	19.4	17.6	15.8	18.3	16.9	15.1	62.0
66.0						15.4		16.0	14.3	16.2	15.3	13.6	66.0
70.0									13.0		13.9	12.2	70.0
74.0												11.1	74.0
Reeves	7			6			5			5			Reeves

※ Designed and rated to comply with ANSI Code B30.5.

Ratings shown in are determined by the strength of the boom or other structural components.

Luffing Jib Rated Charts

7350
MasterTech

(2) 36 m luffing jib rated loads in metric tons for 360° working area
(Counterweight 120 t + 35 t, Carbody weight 41 t)

Unit: metric ton

Operating radius (m)	36.0 m Boom												Operating radius (m)
	30.0 m Jib			36.0 m Jib			42.0 m Jib			48.0 m Jib			
	Boom angle			Boom angle			Boom angle			Boom angle			
	66°	76°	66°	66°	76°	66°	66°	76°	66°	66°	76°	66°	
16.0	113.5												16.0
18.0	102.2			99.4									18.0
20.0	89.7			88.7			88.0						20.0
22.0	79.8			78.8			78.4			77.3			22.0
24.0	71.7			70.8			70.3			69.8			24.0
26.0	65.0			64.1			63.6			63.1			26.0
28.0	59.4	53.3		58.5			58.0			57.4			28.0
30.0	54.5	48.9		53.6	47.8		53.1			52.6			30.0
34.0	46.7	41.8		45.9	40.7		45.4	40.1		44.8			34.0
38.0		36.4	32.4	39.9	35.3		39.4	34.6		38.8	33.9		38.0
42.0		32.0	28.5		31.0	27.3	34.6	30.3		34.0	29.6		42.0
46.0			25.4		27.6	24.2	30.8	26.8	23.4	30.1	26.1		46.0
50.0						21.6		24.0	20.8	26.9	23.2	19.9	50.0
54.0									18.6		20.8	17.7	54.0
58.0									16.8		18.8	15.9	58.0
62.0												14.3	62.0
Reeves	9			8			7			6			Reeves

⊗ Designed and rated to comply with ANSI Code B30.5.

Ratings shown in are determined by the strength of the boom or other structural components.

Operating radius (m)	36.0 m Boom									Operating radius (m)
	54.0 m Jib			60.0 m Jib			66.0 m Jib			
	Boom angle			Boom angle			Boom angle			
	66°	76°	66°	66°	76°	66°	66°	76°	66°	
22.0										22.0
24.0	68.4									24.0
26.0	62.7			60.9						26.0
28.0	57.0			56.7			53.3			28.0
30.0	52.2			51.8			50.8			30.0
34.0	44.3			43.9			43.0			34.0
38.0	38.3	33.3		37.8			36.9			38.0
42.0	33.5	28.9		33.0	28.3		32.1			42.0
46.0	29.6	25.4		29.0	24.8		28.2	23.8		46.0
50.0	26.3	22.5		25.8	21.9		24.9	20.9		50.0
54.0	23.7	20.1	17.0	23.0	19.4		22.2	18.5		54.0
58.0	21.4	18.1	15.1	20.7	17.4	14.4	19.9	16.4		58.0
62.0		16.3	13.6	18.8	15.6	12.8	17.9	14.7	11.8	62.0
66.0			12.2		14.1	11.4	16.2	13.1	10.4	66.0
70.0			11.1		12.8	10.2	14.8	11.8	9.2	70.0
74.0						9.2		10.7	8.2	74.0
78.0									7.3	78.0
82.0									6.6	82.0
Reeves	0			0			0			Reeves

⊗ Designed and rated to comply with ANSI Code B30.5.

Ratings shown in are determined by the strength of the boom or other structural components.

Luffing Jib Rated Charts

7350
MasterTech

(3) 48 m luffing jib rated loads in metric tons for 360° working area (Counterweight 120 t + 35 t, Carbody weight 41 t)

Unit: metric ton

Operating radius (m)	48.0 m Boom												Operating radius (m)
	30.0 m Jib			36.0 m Jib			42.0 m Jib			48.0 m Jib			
	Boom angle			Boom angle			Boom angle			Boom angle			
	85°	75°	66°	86°	76°	66°	86°	76°	66°	86°	76°	66°	
18.0	99.4												18.0
20.0	87.4			85.2									20.0
22.0	77.7			77.3			75.7						22.0
24.0	69.8			69.3			68.4			68.0			24.0
26.0	63.2			62.7			61.9			61.4			26.0
28.0	57.7			57.2			56.3			55.9			28.0
30.0	52.9	44.9		52.5			51.6			51.1			30.0
34.0	45.3	38.3		44.8	37.5		44.0			43.5			34.0
38.0		33.2		38.9	32.4		38.1	31.4		37.6			38.0
42.0		29.1		34.2	28.4		33.4	27.4		32.9	26.6		42.0
46.0			21.0		25.1	20.1	29.7	24.1		29.1	23.4		46.0
50.0			18.7		22.4	17.8		21.5	16.7	25.9	20.7		50.0
54.0						15.9		19.2	14.8		18.5	13.9	54.0
58.0						14.3			13.2		16.6	12.3	58.0
62.0									11.9		15.0	11.0	62.0
66.0												9.8	66.0
70.0												8.9	70.0
Reeves	8			7			6			6			Reeves

※ Designed and rated to comply with ANSI Code B30.5.

Ratings shown in are determined by the strength of the boom or other structural components.

Operating radius (m)	48.0 m Boom									Operating radius (m)
	54.0 m Jib			60.0 m Jib			66.0 m Jib			
	Boom angle			Boom angle			Boom angle			
	86°	76°	66°	86°	76°	66°	86°	76°	66°	
24.0	65.9									24.0
26.0	60.5			58.5						26.0
28.0	55.0			54.6			51.9			28.0
30.0	50.3			49.9			49.0			30.0
34.0	42.6			42.2			41.3			34.0
38.0	36.7			36.3			35.4			38.0
42.0	32.0	25.6		31.5			30.7			42.0
46.0	28.2	22.4		27.7	21.7		26.9			46.0
50.0	25.1	19.7		24.6	19.1		23.7	18.1		50.0
54.0	22.5	17.5		21.9	16.8		21.0	15.9		54.0
58.0	20.3	15.6	11.3	19.6	14.9		18.8	14.0		58.0
62.0		14.0	9.9	17.7	13.3	9.1	16.9	12.3		62.0
66.0		12.6	8.8		11.9	8.0	15.2	10.9		66.0
70.0			7.8		10.7	7.0	13.8	9.7		70.0
74.0			7.0			6.1		8.6		74.0
78.0						5.3		7.7		78.0
Reeves	6			5			4			Reeves

※ Designed and rated to comply with ANSI Code B30.5.

Ratings shown in are determined by the strength of the boom or other structural components.

Luffing Jib Rated Charts

7350
MasterTech

(4) 60 m luffing jib rated loads in metric tons for 360° working area
(Counterweight 120 t + 35 t, Carbody weight 41 t)

Unit: metric ton

Operating radius (m)	60.0 m Boom												Operating radius (m)
	36.0 m Jib			42.0 m Jib			48.0 m Jib			54 m Jib			
	Boom angle			Boom angle			Boom angle			Boom angle			
	86°	76°	66°	86°	76°	66°	86°	76°	66°	86°	76°	66°	
20.0	71.0												20.0
22.0	71.0			71.0									22.0
24.0	67.0			66.5			64.4						24.0
26.0	60.6			60.3			59.3			56.8			26.0
28.0	55.2			54.9			53.9			53.6			28.0
30.0	50.6			50.3			49.3			49.0			30.0
34.0	43.1			42.8			41.8			41.5			34.0
38.0	37.4	26.6		37.0			36.1			35.7			38.0
42.0	32.8	24.9		32.4	24.3		31.5	23.1		31.1			42.0
46.0		21.9		28.7	21.3		27.8	20.2		27.4	19.6		46.0
50.0		19.5			18.8		24.7	17.7		24.3	17.1		50.0
54.0			11.6		16.8		22.2	15.7		21.7	15.1		54.0
58.0			10.2		15.1	9.5		13.9		19.5	13.4		58.0
62.0			9.1			8.3		12.5			11.9		62.0
66.0						7.4					10.6		66.0
70.0											9.5		70.0
Reeves	6			6			5			5			Reeves

■ Designed and rated to comply with ANSI Code B30.5.

Ratings shown in are determined by the strength of the boom or other structural components.

Unit: metric ton

Operating radius (m)	60.0 m Boom						Operating radius (m)
	60.0 m Jib			65.0 m Jib			
	Boom angle			Boom angle			
	86°	76°	66°	86°	76°	66°	
28.0	50.7			50.0			28.0
30.0	48.0			47.9			30.0
34.0	40.5			40.3			34.0
38.0	34.7			34.5			38.0
42.0	30.2			29.9			42.0
46.0	26.4			26.1			46.0
50.0	23.4	16.0		23.0	15.5		50.0
54.0	20.8	14.0		20.4	13.5		54.0
58.0	18.6	12.3		18.2	11.8		58.0
62.0	16.7	10.8		16.3	10.3		62.0
66.0	15.1	9.5		14.6	9.0		66.0
70.0		8.4		8.2	7.9		70.0
74.0		7.5			6.9		74.0
78.0					6.0		78.0
82.0					5.3		82.0
Reeves	4			4			Reeves

■ Designed with and rated to comply with ANSI Code B30.5.

Ratings shown in are determined by the strength of the boom or other structural components.

Luffing Jib Rated Charts

7350
MasterTech

**(5) 72 m luffing jib rated loads in metric tons for 360° working area
(Counterweight 120 t + 35 t, Carbody weight 41 t)**

Unit: metric ton

Operating radius (m)	72.0 m Boom												Operating radius (m)
	36.0 m Jib			42.0 m Jib			48.0 m Jib			54 m Jib			
	Boom angle			Boom angle			Boom angle			Boom angle			
	86°	76°	66°	86°	76°	66°	86°	76°	66°	86°	76°	66°	
22.0	58.3			57.5									22.0
24.0	53.3			52.8			51.9						24.0
26.0	49.0			48.6			48.0			47.0			26.0
28.0	45.3			44.9			44.3			43.8			28.0
30.0	41.9			41.7			41.1			40.6			30.0
34.0	36.3			36.2			35.6			35.2			34.0
38.0	31.8			31.7			31.2			30.9			38.0
42.0	27.9	21.6		28.0	21.0		27.6			27.3			42.0
46.0		18.9		24.9	18.3		24.5	17.1		24.3			46.0
50.0		16.6			16.1		21.9	14.9		21.7	14.4		50.0
54.0		14.8			14.2		19.5	13.1		19.5	12.5		54.0
58.0					12.6			11.5		17.5	11.0		58.0
62.0					11.3			10.2			9.6		62.0
66.0								9.1			8.5		66.0
70.0											7.5		70.0
Reeves	5			5			4			4			Reeves

≡ Designed and rated to comply with ANSI Code B30.5.

Ratings shown in are determined by the strength of the boom or other structural components.

Working Ranges

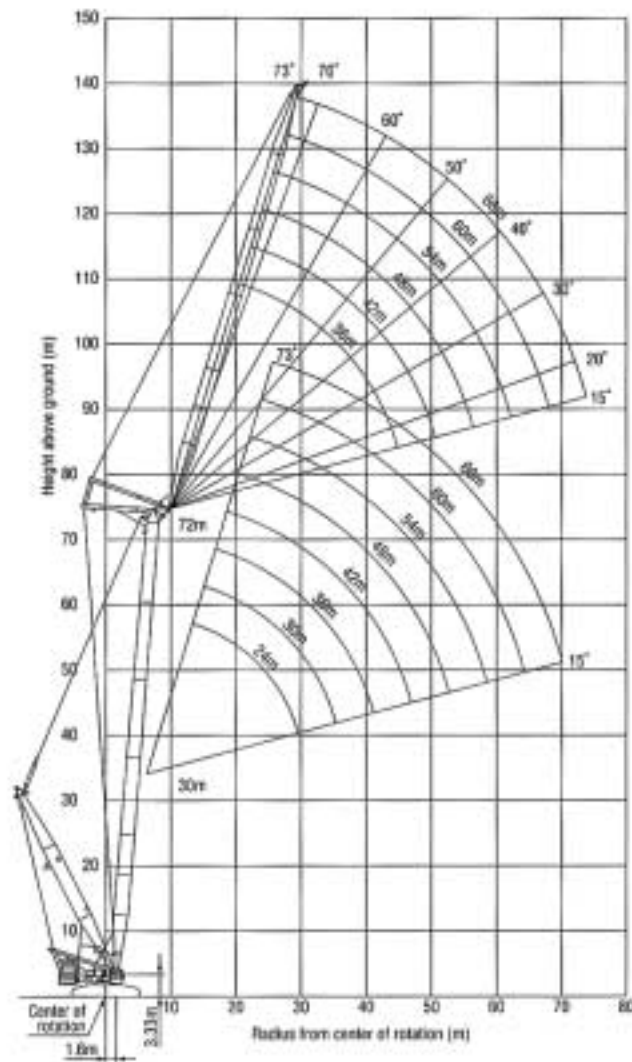

Boom Arrangement

Boom length	Boom arrangement
30 m	Base-A-A-T-Cap, Base-C-T-Cap
36 m	Base-A-C-T-Cap
42 m	Base-A-A-C-T-Cap, Base-C-C-T-Cap
48 m	Base-A-C-C-T-Cap
54 m	Base-A-A-C-C-T-Cap, Base-C-C-C-T-Cap
60 m	Base-A-C-C-C-T-Cap
66 m	Base-A-A-C-C-C-T-Cap, Base-C-C-C-C-T-Cap
72 m	Base-A-C-C-C-C-T-Cap
78 m	Base-A-A-C-C-C-C-T-Cap

Base = 9.0 m, Cap (Boom Cap) = 1.2 m
 Inserts: A = 6.0 m, B = 7.8 m, C = 12.0 m

Jib Arrangement

Jib length	Jib arrangement
24 m	Base-E-Jib tip
30 m	Base-E-E-Jib tip, Base-F-Jib tip
36 m	Base-E-F-Jib tip
42 m	Base-E-E-F-Jib tip, Base-F-F-Jib tip
48 m	Base-E-F-F-Jib tip
54 m	Base-E-E-F-F-Jib tip, Base-F-F-F-Jib tip
60 m	Base-E-F-F-F-Jib tip
66 m	Base-E-E-F-F-F-Jib tip

Base (jib base) = 9.0 m, Jib Tip (light-duty tip/Jib tip) = 9.0 m
 Inserts (jib): E (luffing jib insert) = 6.0 m, F (luffing jib insert) = 12.0 m

Luffing Boom and Jib Combinations

Boom Length	24 m jib	30 m jib	36 m jib	42 m jib	48 m jib	54 m jib	60m jib	66 m jib
30 m	○	○	○	○	○	○	○	○
36 m	×	○	○	○	○	○	○	○
42 m	×	○	○	○	○	○	○	○
48 m	×	○	○	○	○	○	○	○
54 m	×	○	○	○	○	○	○	○
60 m	×	×	○	○	○	○	○	○
66 m	×	×	○	○	○	○	○	○
72 m	×	×	○	○	○	○	○	○
78 m	×	×	○**	○**	○**	○**	○**	○**

× : All Luffing Jib Combinations Which is None.
 ○ : All Luffing Jib Combinations Which is Allowed.
 ○** : SHL Luffing Jib Combinations Which is Allowed.

HL Luffing Jib Rated Charts

7350
MasterTech

(1) 30 m luffing jib rated loads in metric tons for 360° working area
(Counterweight 120 t + 35 t, Carbody weight 41 t)

Unit: metric ton

Operating radius (m)	30.0 m Boom												Operating radius (m)
	24.0 m Jib			30.0 m Jib			36.0 m Jib			42.0 m Jib			
	Boom angle			Boom angle			Boom angle			Boom angle			
	86°	76°	66°	86°	76°	66°	86°	76°	66°	86°	76°	66°	
14.0	113.5												14.0
16.0	113.5			113.5									16.0
18.0	111.2			107.8			104.8						18.0
20.0	101.9			99.7			96.8			93.8			20.0
22.0	93.4			90.7			88.8			87.4			22.0
24.0	85.4	80.3		83.3			81.0			79.4			24.0
26.0	75.9	72.4		76.6	71.9		74.5			72.7			26.0
28.0	67.5	65.6		69.4	65.3		68.9			66.9			28.0
30.0		60.2		62.5	59.8		62.9	59.1		62.0			30.0
34.0		51.3	47.6	51.5	51.0		52.1	50.3		52.2	49.8		34.0
38.0			41.3		44.3	40.8	44.1	43.6		44.0	43.2		38.0
42.0						35.9		38.4	35.1	37.7	38.0		42.0
46.0								34.2	31.3	32.9	33.8	30.7	46.0
50.0									28.1		30.4	27.6	50.0
54.0												24.9	54.0
Reeves	9			9			9			8			Reeves

※ Designed and rated to comply with ANSI Code B30.5.

Ratings shown in are determined by the strength of the boom or other structural components.

Unit: metric ton

Operating radius (m)	30.0 m Boom												Operating radius (m)
	48.0 m Jib			54.0 m Jib			60.0 m Jib			66.0 m Jib			
	Boom angle			Boom angle			Boom angle			Boom angle			
	86°	76°	66°	86°	76°	66°	86°	76°	66°	86°	76°	66°	
22.0	82.6												22.0
24.0	77.9			71.3									24.0
26.0	71.0			67.7			61.4						26.0
28.0	65.1			63.6			58.4			53.0			28.0
30.0	60.0			58.4			55.6			50.5			30.0
34.0	51.6	49.3		49.8			48.0			45.8			34.0
38.0	44.0	42.7		43.2	42.0		41.2			39.4			38.0
42.0	37.7	37.5		37.5	37.0		35.7	36.5		33.8	35.2		42.0
46.0	32.7	33.3	30.1	32.5	32.8		31.2	32.4		29.2	31.7		46.0
50.0	28.6	29.8	27.0	28.4	29.4	26.5	27.6	28.9		25.4	28.3		50.0
54.0		27.0	24.3	25.0	26.5	23.8	24.4	26.0	23.3	22.2	25.4		54.0
58.0			22.1	22.6	24.1	21.6	21.6	23.6	21.0	19.6	23.0	20.3	58.0
62.0			20.2		22.0	19.7	19.2	21.5	19.1	17.3	20.9	18.5	62.0
66.0						18.0		19.7	17.5	15.4	19.1	16.8	66.0
70.0									16.0	14.0	17.5	15.4	70.0
74.0									14.8		16.2	14.1	74.0
78.0												13.0	78.0
Reeves	7			6			5			4			Reeves

※ Designed and rated to comply with ANSI Code B30.5.

Ratings shown in are determined by the strength of the boom or other structural components.

HL Luffing Jib Rated Charts

7350
MasterTech

**(1) 42 m luffing jib rated loads in metric tons for 360° working area
(Counterweight 120 t + 35 t, Carbody weight 41 t)**

Unit: metric ton

Operating radius (m)	42.0 m Boom												Operating radius (m)
	30.0 m Jib			36.0 m Jib			42.0 m Jib			48.0 m Jib			
	Boom angle			Boom angle			Boom angle			Boom angle			
	86°	76°	66°	86°	76°	66°	86°	76°	66°	86°	76°	66°	
18.0	113.5												18.0
20.0	106.9			99.4			98.3						20.0
22.0	94.7			94.3			92.4			84.1			22.0
24.0	84.4			83.9			83.3			79.5			24.0
26.0	75.9			75.5			74.9			74.5			26.0
28.0	68.9			68.5			67.9			67.5			28.0
30.0	63.0	57.0		62.6			62.0			61.7			30.0
34.0	53.2	48.6		53.3	47.8		52.6	47.3		52.3			34.0
38.0		42.1		45.2	41.4		45.1	40.9		45.2	40.4		38.0
42.0		37.1	32.6		36.4		38.5	35.9		38.5	35.4		42.0
46.0			29.0		32.4	28.2	33.2	31.9		33.3	31.4		46.0
50.0			26.1			25.2		28.6	24.7	29.0	28.1		50.0
54.0						22.8		25.9	22.2		25.3	21.6	54.0
58.0									20.2		23.0	19.6	58.0
62.0									18.5			17.8	62.0
66.0												16.3	66.0
70.0													70.0
Reeves	9			8			8			7			Reeves

⊞ Designed and rated to comply with ANSI Code B30.5.

Ratings shown in are determined by the strength of the boom or other structural components.

Unit: metric ton

Operating radius (m)	42.0 m Boom									Operating radius (m)
	54.0 m Jib			60.0 m Jib			66.0 m Jib			
	Boom angle			Boom angle			Boom angle			
	86°	76°	66°	86°	76°	66°	86°	76°	66°	
24.0	71.0									24.0
26.0	68.8			62.3						26.0
28.0	65.2			59.2			53.7			28.0
30.0	61.2			56.3			51.1			30.0
34.0	51.9			51.0			46.3			34.0
38.0	44.8			44.5			42.1			38.0
42.0	38.4	35.0		38.3			38.1			42.0
46.0	33.1	30.9		33.0	30.5		32.8	29.1		46.0
50.0	28.8	27.6		28.7	27.2		28.3	26.5		50.0
54.0	25.3	24.9		25.1	24.4		24.6	23.8		54.0
58.0	22.4	22.5	19.0	22.2	22.1	18.5	21.5	21.4		58.0
62.0		20.6	17.3	19.7	20.1	16.7	18.9	19.4	16.0	62.0
66.0		18.9	15.8		18.3	15.2	16.6	17.7	14.5	66.0
70.0			14.5		16.8	13.9	14.4	16.2	13.2	70.0
74.0						12.7		14.9	12.0	74.0
78.0						11.7		13.8	10.9	78.0
82.0									10.0	82.0
Reeves	6			5			5			Reeves

⊞ Designed and rated to comply with ANSI Code B30.5.

Ratings shown in are determined by the strength of the boom or other structural components.

HL Luffing Jib Rated Charts

7350
MasterTech

(2) 54 m luffing jib rated loads in metric tons for 360° working area
(Counterweight 120 t + 35 t, Carbody weight 41 t)

Unit: metric ton

Operating radius (m)	54.0 m Boom												Operating radius (m)
	30.0 m Jib			36.0 m Jib			42.0 m Jib			48.0 m Jib			
	Boom angle			Boom angle			Boom angle			Boom angle			
	86°	76°	66°	86°	76°	66°	86°	76°	66°	86°	76°	66°	
18.0	85.2												18.0
20.0	85.2			85.2									20.0
22.0	85.2			85.2			71.0						22.0
24.0	83.5			83.1			71.0			71.0			24.0
26.0	75.2			74.7			71.0			71.0			26.0
28.0	68.2			67.7			67.3			67.0			28.0
30.0	62.3			61.9			61.5			61.2			30.0
34.0	53.0	46.1		52.6			52.2			51.9			34.0
38.0		39.9		45.5	39.1		45.1	38.6		44.8			38.0
42.0		35.0		39.5	34.3		39.6	33.8		39.3	33.3		42.0
46.0		31.2	25.9		30.4		34.1	30.0		34.3	29.4		46.0
50.0			23.2		27.3	22.3		26.8		29.8	26.3		50.0
54.0			20.9			20.0		24.2	19.5	25.8	23.6		54.0
58.0						18.2		22.0	17.6		21.4	16.9	58.0
62.0										16.0	19.5	15.3	62.0
66.0										14.7		14.0	66.0
70.0												12.8	70.0
Reeves		7			7			6			6		Reeves

※ Designed and rated to comply with ANSI Code B30.5.

Ratings shown in are determined by the strength of the boom or other structural components.

Unit: metric ton

Operating radius (m)	54.0 m Boom									Operating radius (m)
	54.0 m Jib			60.0 m Jib			66.0 m Jib			
	Boom angle			Boom angle			Boom angle			
	86°	76°	66°	86°	76°	66°	86°	76°	66°	
26.0	69.9			56.8						26.0
28.0	66.3			56.8			54.4			28.0
30.0	60.5			56.8			51.7			30.0
34.0	51.2			50.9			46.9			34.0
38.0	44.2			43.9			42.6			38.0
42.0	38.6			38.3			38.0			42.0
46.0	33.8	29.0		33.7	27.9		33.5			46.0
50.0	29.3	25.8		29.2	25.1		29.0	24.7		50.0
54.0	25.7	23.2		25.6	22.4		25.1	22.0		54.0
58.0	22.6	21.0		22.5	20.2		21.9	19.8		58.0
62.0		19.1	14.8	19.9	18.3		19.2	17.9		62.0
66.0		17.4	13.4		16.7	12.3	16.8	16.3		66.0
70.0			12.1		15.3	11.1	14.7	14.8	10.5	70.0
74.0			11.0		14.1	10.0		13.6	9.4	74.0
78.0			10.1			9.0		12.5	8.4	78.0
82.0						8.2			7.6	82.0
86.0									6.8	86.0
90.0									6.2	90.0
Reeves		6			5			5		Reeves

※ Designed and rated to comply with ANSI Code B30.5.

Ratings shown in are determined by the strength of the boom or other structural components.

HL Luffing Jib Rated Charts

7350
MasterTech

(3) 66 m luffing jib rated loads in metric tons for 360° working area
(Counterweight 120 t + 35 t, Carbody weight 41 t)

Unit: metric ton

Operating radius (m)	66.0 m Boom												Operating radius (m)
	36.0 m Jib			42.0 m Jib			48.0 m Jib			54.0 m Jib			
	Boom angle			Boom angle			Boom angle			Boom angle			
	86°	76°	66°	86°	76°	66°	86°	76°	66°	86°	76°	66°	
20.0	71.0												20.0
22.0	71.0			71.0									22.0
24.0	71.0			71.0			56.8						24.0
26.0	71.0			71.0			56.8			56.8			26.0
28.0	66.9			66.5			56.8			56.8			28.0
30.0	61.1			60.7			56.8			56.8			30.0
34.0	51.8			51.4			51.2			50.8			34.0
38.0	44.8	36.4		44.4			44.2			43.8			38.0
42.0	39.3	31.8		38.9	31.3		38.7			38.3			42.0
46.0		28.2		34.5	27.7		34.2	27.1		33.9	26.4		46.0
50.0		25.2			24.7		30.4	24.2		30.2	23.7		50.0
54.0		22.7	16.8		22.2		26.9	21.7		26.5	21.2		54.0
58.0			15.0		20.1	14.3		19.6		23.3	19.1		58.0
62.0			13.5			12.8		17.8	12.0		17.4		62.0
66.0			12.3			11.5		16.3	10.7		15.8	10.1	66.0
70.0						10.5			9.6		14.5	9.0	70.0
74.0									8.7			8.0	74.0
78.0												7.2	78.0
Reeves		6			6			5			5		Reeves

Ⓜ Designed and rated to comply with ANSI Code B30.5.

Ratings shown in are determined by the strength of the boom or other structural components.

Unit: metric ton

Operating radius (m)	66.0 m Boom						Operating radius (m)
	60.0 m Jib			65.0 m Jib			
	Boom angle			Boom angle			
	86°	76°	66°	85°	75°	66°	
28.0	56.8						28.0
30.0	56.8			42.6			30.0
34.0	50.5			42.6			34.0
38.0	43.5			42.6			38.0
42.0	38.0			37.4			42.0
46.0	33.6			32.9			46.0
50.0	30.0	23.3		29.3			50.0
54.0	26.5	20.8		25.7	20.1		54.0
58.0	23.3	18.7		22.3	18.0		58.0
62.0	20.8	16.9		19.5	16.2		62.0
66.0	18.6	15.3		16.3	14.6		66.0
70.0		14.0	8.3	12.7	13.3		70.0
74.0		12.8	7.3		12.1		74.0
78.0		11.8	6.5		10.9		78.0
82.0			5.7		10.0		82.0
Reeves		5			4		Reeves

Ⓜ Designed and rated to comply with ANSI Code B30.5.

Ratings shown in are determined by the strength of the boom or other structural components.

HL Luffing Jib Rated Charts

7350
MasterTech

(4) 72 m luffing jib rated loads in metric tons for 360° working area (Counterweight 120 t + 35 t, Carbody weight 41 t)

Unit: metric ton

Operating radius (m)	72.0 m Boom												Operating radius (m)
	36.0 m Jib			42.0 m Jib			48.0 m Jib			54.0 m Jib			
	Boom angle			Boom angle			Boom angle			Boom angle			
	86°	76°	66°	86°	76°	66°	86°	76°	66°	86°	76°	66°	
22.0	71.0			71.0									22.0
24.0	71.0			71.0			56.8						24.0
26.0	66.7			66.4			56.8			56.8			26.0
28.0	62.0			61.7			56.8			56.8			28.0
30.0	57.8			57.8			56.8			56.6			30.0
34.0	50.6			50.4			50.1			49.7			34.0
38.0	44.6			44.3			44.1			43.4			38.0
42.0	39.4	31.1		38.9	30.3		38.6			38.0			42.0
46.0		27.5		34.4	26.8		34.2	26.2		33.5			46.0
50.0		24.6			23.9		30.6	23.4		29.9	22.6		50.0
54.0		22.2			21.5		27.2	20.9		26.7	20.2		54.0
58.0			13.7		19.4			18.9		23.5	18.2		58.0
62.0			12.3		17.7	11.3		17.2			16.4		62.0
66.0			11.1			10.1		15.7	9.3		14.9		66.0
70.0						9.1			8.3		13.7	7.4	70.0
74.0						8.3			7.4			6.5	74.0
78.0									6.7				78.0
Reeves	6			6			5			5			Reeves

※ Designed and rated to comply with ANSI Code B30.5.

Ratings shown in are determined by the strength of the boom or other structural components.

Unit: metric ton

Operating radius (m)	72.0 m Boom						Operating radius (m)
	60.0 m Jib			66.0 m Jib			
	Boom angle			Boom angle			
86°	76°	66°	86°	76°	66°		
28.0	42.6						28.0
30.0	42.6			42.6			30.0
34.0	42.6			42.6			34.0
38.0	42.6			42.5			38.0
42.0	37.7			37.0			42.0
46.0	33.3			32.6			46.0
50.0	29.7	21.4		29.0			50.0
54.0	26.6	19.7		25.9	19.0		54.0
58.0	23.5	17.7		22.6	17.0		58.0
62.0	20.7	16.0		18.5	15.3		62.0
66.0	18.8	14.5		14.7	13.7		66.0
70.0		13.2			12.3		70.0
74.0		12.0			11.1		74.0
78.0		10.9			10.0		78.0
82.0					9.1		82.0
Reeves	4			4			Reeves

※ Designed and rated to comply with ANSI Code B30.5.

Ratings shown in are determined by the strength of the boom or other structural components.

Working Ranges

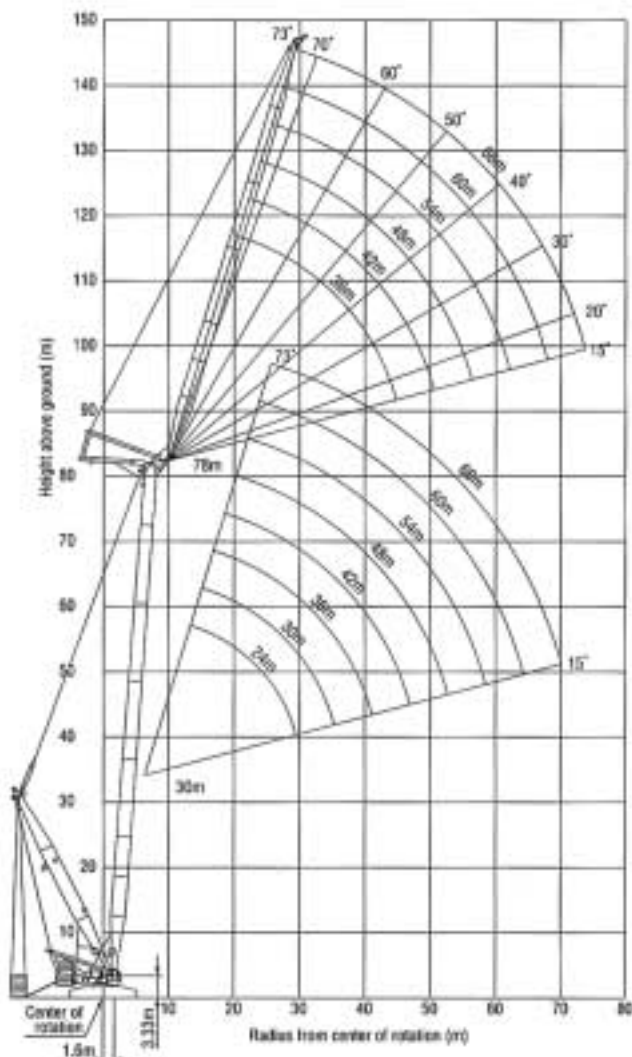

Boom Arrangement

Boom length	Boom arrangement
30 m	Base-A-A-T-Cap, Base-C-T-Cap
36 m	Base-A-C-T-Cap
42 m	Base-A-A-C-T-Cap, Base-C-C-T-Cap
48 m	Base-A-C-C-T-Cap
54 m	Base-A-A-C-C-T-Cap, Base-C-C-C-T-Cap
60 m	Base-A-C-C-C-T-Cap
66 m	Base-A-A-C-C-C-T-Cap, Base-C-C-C-C-T-Cap
72 m	Base-A-C-C-C-C-T-Cap
78 m	Base-A-A-C-C-C-C-T-Cap

Base = 9.0 m, Cap (Boom Cap) = 1.2 m
 Inserts: A = 6.0 m, B = 7.8 m, C = 12.0 m

Jib Arrangement

Jib length	Jib arrangement
24 m	Base-E-Jib tip
30 m	Base-E-E-Jib tip, Base-F-Jib tip
36 m	Base-E-F-Jib tip
42 m	Base-E-E-F-Jib tip, Base-F-F-Jib tip
48 m	Base-E-F-F-Jib tip
54 m	Base-E-E-F-F-Jib tip, Base-F-F-F-Jib tip
60 m	Base-E-F-F-F-Jib tip
66 m	Base-E-E-F-F-F-Jib tip

Base (jib base) = 9.0 m, Jib Tip (light-duty tip/Jib tip) = 9.0 m
 Inserts (jib): E (luffing jib insert) = 6.0 m, F (luffing jib insert) = 12.0 m

Luffing Boom and Jib Combinations

Boom Length	24 m jib	30 m jib	36 m jib	42 m jib	48 m jib	54 m jib	60m jib	66 m jib
30 m	○	○	○	○	○	○	○	○
36 m	×	○	○	○	○	○	○	○
42 m	×	○	○	○	○	○	○	○
48 m	×	○	○	○	○	○	○	○
54 m	×	○	○	○	○	○	○	○
60 m	×	×	○	○	○	○	○	○
66 m	×	×	○	○	○	○	○	○
72 m	×	×	○	○	○	○	○	○
78 m	×	×	○**	○**	○**	○**	○**	○**

× : All Luffing Jib Combinations Which is None.
 ○ : All Luffing Jib Combinations Which is Allowed.
 ○** : SHL Luffing Jib Combinations Which is Allowed.

SHL Luffing Jib Rated Charts

7350
MasterTech

(1) 30 m luffing jib rated loads in metric tons for 360° working area

(Counterweight 120 t + Carbody weight 41 t / Palette weight: 250 t x 13 m)

Unit: metric ton

Operating radius (m)	30.0 m Boom												Operating radius (m)
	24.0 m Jib			30.0 m Jib			36.0 m Jib			42.0 m Jib			
	Boom angle			Boom angle			Boom angle			Boom angle			
	66°	76°	66°	66°	76°	66°	66°	76°	66°	66°	76°	66°	
14.0	113.5												14.0
16.0	113.5			113.5									16.0
18.0	111.2			107.8			104.8						18.0
20.0	101.9			99.7			96.8			93.8			20.0
22.0	93.4			90.7			88.8			87.4			22.0
24.0	86.5	90.5		83.3			81.0			79.4			24.0
26.0	80.2	82.2		77.0	81.4		74.5			72.7			26.0
28.0	73.4	75.2		71.8	74.4		68.9			66.9			28.0
30.0		69.3		67.1	68.5		64.1	67.4		62.0			30.0
34.0		59.5	58.6	57.8	58.9		56.5	57.9		53.9	57.3		34.0
38.0			51.2		51.5	50.4	49.8	50.6		47.7	49.9		38.0
42.0						44.7		44.7	43.5	42.9	44.1		42.0
46.0								40.0	38.9	33.0	39.4	38.2	46.0
50.0									35.1		35.5	34.3	50.0
54.0												31.2	54.0
Reeves	9			9			9			8			Reeves

⊞ Designed and rated to comply with ANSI Code B30.5.

Ratings shown in are determined by the strength of the boom or other structural components.

Unit: metric ton

Operating radius (m)	30.0 m Boom												Operating radius (m)
	48.0 m Jib			54.0 m Jib			60.0 m Jib			66.0 m Jib			
	Boom angle			Boom angle			Boom angle			Boom angle			
	66°	75°	66°	66°	75°	66°	66°	75°	66°	66°	75°	66°	
22.0	82.6												22.0
24.0	77.9			71.3									24.0
26.0	71.0			67.7			61.4						26.0
28.0	65.1			63.8			58.4			53.0			28.0
30.0	60.0			58.4			55.6			50.5			30.0
34.0	51.6	56.6		49.8			48.0			45.8			34.0
38.0	45.1	49.2		43.2	48.7		41.2			39.4			38.0
42.0	40.0	43.4		37.8	42.8		35.7	42.2		33.8	41.3		42.0
46.0	36.0	38.6	37.3	33.5	38.0		31.2	37.4		29.2	36.5		46.0
50.0	32.9	34.7	33.5	30.0	34.1	32.8	27.6	33.4		25.4	32.5		50.0
54.0		31.4	30.3	27.3	30.8	29.6	24.5	30.1	28.9	22.2	29.2		54.0
58.0			27.6	22.6	28.0	26.8	22.1	27.3	26.1	19.6	28.3	25.1	58.0
62.0			25.3		25.6	24.5	20.2	24.7	23.7	17.4	23.2	22.8	62.0
66.0						22.5		21.9	21.7	15.7	20.5	20.7	66.0
70.0									19.9	14.6	18.2	19.0	70.0
74.0									18.4		16.2	17.4	74.0
78.0												16.0	78.0
Reeves	7			6			5			4			Reeves

⊞ Designed and rated to comply with ANSI Code B30.5.

Ratings shown in are determined by the strength of the boom or other structural components.

SHL Luffing Jib Rated Charts

7350
MasterTech

(2) 42 m luffing jib rated loads in metric tons for 360° working area
(Counterweight 120 t + Carbody weight 41 t / Palette weight: 250 t x 13 m)

Unit: metric ton

Operating radius (m)	42.0 m Boom												Operating radius (m)
	30.0 m Jib			36.0 m Jib			42.0 m Jib			48.0 m Jib			
	Boom angle			Boom angle			Boom angle			Boom angle			
	86°	76°	66°	66°	76°	86°	66°	76°	86°	76°	66°		
18.0	113.5												18.0
20.0	106.9			99.4			98.3						20.0
22.0	95.9			94.9			92.4			84.1			22.0
24.0	86.3			85.3			84.9			79.5			24.0
26.0	78.3			77.4			76.9			75.2			26.0
28.0	71.6			70.7			70.2			69.7			28.0
30.0	65.8	65.2		64.9			64.5			64.0			30.0
34.0	56.5	56.0		55.7	54.8		55.2	54.2		54.7			34.0
38.0		48.9		48.6	47.8		48.1	47.1		47.5	46.4		38.0
42.0		43.2	40.6		42.2		42.4	41.5		41.8	40.8		42.0
46.0			36.2		37.6	35.0	37.9	37.0		37.2	36.2		46.0
50.0			32.7			31.5		33.2	30.7	33.4	32.4		50.0
54.0						28.6		30.1	27.7		29.3	26.6	54.0
58.0									25.3		26.6	24.3	58.0
62.0									23.2			22.2	62.0
66.0												20.4	66.0
Reeves		9			8			8			7		Reeves

⊞ Designed and rated to comply with ANSI Code B30.5.

Ratings shown in are determined by the strength of the boom or other structural components.

Unit: metric ton

Operating radius (m)	42.0 m Boom									Operating radius (m)
	54.0 m Jib			60.0 m Jib			66.0 m Jib			
	Boom angle			Boom angle			Boom angle			
	86°	76°	66°	86°	76°	66°	86°	76°	66°	
24.0	71.0									24.0
26.0	68.6			62.3						26.0
28.0	65.2			59.2			53.7			28.0
30.0	62.0			56.3			51.1			30.0
34.0	54.3			51.0			46.3			34.0
38.0	47.1			46.4			42.1			38.0
42.0	41.4	40.2		40.8			38.4			42.0
46.0	36.7	35.6		35.3	35.0		33.3	34.0		46.0
50.0	32.7	31.8		30.8	31.2		29.0	30.3		50.0
54.0	28.7	28.7		27.0	28.0		25.4	27.1		54.0
58.0	22.6	26.0	23.6	23.8	25.3	22.9	22.3	24.4		58.0
62.0		23.7	21.5	21.1	23.0	20.7	19.7	22.1	19.7	62.0
66.0		21.7	19.6		21.0	18.8	17.5	20.0	17.8	66.0
70.0			18.0		19.2	17.2	15.3	18.3	16.2	70.0
74.0						15.7		16.8	14.7	74.0
78.0						14.5		15.0	13.5	78.0
82.0									12.4	82.0
Reeves		6			5			5		Reeves

⊞ Designed and rated to comply with ANSI Code B30.5.

Ratings shown in are determined by the strength of the boom or other structural components.

SHL Luffing Jib Rated Charts

7350
MasterTech

(3) 54 m luffing jib rated loads in metric tons for 360° working area
(Counterweight 120 t + Carbody weight 41 t / Palette weight: 250 t x 13 m)

Unit: metric ton

Operating radius (m)	54.0 m Tower Boom												Operating radius (m)
	30.0 m Jib			36.0 m Jib			42.0 m Jib			48.0 m Jib			
	Boom angle			Boom angle			Boom angle			Boom angle			
	86°	76°	66°	86°	76°	66°	86°	76°	66°	86°	76°	66°	
18.0	85.2												18.0
20.0	85.2			85.2									20.0
22.0	85.2			85.2			71.0						22.0
24.0	84.6			83.6			71.0			71.0			24.0
26.0	78.7			75.8			71.0			71.0			26.0
28.0	70.1			69.2			68.6			68.3			28.0
30.0	64.4			63.5			63.1			62.6			30.0
34.0	55.3	52.6		54.4			54.0			53.4			34.0
38.0		45.8		47.4	44.7		46.9	44.0		46.4			38.0
42.0		40.5		39.5	39.3		41.3	38.7		40.7	37.9		42.0
46.0		35.1	32.1		35.0		36.8	34.3		36.2	33.6		46.0
50.0			28.8		31.5	27.5		30.8		32.4	30.0		50.0
54.0			26.1			24.8		27.8	24.0	26.2	27.0		54.0
58.0						22.6		25.3	21.7		24.5	20.8	58.0
62.0									19.8		22.3	18.9	62.0
66.0									18.2			17.2	66.0
70.0												15.8	70.0
Reeves	7			7			6			6			Reeves

⚠ Designed and rated to comply with ANSI Code B30.5.

Ratings shown in are determined by the strength of the boom or other structural components.

Unit: metric ton

Operating radius (m)	54.0 m Boom									Operating radius (m)
	54.0 m Jib			60.0 m Jib			66.0 m Jib			
	Boom angle			Boom angle			Boom angle			
	86°	76°	66°	86°	76°	66°	86°	76°	66°	
26.0	69.9			56.8						26.0
28.0	66.3			56.8			54.4			28.0
30.0	62.3			56.8			51.7			30.0
34.0	53.1			51.7			46.9			34.0
38.0	46.0			45.0			42.6			38.0
42.0	40.3			39.4			38.7			42.0
46.0	35.7	33.0		34.8	31.8		34.1			46.0
50.0	31.9	29.4		31.0	28.3		29.6	27.8		50.0
54.0	28.8	26.4		27.4	25.3		25.9	24.8		54.0
58.0	25.7	23.8		24.1	22.7		22.7	22.2		58.0
62.0		21.7	18.1	21.2	20.6		20.0	20.0		62.0
66.0		19.8	16.4		18.7	15.3	17.7	18.1		66.0
70.0			15.0		17.1	13.8	15.6	16.4	13.1	70.0
74.0			13.7		15.7	12.5		15.0	11.6	74.0
78.0			12.6			11.4		13.7	10.7	78.0
82.0						10.4			9.7	82.0
86.0									8.6	86.0
90.0									8.1	90.0
Reeves	6			5			5			Reeves

⚠ Designed and rated to comply with ANSI Code B30.5.

Ratings shown in are determined by the strength of the boom or other structural components.

(4) 66 m luffing jib rated loads in metric tons for 360° working area
(Counterweight 120 t + Carbody weight 41 t / Palette weight: 250 t x 13 m)

Unit: metric ton

Operating radius (m)	66.0 m Boom												Operating radius (m)
	36.0 m Jib			42.0 m Jib			48.0 m Jib			54.0 m Jib			
	Boom angle			Boom angle			Boom angle			Boom angle			
	86°	76°	66°	86°	76°	66°	86°	76°	66°	86°	76°	66°	
20.0	71.0												20.0
22.0	71.0			71.0									22.0
24.0	71.0			71.0			56.8						24.0
26.0	71.0			71.0			56.8			56.8			26.0
28.0	67.4			67.0			56.8			56.8			28.0
30.0	61.9			61.5			56.8			56.8			30.0
34.0	52.9			52.5			52.0			51.7			34.0
38.0	46.0	40.9		45.6			45.0			44.7			38.0
42.0	40.5	35.9		40.1	35.2		39.3			39.1			42.0
46.0		31.8		35.6	31.2		35.0	30.4		34.6	29.8		46.0
50.0		28.5			27.8		31.3	27.1		30.9	26.5		50.0
54.0		25.8	20.4		25.0		26.8	24.3		27.8	23.7		54.0
58.0			18.4		22.7	17.6		21.9		25.1	21.3		58.0
62.0			16.7			15.9		19.9	14.9		19.2		62.0
66.0			15.3			14.4		18.2	13.5		17.5	12.7	66.0
70.0						13.2				12.2	16.0	11.5	70.0
74.0										11.1		10.3	74.0
78.0												9.4	78.0
82.0												8.5	82.0
Reeves		0			0			0			0		Reeves

⊗ Designed and rated to comply with ANSI Code B30.5.

Ratings shown in are determined by the strength of the boom or other structural components.

Unit: metric ton

Operating radius (m)	66.0 m Boom						Operating radius (m)
	60.0 m Jib			66.0 m Jib			
	Boom angle			Boom angle			
	86°	76°	66°	86°	76°	66°	
28.0	56.8						28.0
30.0	56.8			42.6			30.0
34.0	51.3			42.6			34.0
38.0	44.3			42.6			38.0
42.0	38.7			37.9			42.0
46.0	34.2			33.3			46.0
50.0	30.4	25.8		29.6			50.0
54.0	27.3	23.0		26.4	22.0		54.0
58.0	24.6	20.6		23.1	19.6		58.0
62.0	21.8	18.6		20.3	17.6		62.0
66.0	17.9	16.8		18.0	15.8		66.0
70.0		15.2	10.7	15.9	14.3		70.0
74.0		13.9	9.5		12.9	8.5	74.0
78.0		12.7	8.5		11.7	7.5	78.0
82.0			7.7		10.7		82.0
86.0			6.9				86.0
Reeves		5			4		Reeves

⊗ Designed and rated to comply with ANSI Code B30.5.

Ratings shown in are determined by the strength of the boom or other structural components.

SHL Luffing Jib Rated Charts

7350
MasterTech

(5) 78 m luffing jib rated loads in metric tons for 360° working area
(Counterweight 120 t + Carbody weight 41 t / Palette weight: 250 t x 13 m)

Unit: metric ton

Operating radius (m)	78.0 m Boom												Operating radius (m)
	36.0 m Jib			42.0 m Jib			48.0 m Jib			54.0 m Jib			
	Boom angle			Boom angle			Boom angle			Boom angle			
	86°	76°	66°	86°	76°	66°	86°	76°	66°	86°	76°	66°	
22.0	56.8												22.0
24.0	56.8			56.8									24.0
26.0	54.3			53.8			53.3			42.6			26.0
28.0	50.4			50.0			49.4			42.6			28.0
30.0	46.8			46.5			46.0			42.6			30.0
34.0	40.9			40.7			40.2			39.8			34.0
38.0	35.9			35.9			35.5			35.1			38.0
42.0	31.7	33.6		31.9			31.5			31.1			42.0
46.0		29.8		28.4	29.2		28.2	28.0		27.6			46.0
50.0		26.6		25.3	26.1		25.3	24.9		25.0	23.8		50.0
54.0		24.0			23.4		22.6	22.3		22.5	21.2		54.0
58.0		21.7			21.2			20.0		20.2	19.0		58.0
62.0			13.6		19.2	12.9		18.1			17.1		62.0
66.0			12.3			11.6		16.5	10.4		15.5		66.0
70.0			11.2			10.5			9.3		14.0		70.0
74.0						9.5			8.3		12.8		74.0
78.0									7.4				78.0
82.0									6.7				82.0
Reeves		5			5			5			4		Reeves

⚠ Designed and rated to comply with ANSI Code B30.5.

Ratings shown in are determined by the strength of the boom or other structural components.

Unit: metric ton

Operating radius (m)	78.0 m Boom						Operating radius (m)
	60.0 m Jib			66.0 m Jib			
	Boom angle			Boom angle			
	86°	76°	66°	86°	76°	66°	
28.0	42.6						28.0
30.0	42.6			42.6			30.0
34.0	39.2			38.6			34.0
38.0	34.6			34.1			38.0
42.0	30.7			30.2			42.0
46.0	27.5			27.0			46.0
50.0	24.7			24.2			50.0
54.0	22.3	20.6		21.8	19.6		54.0
58.0	20.1	18.4		19.7	17.4		58.0
62.0	18.2	16.5		17.8	15.5		62.0
66.0	16.4	14.8		16.1	13.9		66.0
70.0		13.4			12.4		70.0
74.0		12.1			11.2		74.0
78.0		11.0			10.0		78.0
82.0					9.0		82.0
86.0					8.2		86.0
Reeves		4			4		Reeves

⚠ Designed and rated to comply with ANSI Code B30.5.

Ratings shown in are determined by the strength of the boom or other structural components.

Assembly & Transportation

7350 Standard Crane Self Assembly

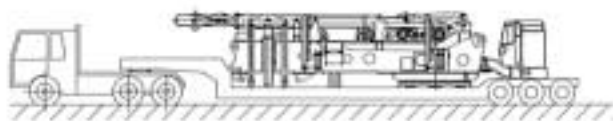

Upper-machine carry by a trailer

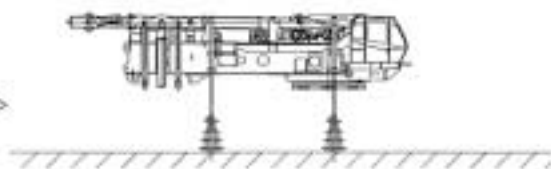

Lift the Upper Trans-Lifter

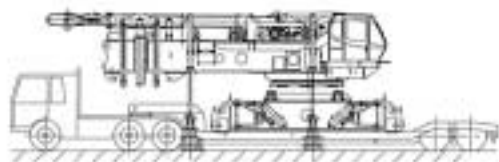

Carbody carry by a trailer

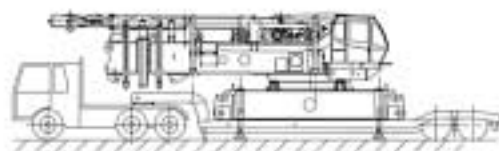

Assembled upper-machine and carbody by quick connection

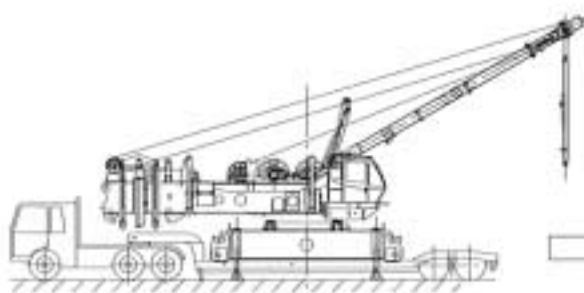

Rise the mast

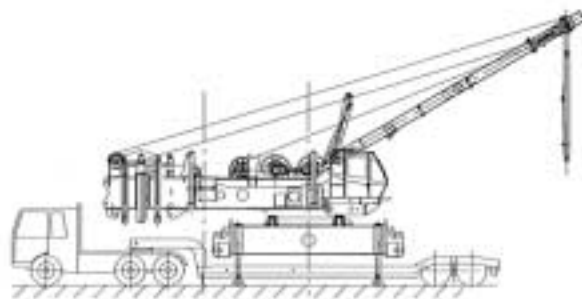

Lift the lower Trans-Lifter

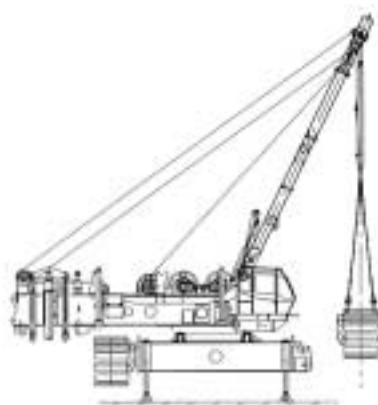

Install the crawler



Install the carbody weight

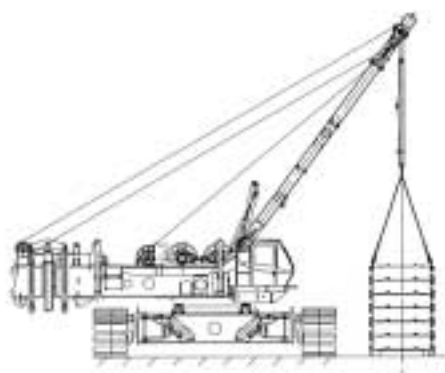

Assemble the counterweights

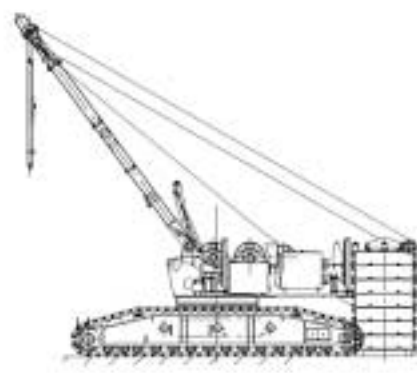

Lift the counterweight assembly



Assemble the attachment

Assembly & Transportation

Weight and Measurement for Transportation

Base Machine

Upper Frame

Weight: 60.0 ton x 1
Dimension: 13,408 mm (L) X 2,700 mm (H) X 3,000 mm (W)

Includes front winch, rear winch, boom hoist winch, mast, self-erection device, upper and lower removal device, upper Trans-lifter, and counterweight removal device.

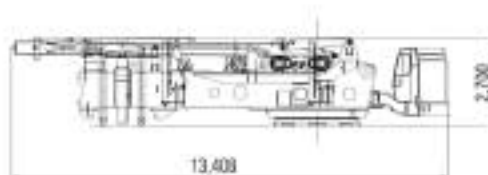

Carbody

Weight: 26.2 ton x 1
Dimension: 6,900 mm (L) X 1,434 mm (H) X 3,000 mm (W)

Includes upper and lower removal device and lower Trans-lifter.

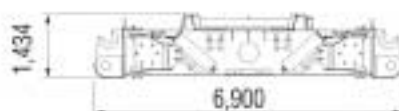

Crawlers

Weight: 36.2 ton x each side
Dimension: 10,497 mm (L) X 1,770 mm (H) X 2,017 mm (W)

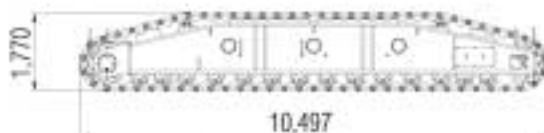

Hoist Winch Unit

Weight: 2.08 ton x 2 (front and rear)

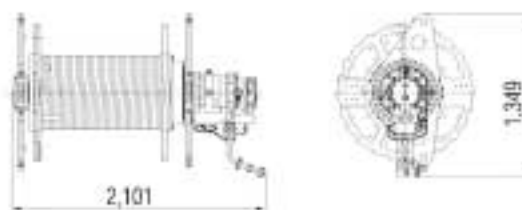

Boom hoist winch

Weight: 2.029 ton

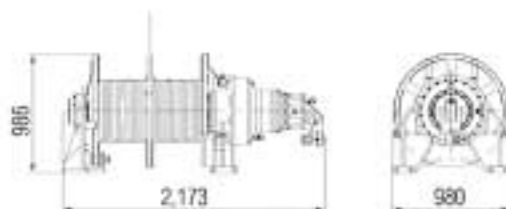

Jib hoist winch

Weight: 2.691 ton x 2

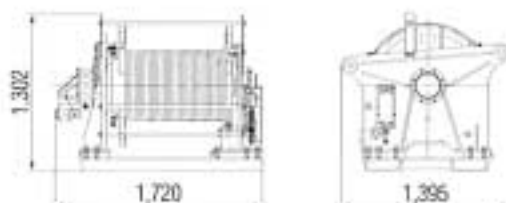

Mast

Weight: 6.29 ton

Include self-erection device and guy cable.

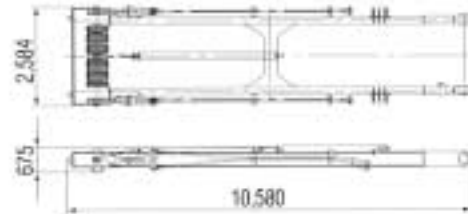

Counterweight Base

Weight: 20.0 ton

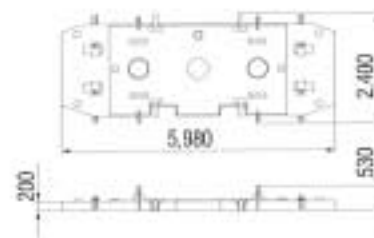

Counterweight

Weight: (A) 10.0 ton x 12
(B) 7.5 ton x 2

*the counterweight (B) of figures

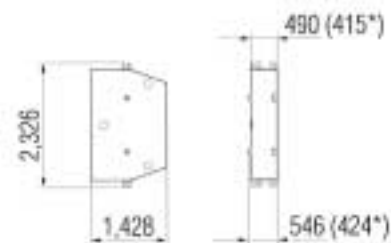

Carbody Counterweight

Weight: 20.0 ton x 2



Platform

Weight: 0.328 ton x 7



Weight and Measurement for Transportation

Attachment

Description	Width x Height x Length (mm)	Weight (metric ton)	Remarks
Hook			
350-ton/250-ton hook	1,323 x 3,120 x 970	6.05	
120-ton hook	960 x 2,270 x 800	3.5	
70-ton hook	760 x 2,122 x 900	3.1	
40-ton hook	700 x 1,181 x 900	2.0	
13.5-ton ball hook	400 dia. x 1,350	0.65	
Boom, Jib, Aux. Sheave			
Lower boom	3,000 x 3,219 x 9,313	11.4	Including cable reel, back stop, jib hoist winch
6 m insert boom	2,884 x 2,380 x 6,176	2.2	2 pieces
12 m insert boom	2,884 x 2,380 x 12,176	3.9	4 pieces
Boom cap	2,554 x 2,798 x 4,530	5.89	Including aux. sheave
7.8 m tapered insert boom	2,555 x 2,860 x 7,976	3.3	Including hydraulic oil tank
6 m tapered insert boom	2,680 x 2,481 x 6,158	1.63	Light-duty boom only use.
Lower jib	2,340 x 1,720 x 9,210	1.9	
6 m insert jib	2,516 x 1,990 x 6,140	1.3	Compatible with upper boom of light-duty boom.
12 m insert jib	2,516 x 1,990 x 12,140	2.4	Compatible with upper boom of light-duty boom.
Light-duty tip (Jib tip)	2,516 x 1,990 x 9,218	2.8	Compatible with upper boom of light-duty boom.
Lower mast	2,700 x 2,745 x 9,337	11.01	
12 m insert mast	2,584 x 2,425 x 12,176		
Upper mast	2,584 x 675 x 10,580	6.3	
Jib backstop, sheave, etc.			
Jib backstop	3,365	0.097	
Aux. sheave for jib	809 x 773 x 2,408	0.424	
Upper spreader for SHL	870 x 671 x 1,598	0.763	
Jib tip roller	1,434 x 1,445 x 1,810	0.704	
Hook sheave (upper)	755 x 1,355 x 2,560	1.36	
Hook sheave (lower)	740 x 1,245 x 1,306	1.36	
Palette for SHL			
Palette base	2,400 x 711 x 6,520	6.9	
Weight	546 x 2,326 x 1,428	10	24 pieces
Connecting beam	2,091 x 290 x 5,230	0.79	

NOTE: Due to our policy of continual product improvement, all designs and specifications are subject to change without advance notice.

KOBELCO CONSTRUCTION MACHINERY CO., LTD.

17-1, Higashigotanda 2-chome, Shinagawa-ku, Tokyo, 141-8626, JAPAN
 Tel: ++81 (0) 3-5789-2126 Fax: ++81 (0) 3-5789-2134