



## ROUGH TERRAIN CRANE RT 230-1 XL

DATASHEET - IMPERIAL



# RT 230-1 XL

### Features:

- ▶ Rated capacity:  
30 ton @ 10 ft working radius
- ▶ Maximum boom length:  
100 ft
- ▶ Maximum tip height:  
140 ft

**WORKS FOR YOU.™**

## Key

.....	3
-------	---

## Dimensions









































Crane dimensions .....	4
Crane weights .....	5

## Load Charts

Range Diagram – Main Boom – Outriggers fully extended (100%) .....	6
Load Chart – Main Boom – Outriggers fully extended (100%) .....	7
Range Diagram – Main Boom – Outriggers fully retracted (0%) .....	8
Load Chart – Main Boom – Outriggers fully retracted (0%) .....	9
Range Diagram – Main Boom – 26 ft offsettable jib .....	10
Load Chart – Main Boom – 26 ft offsettable jib .....	11
Range Diagram – Main Boom – 43 ft offsettable jib .....	12
Load Chart – Main Boom – 43 ft offsettable jib .....	13
Range Diagram – Main Boom – On tires .....	14
Load Chart – Main Boom – On tires .....	15

## Technical Description

Boom .....	16
Hoist, rope and hook .....	16, 17
Superstructure .....	17
Cab, controls, operator aids and load limiter / load indicator .....	17, 18
Carrier, engine, drive-line and hydraulic system .....	18
Vehicle performance .....	19
Tires .....	19

	Counterweight		General performance
	Main boom		Telescoping mode
	Boom length		Boom luffing angle
	Tip height		Working radius
	Boom with extension		Max. boom length with extension
	Main boom with aux head		Distance from the hook to the head sheave pin
	Slewing / Allowable slewing range		Slewing locked / Slewing locked at specified position
	Slewing brake		Slewing gears
	Outriggers / Lifting on outriggers (100/50/0% extended)		Lifting on wheels / Pick & Carry
	Main hoist		Auxiliary hoist
	Hoist speed		Rope length
	Rope – Standard / Optional		Max. line pull
	Rope diameter		Tire
	Hook block		Controls
	Cab		Engine
	Operator aids / Load limiter / Load indicator		Steering
	Mechanical transmission		Speed
	Hydraulics		Heating / Air conditioning
	Working temperature		Gradeability
	Lights		Gross vehicle weight
	Crane / Crane in standard configuration		Weight on front axle
	Crane without counterweight		Weight on rear axle

# CRANE DIMENSIONS

## RT 230-1 XL

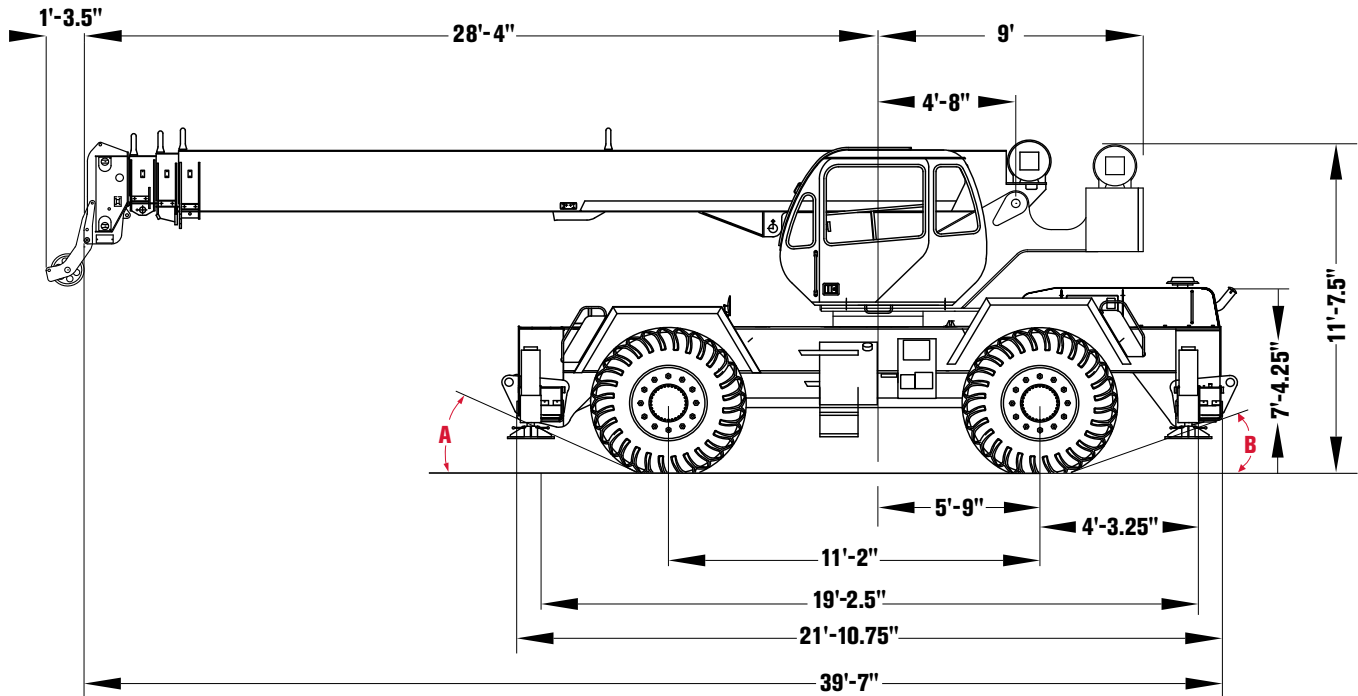

Tire Variances	16.00 x 25	20.5 x 25
A (Approach Angle)	25.1°	25.1°
B (Departure Angle)	23.1°	23.1°
C (Tire Track)	6'-7.5"	6'-10.5"
D (Overall Width)	8'	8'-8"

**Note:**

All heights are based on 16.00 x 25 tires.

Outrigger Spread	
From Jack CL to Jack CL	
Fully Extended	19'
Mid-Position	13'-2"
Fully Retracted	7'-4.5"

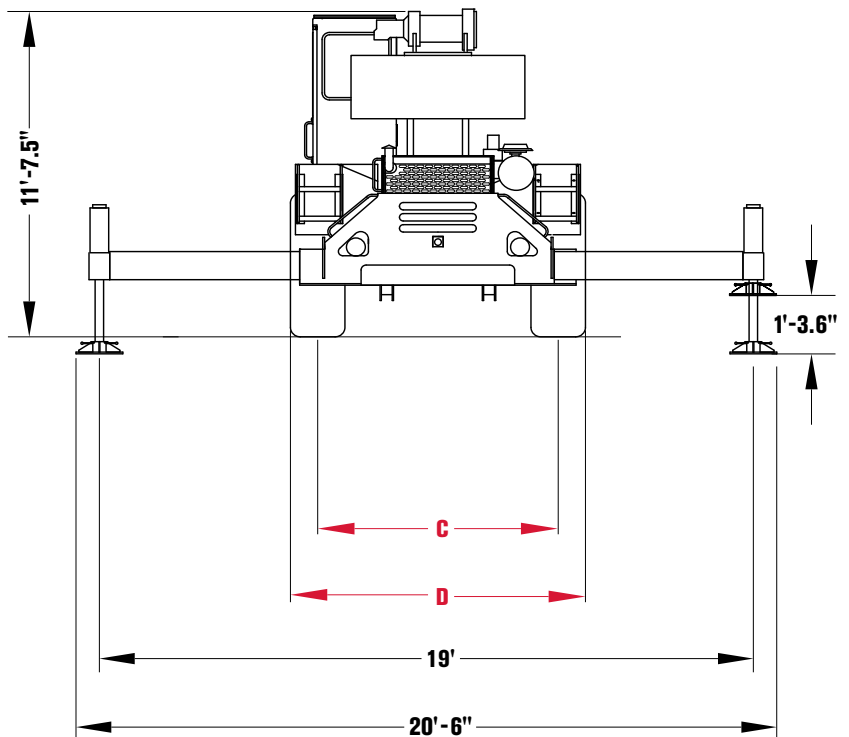

# CRANE WEIGHTS

**RT 230-1 XL**

## Approximate Weights

		↓ GVW	↑	↑
		55,930 lb	28,972 lb	26,958 lb
Add / Subtract for main optional equipment				
	26 ft to 43 ft swing on jib stowed	+ 1500 lb	+ 2600 lb	- 1100 lb
	Auxiliary boom head	+ 100 lb	+ 300 lb	- 200 lb
	Auxiliary hoist*	+ 115 lb	- 25 lb	+ 140 lb
	4 sheaves, 30T	+ 655 lb	+ 1071 lb	- 416 lb
	3 sheaves, 30T	+ 670 lb	+ 1099 lb	- 429 lb
	2 sheaves, 25T	+ 682 lb	+ 1117 lb	- 435 lb
	7T Hookball	+ 240 lb	+ 290 lb	- 50 lb

NOTE: Values are subject to 2% variation

\* Weight includes rope

# RANGE DIAGRAM - MAIN BOOM

**RT 230-1 XL**

**Outriggers Fully Extended (100%)**

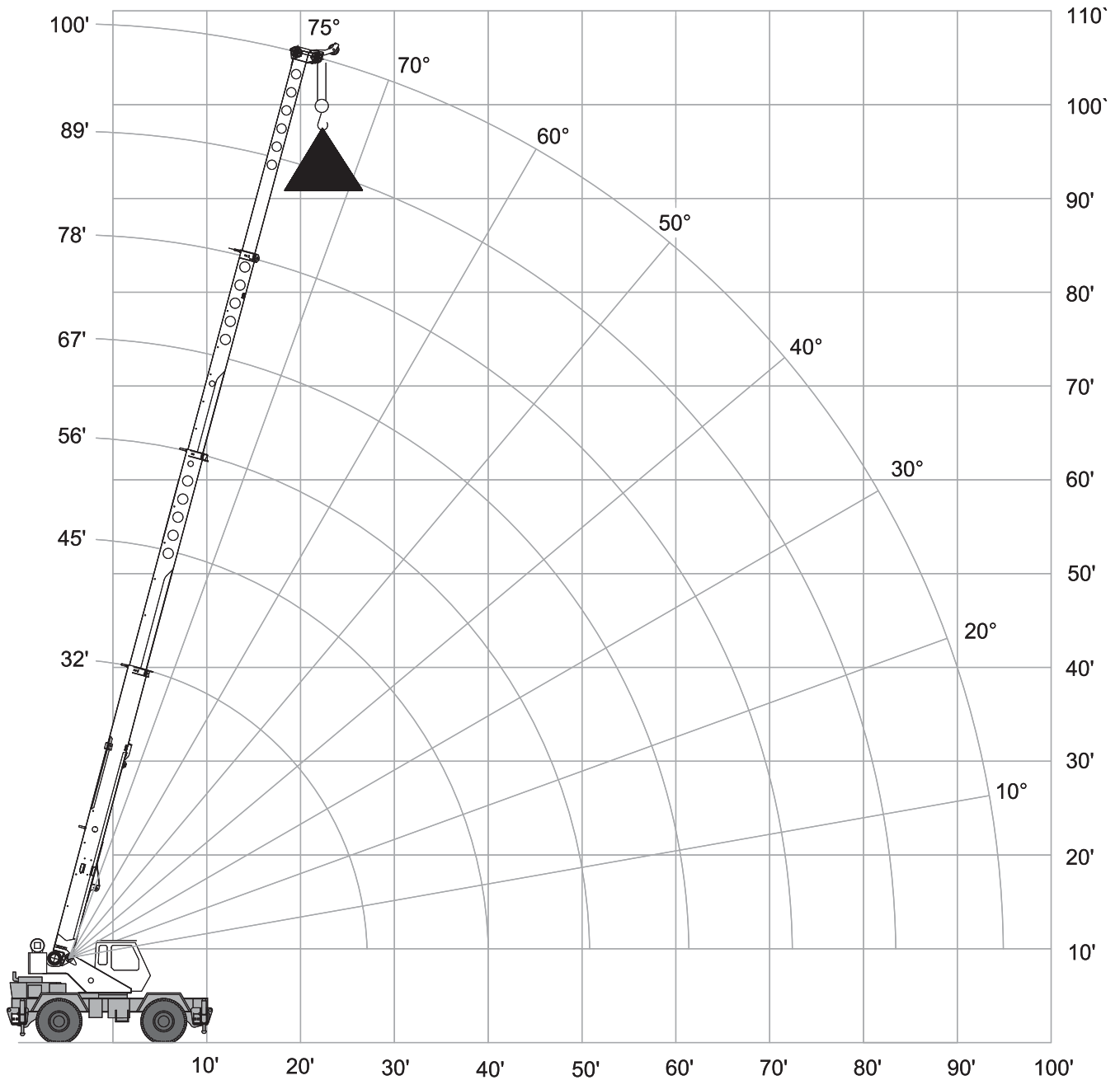
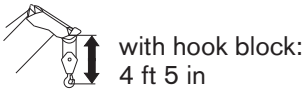
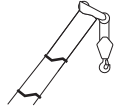



# LOAD CHART – MAIN BOOM

**RT 230-1 XL**

## Outriggers Fully Extended (100%)



Standard ASME B30.5

	Boom Length							
	32.29 ft	44.79 ft	55.79 ft	66.79 ft	77.79 ft	88.79 ft	99.79 ft	
ft	lbs	lbs	lbs	lbs	lbs	lbs	lbs	ft
10	60,000	46,500						10
12	48,900	45,100	43,000					12
15	42,500	39,100	37,100	35,700				15
20	30,000	30,900	30,300	29,000	26,900			20
25	22,400	23,400	23,800	24,100	22,600	20,300	15,000	25
30	19,300	18,400	18,800	19,100	19,300	17,400	12,800	30
35		13,800	14,300	14,500	14,700	14,800	11,100	35
40		10,400	11,100	11,300	11,500	11,600	9,700	40
45			8,700	9,000	9,200	9,300	8,600	45
50			6,900	7,300	7,500	7,600	7,600	50
55				5,900	6,100	6,200	6,300	55
60				4,700	5,000	5,100	5,200	60
65					4,100	4,200	4,300	65
70					3,300	3,500	3,600	70
75							2,900	75
80							2,400	80
85							1,900	85
90							1,400	90
95							1,000	95

## Notes to lifting capacity

Lifting capacities do not exceed 85% of tipping load. Weight of hook blocks and slings is part of the load, and is to be deducted from the capacity ratings. Consult operation manual for further details.

Note: Data published herein is intended as a guide only and shall not be construed to warrant applicability for lifting purposes. Crane operation is subject to the computer charts and operation manual both supplied with the crane.

# RANGE DIAGRAM - MAIN BOOM

**RT 230-1 XL**

**Outriggers Fully Retracted (0%)**

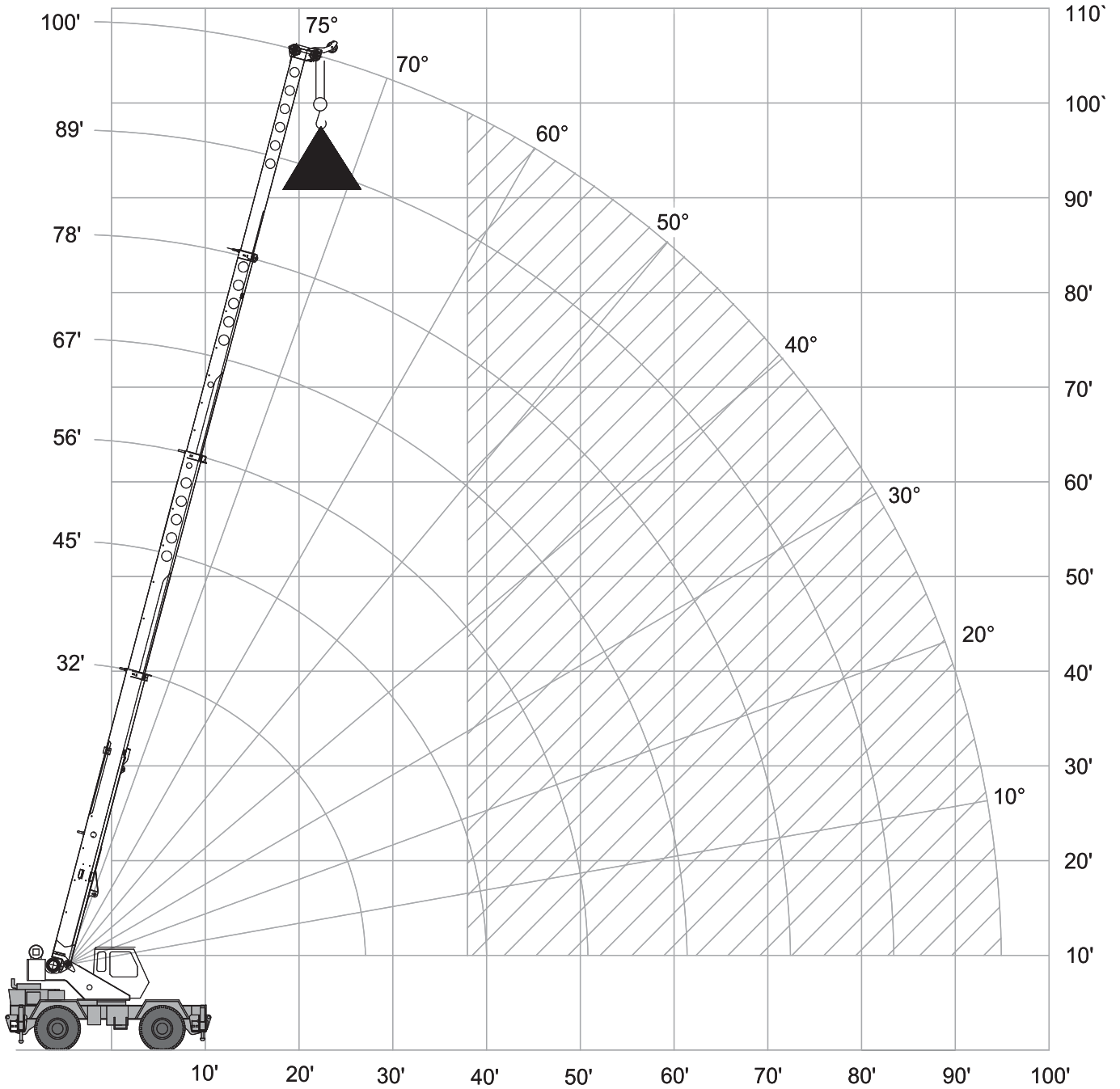
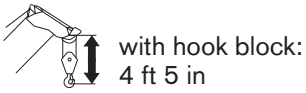
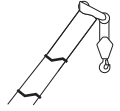



# LOAD CHART – MAIN BOOM

**RT 230-1 XL**

## Outriggers Fully Retracted (0%)

 10,000 lbs

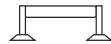
 7 ft 4.5 in (0%)

 360°

Standard ASME  
B30.5

	Boom Length							
	32.29 ft	44.79 ft	55.79 ft	66.79 ft	77.79 ft	88.79 ft	99.79 ft	
ft	lbs	lbs	lbs	lbs	lbs	lbs	lbs	ft
10	34,300	35,100						10
12	24,500	25,300	25,700					12
15	16,200	17,100	17,500	17,700				15
20	9,100	10,100	10,500	10,600	10,800			20
25	5,300	6,200	6,700	6,900	7,000	7,100	7,200	25
30	3,700	3,900	4,300	4,500	4,700	4,800	4,900	30
35		2,200	2,600	2,900	3,100	3,200	3,300	35
40		900	1,500	1,700	1,900	2,000	2,100	40
45				800	1,000	1,100	1,300	45

## Notes to lifting capacity

Lifting capacities do not exceed 85% of tipping load. Weight of hook blocks and slings is part of the load, and is to be deducted from the capacity ratings. Consult operation manual for further details.

Note: Data published herein is intended as a guide only and shall not be construed to warrant applicability for lifting purposes. Crane operation is subject to the computer charts and operation manual both supplied with the crane.

# RANGE DIAGRAM - MAIN BOOM

**RT230-1 XL**

**With Jib, 26 ft offset**

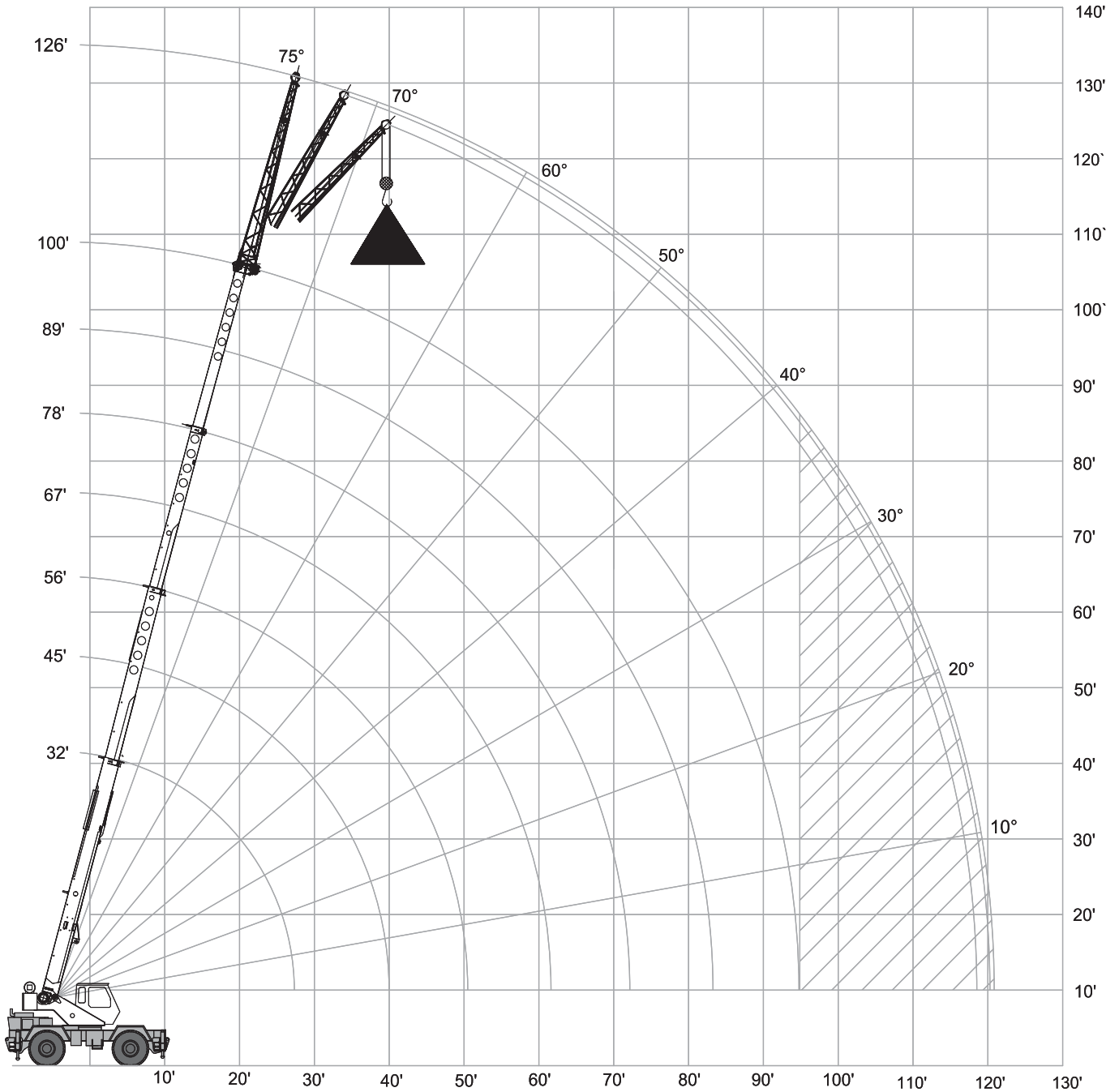
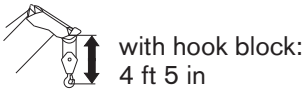
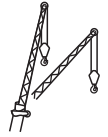

# LOAD CHART – MAIN BOOM

**RT 230-1 XL**

**With Jib, 26 ft offset**

 10,000 lbs

 19 ft (100%)

 360°

Standard ASME  
B30.5

26 ft Offsettable Jib					
0°		15°		30°	
 ft	lbs	 ft	lbs	 ft	lbs
37	9,000	43	7,300	47	5,500
41	8,500	46	6,700	51	5,200
44	8,000	50	6,200	55	4,900
50	7,200	55	5,500	60	4,400
56	6,200	60	5,000	65	4,000
61	5,400	65	4,400	70	3,600
66	3,900	70	3,800	74	3,200
73	3,000	77	3,100	80	2,700
80	2,400	84	2,500	86	2,200
86	1,900	90	1,900	92	1,700
93	1,400	96	1,400	98	1,300
100	900	102	900	103	900

## Notes to lifting capacity

Lifting capacities do not exceed 85% of tipping load. Weight of hook blocks and slings is part of the load, and is to be deducted from the capacity ratings. Consult operation manual for further details.

Note: Data published herein is intended as a guide only and shall not be construed to warrant applicability for lifting purposes. Crane operation is subject to the computer charts and operation manual both supplied with the crane.

# RANGE DIAGRAM - MAIN BOOM

**RT 230-1 XL**

**With Jib, 43 ft offset**

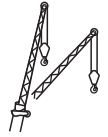

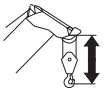
 with hook block:  
4 ft 5 in

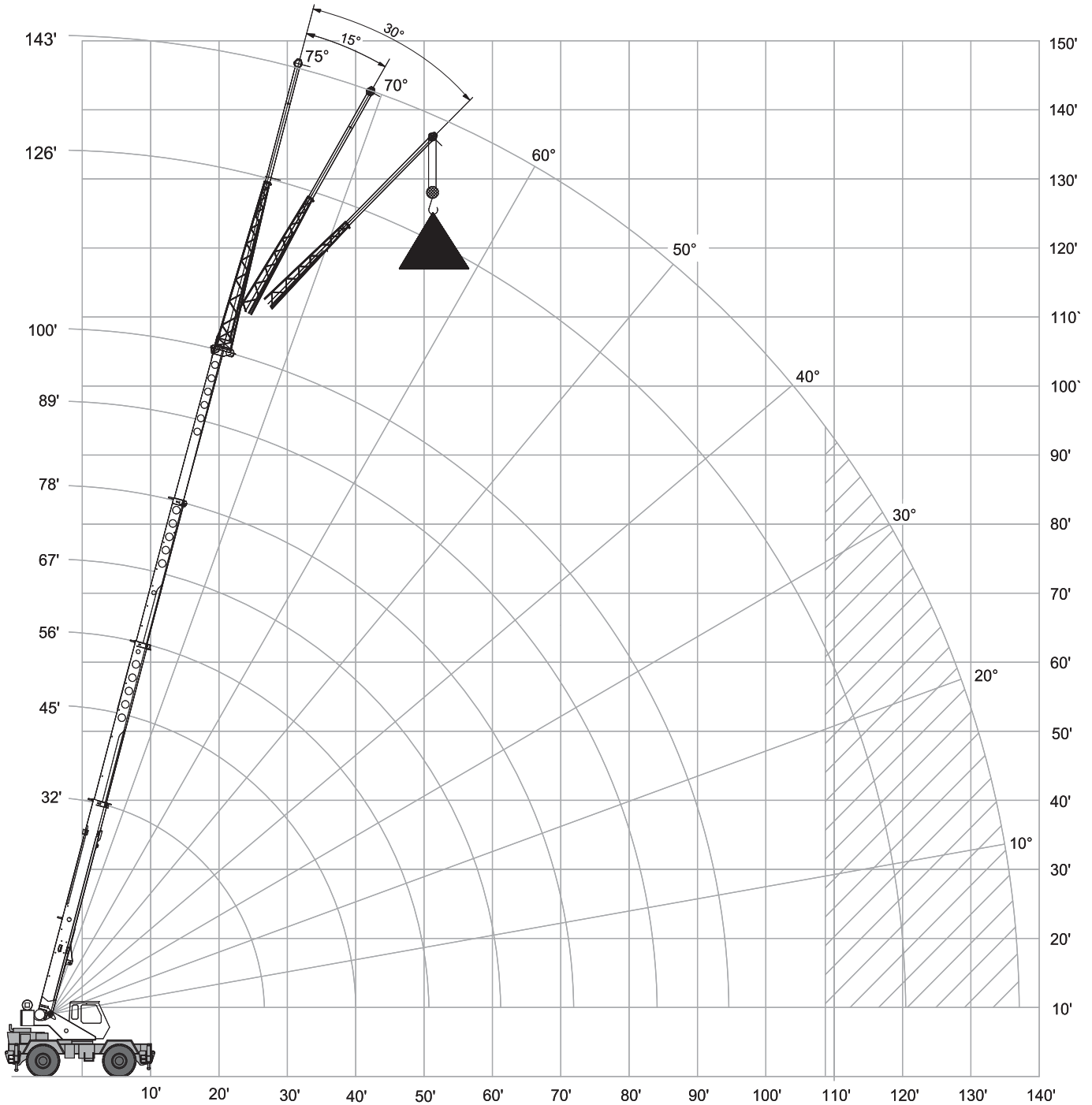

# LOAD CHART – MAIN BOOM

**RT 230-1 XL**



**With Jib, 43 ft offset**

 10,000 lbs

 19 ft (100%)

 360°

Standard ASME  
B30.5

43 ft Offsettable Jib					
0°		15°		30°	
 ft	lbs	 ft	lbs	 ft	lbs
41	5,000	51	3,300	59	2,600
46	4,700	56	3,200	63	2,600
51	4,400	61	3,100	67	2,500
58	4,000	67	2,900	74	2,400
64	3,700	74	2,800	80	2,400
70	3,500	79	2,700	85	2,300
76	3,300	85	2,600	90	2,300
83	2,800	91	2,500	96	2,200
90	2,200	98	2,000	102	1,900
98	1,800	106	1,600	108	1,500
106	1,300	112	1,200	114	1,100
115	900	119	800		

## Notes to lifting capacity

Lifting capacities do not exceed 85% of tipping load. Weight of hook blocks and slings is part of the load, and is to be deducted from the capacity ratings. Consult operation manual for further details.

Note: Data published herein is intended as a guide only and shall not be construed to warrant applicability for lifting purposes. Crane operation is subject to the computer charts and operation manual both supplied with the crane.

# RANGE DIAGRAM - MAIN BOOM

**RT 230-1 XL**

## On Tires

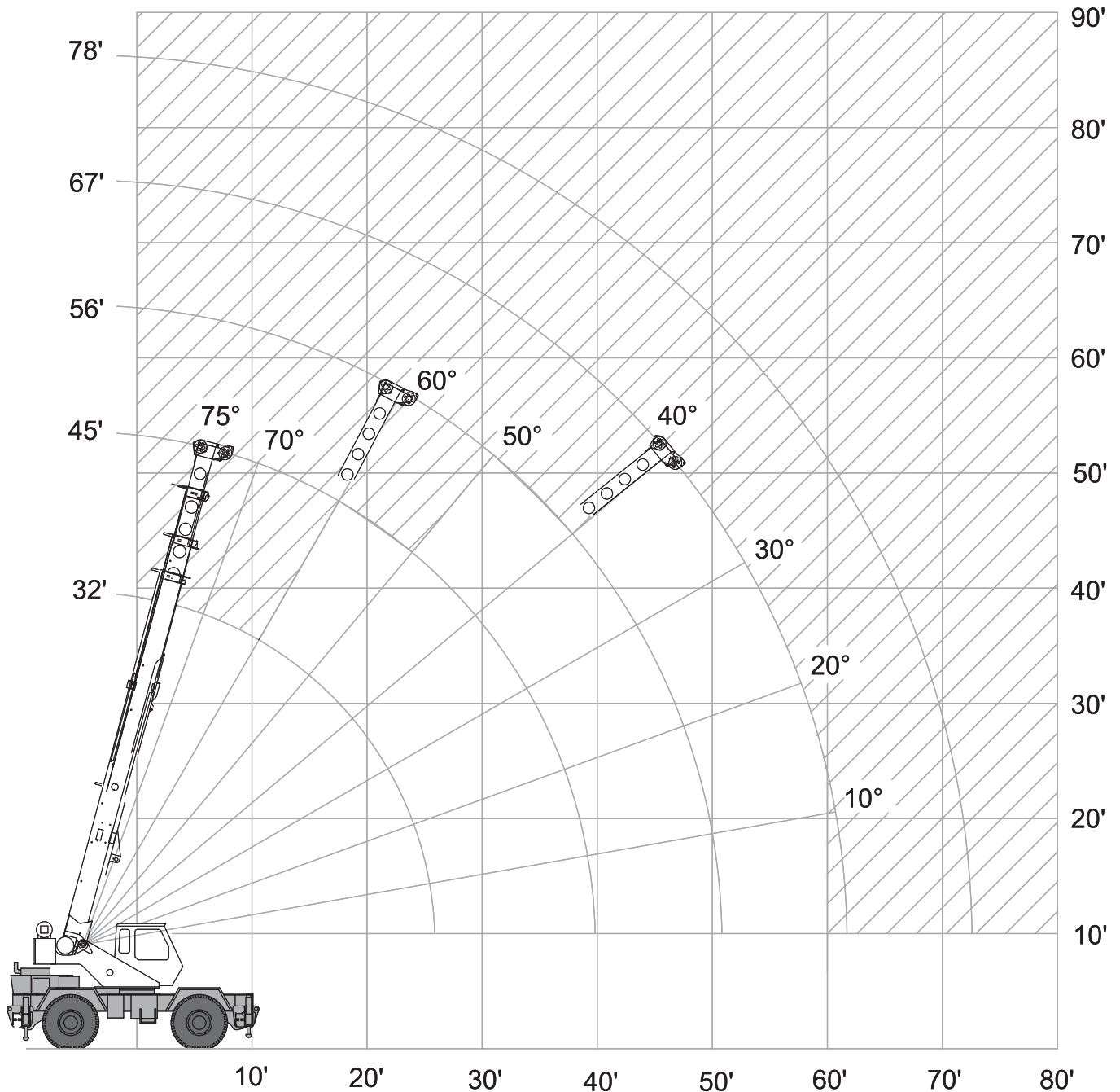
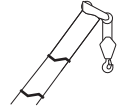
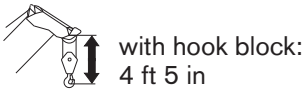

# LOAD CHART – MAIN BOOM

**RT230-1 XL**

## On Tires



10,000 lbs



360°

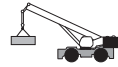

On tires  
20.50 x 25-24 PR

Standard ASME  
B30.5

Boom		Travel Speed Boom straight over front		
Radius	Length	0 mph	Creep	2.5 mph
ft	ft	lbs	lbs	lbs
10	32	26,600	34,300	23,300
12	32	19,900	29,400	19,700
15	32	13,900	23,900	15,600
20	45	8,100	17,400	11,000
25	45	5,300	11,000	7,800
30	45	3,400	7,700	5,600
35	56	2,100	5,900	4,300
40	56	1,300	4,500	3,300
45	56	700	3,500	2,500
50	67		2,700	1,800
55	67		2,000	1,300
60	67		1,400	800

## Notes to lifting capacity







Lifting capacities do not exceed 85% of tipping load. Weight of hook blocks and slings is part of the load, and is to be deducted from the capacity ratings. Consult operation manual for further details.

Note: Data published herein is intended as a guide only and shall not be construed to warrant applicability for lifting purposes. Crane operation is subject to the computer charts and operation manual both supplied with the crane.







# TECHNICAL DESCRIPTION

**RT 230-1 XL**

## Boom

Standard configuration:	
	4 sections hydraulic actuated boom
	Full power mechanically synchronized
	Min. / Max. <span style="float: right;">32 ft / 100 ft</span>
	Boom elevation angle range (min. / max.) <span style="float: right;">-4° / 76°</span>
Optional configuration:	
	Single sheave
	One section, side stowable Angular offsets <span style="float: right;">0, 15 and 30 degrees</span>
	With one section jib <span style="float: right;">120 ft</span> With two section jib <span style="float: right;">147 ft</span>







## Hoist, Rope and Hook

Standard configuration:	
	Grooved drum Storage capacity <span style="float: right;">598 ft</span>
	Two speed ratios Without load in 6th layer (low range / high range) <span style="float: right;">297 ft/min / 475 ft/min</span> Without load in 1st layer (low range / high range) <span style="float: right;">205 ft/min / 329 ft/min</span>
	6 x 19 IWRC XIPS, right regular lay, preformed
	<span style="float: right;">5/8 in</span>
	<span style="float: right;">479 ft</span>
	Max. line pull; 1st layer low-range <span style="float: right;">35,800 lbs</span> Max. line pull permissible <span style="float: right;">9,000 lbs</span>





# TECHNICAL DESCRIPTION

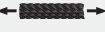

**RT 230-1 XL**

Optional configuration:		
	Hook and ball 2 sheaves 3 sheaves 4 sheaves	7 ton 25 ton 30 ton 30 ton
	Grooved drum Storage capacity	598 ft
	Without load in 6th layer (low range / high range) Without load in 1st layer (low range / high range)	205 ft/min / 329 ft/min 297 ft/min / 475 ft/min
	Rotation resistant compacted strand 18 x 19 or 19 x 19	
		5/8 in
		479 ft
	Minimum breaking strength Max. line pull permissible	35,800 lbs 9,000 lbs

## Superstructure

Standard configuration:		
	Non stop Maximum rotation speed without load	360° 3 rpm
	Hydraulic motor Planetary reducer	
	360° house lock Manually actuated by foot pedal	

## Cab, Controls, Operator aids and Load limiter / Load indicator

Standard configuration:		
	Sliding door Tinted safety glass throughout Six way adjustable seat	
	Armrest mounted dual axis electro-proportional joysticks Steering wheel column with gear selector on the left and directional light selector on the right Dashboard mounted switches for outrigger operation	
	Graphic interface for load indicator	

### Optional configuration:



Heater  
Air conditioner  
Work lights  
Rotating beacon

## Carrier, Engine, Drive-line and Hydraulic system

### Standard configuration:



Hydraulic, independent extension:  
Diameter of outtrigger pads  
Area of outtrigger pads

24 in  
254 in<sup>2</sup>



Cummins QSB4.5 4 cylinders  
Rated power  
Maximum gross torque  
Intake: turbocharger with intercooler  
Fuel type  
Fuel tank capacity

130 hp @ 2,300 rpm  
459 ft-lb @ 1,500 rpm  
Diesel  
50 gallons



6 x 6 powershift transmission with integral torque converter  
Full time 4WD (Four-Wheel Drive)  
Rigid mounted front axle  
Oscillating rear axle  
Differential lock on front axle and rear axle  
Rear axle oscillation lock – manual or automatic actuation  
Air-over-hydraulic disc brakes  
Parking brake on front axle  
Hydraulic oil cooler on carrier



Hydraulic power steering  
Front wheel steering  
Four wheel steering concentric  
Four wheel steering crab  
Optional rear wheel steering package



Hydraulic Pumps:

**Tandem pumps:**

Boom lift / Telescope  
Power steering / Outriggers and Swing

39 gal/min @ 3,500 psi  
21 gal/min @ 2,500 psi

**Single pump:**



Main and auxiliary hoist pump

53 gal/min @ 3,500 psi

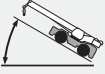

Hydraulic oil reservoir capacity  
Hydraulic oil suction filter  
Hydraulic oil return filter

94 gallons  
250 microns  
5 microns

## Vehicle performance

	Max. in 1 <sup>st</sup> gear Max. in 6 <sup>th</sup> gear	<b>Standard configuration:</b>	112.34 % 3.77 %
	Max. (6 <sup>th</sup> gear)		24.5 mph

## Tires

	Wide tread earth mover pattern (E3)	<b>Standard configuration:</b>	20.5 x 25-24 PR
	Wide tread earth mover pattern (E3)	<b>Optional configuration:</b>	16.00 x 25-28 PR

A large rectangular area consisting of 20 horizontal grey lines, intended for taking notes.



[www.terexcranes.com](http://www.terexcranes.com)

Effective Date: October 2010.

Product specifications and prices are subject to change without notice or obligation. The photographs and/or drawings in this document are for illustrative purposes only. Refer to the appropriate Operator's Manual for instructions on the proper use of this equipment. Failure to follow the appropriate Operator's Manual when using our equipment or to otherwise act irresponsibly may result in serious injury or death. The only warranty applicable to our equipment is the standard written warranty applicable to the particular product and sale and Terex makes no other warranty, express or implied. Products and services listed may be trademarks, service marks or trade-names of Terex Corporation and/or its subsidiaries in the USA and other countries. All rights are reserved. Terex® is a registered trademark of Terex Corporation in the USA and many other countries.

Copyright 2010 Terex Corporation

Terex Cranes, Global Marketing, Dinglerstraße 24, 66482 Zweibrücken, Germany  
Tel. +49 (0) 6332 830, Email: [info.cranes@terex.com](mailto:info.cranes@terex.com), [www.terexcranes.com](http://www.terexcranes.com)

Brochure Reference: TC-DS-I-E-RT230-1 XL -10/10



**WORKS FOR YOU.™**