

Specifications

Lattice Boom Crawler Crane

LS-138H II 80-ton (72.57 metric ton)

HYLAB Series

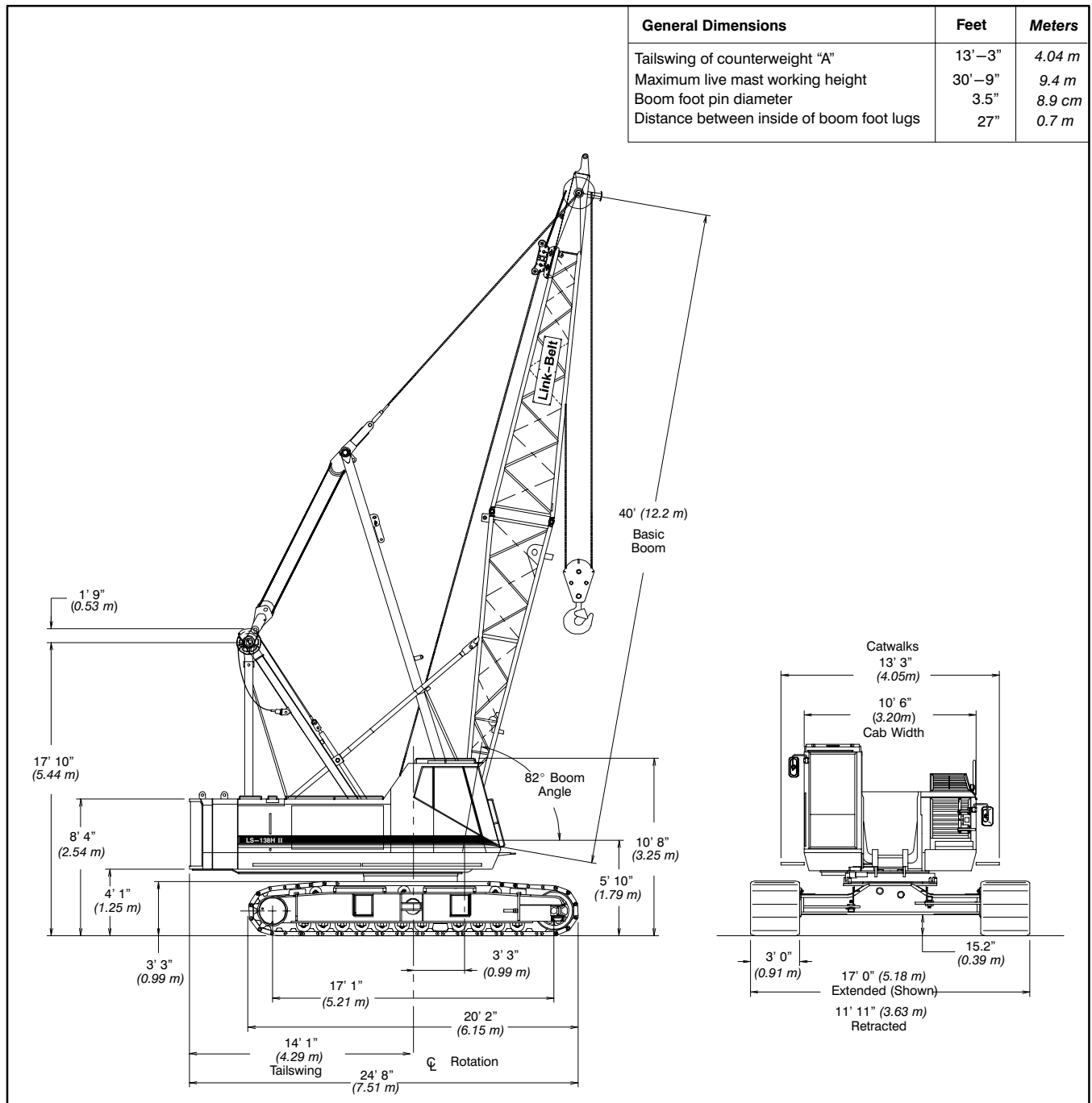

LS-138H II Machine Transport Weights – approximate

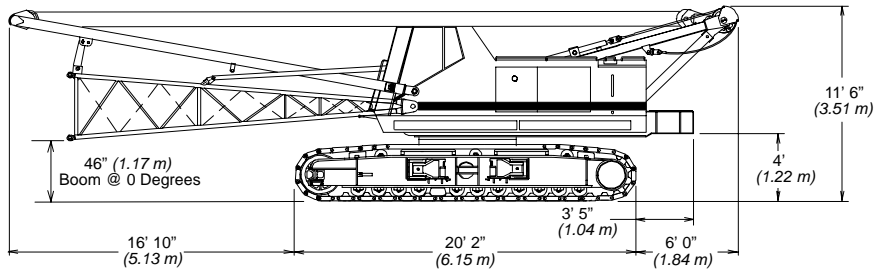
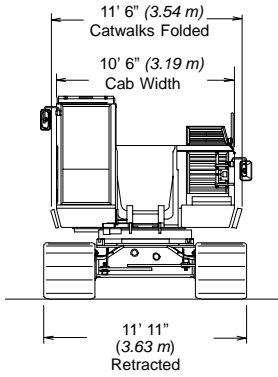

Transport Weight
Rope on both drums, Backstops, Catwalks, and 1/3 tank of fuel
Tube: 89,751 lbs. (40 710 kg)
Angle: 90,651 lbs. (41 119 kg)

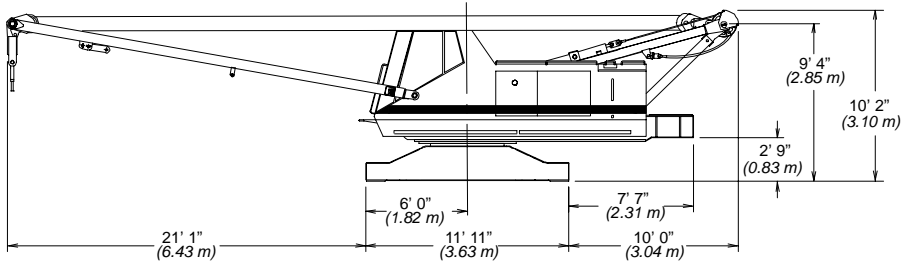
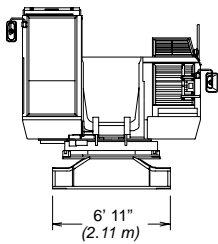

Upper & Carbody Shipping Weight
Rope on both drums, Backstops, Catwalks, and full of fuel
51,300 lbs. (23 269 kg)

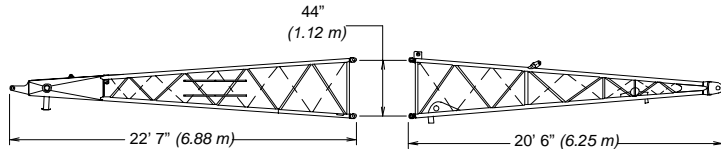
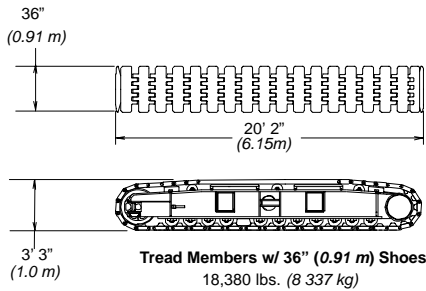

20' (6.10 m) Top Section
Tube: 2,726 lbs. (1 236 kg)
Angle: 3,500 lbs. (1 588 kg)

20' (6.10 m) Base Section
Tube: 1,720 lbs. (780 kg)
Angle: 2,853 lbs. (1 294 kg)

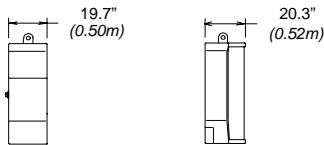

"A" Upper Counterweight 25,250 lbs. (11 453 kg)
"B" Upper Counterweight 25,250 lbs. (11 453 kg)

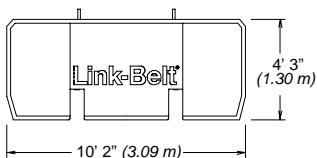
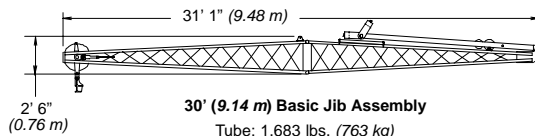

Front Mounted Third Drum w/o Rope
1,345 lbs. (610 kg)

LS-138H II Transportation Weights – approximate

Base Machine: Rigid Boom Backstops, 27 Gallons (102.2 L) of Fuel, Catwalks (front right and left side), 20' (6.10 m) Tube Base Section, 24' (6.10m) Live Mast, Bridle & Spreader Bar, 14-Part Boom Hoist Reeving, 700' (189 m) of Type 'DB' Front Hoist Rope, 540' (165m) of Type 'RB' Rear Hoist Rope.

Item Description	Gross Weight		Transport Loads			Notes and Load Summary
	lbs.	kg	Load #1	Load #2	Load #3	
Base Machine	89,751	40 710	1			Numbers in the load columns to the left represent quantities.
Add "A" Counterweight	25,250	11 453			1	Estimated transport load assumes the load out consist of 200' (60.96 m) of tube boom + 60' (18.29 m) of jib with full counterweight.
Add "B" Counterweight	25,250	11 453		1		
Add Hydraulic Third Drum w/o rope	1,345	610				Support loads were targeted at 45,000 lb (20 412 kg), 8'-6" (2.6 m) wide, 48' (14.63 m) long, and 13'-6" (4.11 m) high using a drop deck trailer. This may vary depending on state laws, empty truck/trailer weights, and style of trailer.
Add 20' (6.1m) Tube Top Section	2,726	1 237		1		
Add 10' (3.05m) Tubular Extension w/pins & pendants	677	307			1	Support loads were targeted at 45,000 lb (20 412 kg), 8'-6" (2.6 m) wide, 48' (14.63 m) long, and 13'-6" (4.11 m) high using a drop deck trailer. This may vary depending on state laws, empty truck/trailer weights, and style of trailer.
Add 20' (6.1m) Tubular Extension w/pins & pendants	1,076	488		1	2	
Add 30' (9.1m) Tubular Extension w/pins & pendants	1,481	672		2	1	Support loads were targeted at 45,000 lb (20 412 kg), 8'-6" (2.6 m) wide, 48' (14.63 m) long, and 13'-6" (4.11 m) high using a drop deck trailer. This may vary depending on state laws, empty truck/trailer weights, and style of trailer.
Add 20' (6.1m) Angle Base Section at 0 degrees	2,853	1 294				
Add 20' (6.1m) Angle Top Section with 4 Lifting Sheaves	3,500	1 588				Support loads were targeted at 45,000 lb (20 412 kg), 8'-6" (2.6 m) wide, 48' (14.63 m) long, and 13'-6" (4.11 m) high using a drop deck trailer. This may vary depending on state laws, empty truck/trailer weights, and style of trailer.
Add 20' (6.1m) Angle Top Section with 3 Lifting Sheaves	3,400	1 592				
Add 20' (6.1m) Angle Top Section with 2 Lifting Sheaves	3,300	1 497				Support loads were targeted at 45,000 lb (20 412 kg), 8'-6" (2.6 m) wide, 48' (14.63 m) long, and 13'-6" (4.11 m) high using a drop deck trailer. This may vary depending on state laws, empty truck/trailer weights, and style of trailer.
Add 10' (3.05m) Angular Extension w/pins & pendants	1,040	472				
Add 20' (6.1m) Angular Extension w/pins & pendants	1,680	762				Support loads were targeted at 45,000 lb (20 412 kg), 8'-6" (2.6 m) wide, 48' (14.63 m) long, and 13'-6" (4.11 m) high using a drop deck trailer. This may vary depending on state laws, empty truck/trailer weights, and style of trailer.
Add 30' (9.1m) Angular Extension w/pins & pendants	2,400	1 089				
Add Bridle & Spreader Bar Only (No Live Mast)	990	449				Support loads were targeted at 45,000 lb (20 412 kg), 8'-6" (2.6 m) wide, 48' (14.63 m) long, and 13'-6" (4.11 m) high using a drop deck trailer. This may vary depending on state laws, empty truck/trailer weights, and style of trailer.
Add Tagline Winder	760	345				
Add Fairleader	500	227				Support loads were targeted at 45,000 lb (20 412 kg), 8'-6" (2.6 m) wide, 48' (14.63 m) long, and 13'-6" (4.11 m) high using a drop deck trailer. This may vary depending on state laws, empty truck/trailer weights, and style of trailer.
Add PAT DS-350	100	45				
Add 30' (9.1m) Tubular Jib	1,683	763			1	Support loads were targeted at 45,000 lb (20 412 kg), 8'-6" (2.6 m) wide, 48' (14.63 m) long, and 13'-6" (4.11 m) high using a drop deck trailer. This may vary depending on state laws, empty truck/trailer weights, and style of trailer.
Add 15' (4.6m) Tubular Jib Extension	317	144			2	
Add 5' (1.5m) Auxiliary Tip Extension	800	363				Support loads were targeted at 45,000 lb (20 412 kg), 8'-6" (2.6 m) wide, 48' (14.63 m) long, and 13'-6" (4.11 m) high using a drop deck trailer. This may vary depending on state laws, empty truck/trailer weights, and style of trailer.
Add Holding Rope – 0.88" X 165' Type 'DB'	234	106				
Add Closing Rope – 0.88" X 220' Type 'DB'	312	142				Support loads were targeted at 45,000 lb (20 412 kg), 8'-6" (2.6 m) wide, 48' (14.63 m) long, and 13'-6" (4.11 m) high using a drop deck trailer. This may vary depending on state laws, empty truck/trailer weights, and style of trailer.
Add Inhaul Rope – 0.88" X 80' Type 'M'	108	49				
Add Hoist Rope – 0.88" x 165' Type 'DB'	234	106				Support loads were targeted at 45,000 lb (20 412 kg), 8'-6" (2.6 m) wide, 48' (14.63 m) long, and 13'-6" (4.11 m) high using a drop deck trailer. This may vary depending on state laws, empty truck/trailer weights, and style of trailer.
Add Jib Wire Rope – 0.88" X 700' Type 'DB'	994	451				
Add 3rd Drum Wire Rope 0.63" X 385' Type 'ZB'	312	142				Support loads were targeted at 45,000 lb (20 412 kg), 8'-6" (2.6 m) wide, 48' (14.63 m) long, and 13'-6" (4.11 m) high using a drop deck trailer. This may vary depending on state laws, empty truck/trailer weights, and style of trailer.
Add 3rd Drum Wire Rope 0.63" X 385' Type 'WB'	296	134				
Add Auxiliary Lifting Bail	200	91				Support loads were targeted at 45,000 lb (20 412 kg), 8'-6" (2.6 m) wide, 48' (14.63 m) long, and 13'-6" (4.11 m) high using a drop deck trailer. This may vary depending on state laws, empty truck/trailer weights, and style of trailer.
Add 15-ton (13.6mt) Hook Ball – Non Swivel	750	340		1		
Add 15-ton (13.6mt) Hook Ball – Swivel	760	345				Support loads were targeted at 45,000 lb (20 412 kg), 8'-6" (2.6 m) wide, 48' (14.63 m) long, and 13'-6" (4.11 m) high using a drop deck trailer. This may vary depending on state laws, empty truck/trailer weights, and style of trailer.
Add 80-ton (72.6mt) 4 Sheave Hook Block	2,325	1 055		1		
Remove 20' Tube Base Section	-1,988	-902				Support loads were targeted at 45,000 lb (20 412 kg), 8'-6" (2.6 m) wide, 48' (14.63 m) long, and 13'-6" (4.11 m) high using a drop deck trailer. This may vary depending on state laws, empty truck/trailer weights, and style of trailer.
Remove Front Hoist Rope 0.88" X 700' Type 'DB'	-944	-451				
Remove Jib Wire Rope 0.88" X 540' Type 'RB'	-810	-367				Support loads were targeted at 45,000 lb (20 412 kg), 8'-6" (2.6 m) wide, 48' (14.63 m) long, and 13'-6" (4.11 m) high using a drop deck trailer. This may vary depending on state laws, empty truck/trailer weights, and style of trailer.
Remove 24' (7.3m) Live Mast with Bridle & Spreader Bar	-2,618	-1 188				
Add 50 gallons (189.3L) of Fuel	362	164				Support loads were targeted at 45,000 lb (20 412 kg), 8'-6" (2.6 m) wide, 48' (14.63 m) long, and 13'-6" (4.11 m) high using a drop deck trailer. This may vary depending on state laws, empty truck/trailer weights, and style of trailer.

Machine Working Weight

Option	Description	Gross Weight lbs. (kg)	Ground Bearing Pressure psi (kg/cm ²)
1	Base Machine equipped with 40' (12.2 m) of tubular boom, live mast, "A" counterweight, 700' (213 m) front hoist rope, 540' (164.6 m) rear hoist rope, 80-ton (72.6 mt) hook block, 77 gallons (291.4 L) of fuel, and a 200 lbs. (90.7kg) operator.	121,097 (54 929)	7.71 (0.54)
2	Option #1 plus "B" counterweight, midpoint pendants, and 160' (48.77m) of boom extensions to obtain 200' (60.96 m) of main boom.	155,627 (70 591)	9.92 (0.70)
3	Option #2 plus 60' (18.29 m) of jib and 15-ton (13.61 mt) hookball – subtract 20' (6.10 m) of boom extension and midpoint pendants to obtain maximum 180' + 60' (54.86 + 18.29 m) of main boom + jib.	157,452 (71 419)	10.03 (0.70)
4	Base Machine equipped with 40' (12.20 m) of angle boom, live mast, "A" counterweight, 700' (213 m) front hoist rope, 540' (164.59 m) rear hoist rope, 80-ton (72.57 mt) hook block, 77 gallons (291.4 L) of fuel, and a 200 lbs. (90.7kg) operator.	121,722 (55 212)	7.76 (0.54)
5	Option #4 plus "B" counterweight and 110' (33.55 m) of boom extensions to obtain 150' (45.72 m) of main boom.	156,172 (70 838)	9.95 (0.71)
6	Option #5 plus 60' (18.29 m) of jib and 15-ton (13.61 mt) hookball to obtain maximum 150' + 60' (45.72 + 18.29 m) of main boom + jib.	155,387 (70 482)	9.90 (0.70)

Notes:

- Ground bearing pressure is based on the total weight distributed evenly over the track contact area.
- Total contact area for 36" (0.91m) track shoes is 15,689 in² (101,219cm²).

Attachment Options

■ 40'–200' Tube Boom (12.19 – 60.96 m)

Basic Tube Boom – 40' (12.19 m) two-piece design that utilizes a 20' (6.10 m) base section and a 20' (6.10 m) open throat top section with in-line connecting pins on 54" (1.37 m) wide and 44" (1.12 m) deep centers.

- Boom feet on 50" (1.27 m) centers
- 3" (76.2 mm) diameter chords
- Lugs on base section to attach carrying links
- Skywalk platform
- Deflector roller on top section
- Permanent skid pads mounted on top section to protect head machinery
- Rigid sheave guards
- Five 18" (0.46 m) root diameter steel sheaves mounted on sealed anti-friction bearings
- Mechanical boom angle indicator

Optional – Handling system that mounts in the boom base to allow loading/unloading of a counterweight or a boom section onto transport trailers.

Tube Boom Extensions – The following table provides the lengths available and the suggested quantity to obtain maximum boom in 10' (3.05 m) increments. Midpoint pendant connections are required at 80' (24.38 m) for 190' (57.91 m) and 200' (60.96 m) boom lengths.

Tube Boom Extensions	Suggested Quantity for Max. Boom
10' (3.05 m)	1
20' (6.10 m)	1
30' (9.14 m)	4

- Deflector roller on top of each section
- Appropriate length pendants
- Maximum tube boom tip height of 204' (62.18 m)

■ 40'–150' Angle Boom (12.19 – 45.72 m)

Basic Angle Boom – 40' (12.19 m) two-piece design that utilizes a 20' (6.10 m) base section and a 20' (6.10 m) open throat top section with in-line connecting pins. Boom extensions are 48" (1.22 m) wide and 48" (1.22 m) deep at outside dimensions of angles.

- Boom feet on 50" (1.27 m) centers
- 4" X 4" X 0.38" (101.6 x 101.6 x 9.5 mm) angle chords
- Lugs on base section to attach carrying links
- Skywalk platform
- Deflector roller on top section
- Permanent skid pads mounted on top section to protect head machinery
- Rigid sheave guards
- Four 18" (0.46 m) root diameter steel sheaves mounted on sealed anti-friction bearings
- Mechanical boom angle indicator

Optional – Three sheave head machinery for clam applications or two wide sheaves for dragline applications

Angle Boom Extensions – The following table provides the lengths available and the suggested quantity to obtain maximum boom in 10' (3.05 m) increments. Midpoint pendant connections are not required.

Angle Boom Extensions	Suggested Quantity for Max. Boom
10' (3.05 m)	1
20' (6.10 m)	2
30' (9.14 m)	2

- Deflector roller on top of each section
- Appropriate length pendants
- Maximum angle boom tip height of 154' (46.94 m)

■ 30' – 60' Tube Jib (9.14– 18.29 m)

Basic Tube Jib – 30' (9.14 m) two-piece design that utilizes a 15' (4.57 m) base section and a 15' (4.57 m) top section with in-line connecting pins on 32" (0.81 m) wide and 24" (0.61 m) deep centers.

- 2" (50.8 mm) diameter tubular chords
- One 18.5" (0.47 m) root diameter steel sheave mounted on sealed anti-friction bearings.
- 15' (0.38 mm) jib extensions provide jib lengths at 45' (13.76 m) and 60' (18.29 m)
- Jib offset angles at 5, 15 and 25 degrees
- Maximum tip height of boom + jib is 242' (73.76 m) using the tube boom and 204' (62.53 m) using the angle boom

■ Auxiliary 5' (1.52 m) Tip Extension

Designed to use instead of a jib to provide clearance between working hoist lines. The extension is equipped with a single 15.25" (0.39 m) root diameter steel sheave mounted on sealed anti-friction bearings. Maximum capacity is 9-ton (8.16 mt).

■ Boom Hoist System

Designed to lift off maximum boom or maximum boom plus jib unassisted. Operates up to a maximum boom angle of 82 degrees. Automatically limits maximum boom angle operation.

- Retractable gantry frame
- Pin-on bail frame
- 14-part reeving with 5/8" (14.7 mm) type 'W' wire rope
- Bridle assembly
- 24' (7.31 m) live mast (optional for angle attachment)
- Two 1.25" (31.75 mm) pendants
- Telescopic boom backstops (tubular-type)
- Sheaves contain sealed anti-friction bearings
- Boom speed from 10°–70° is 52 seconds with no load and 94 seconds with full load. Speed was determined using 100' (30.5 m) of tube boom

Revolving Upperstructure

■ Frame

All welded steel frame with precision machined surfaces for mating parts.

■ Engine

Isuzu A-6SDITQB with oil cooler, oil cooler, air cleaner, fuel filter, water separator, hour meter, tachometer, and electrical shutdown.	
Number of cylinders	6
Bore and stroke – in (mm)	4.72 x 5.71 (120 x 145)
Piston displacement – in ³ (cm ³)	600 (9 839)
Engine rpm at full load speed	2,100
Hi-idle rpm	2,325
Full load speed – horsepower (kw)	207 (155)
Peak torque – ft lb (joule)	513 (696)
Peak torque – rpm	1,400
Electrical system	24 volt
Batteries	2-12 volt
Approximate fuel consumption	Gal./hr (L/hr)
100% H.P.	11.50 (43.53)
75% H.P.	8.60 (32.55)
50% H.P.	5.75 (21.77)
25% H.P.	2.87 (10.86)

■ Hydraulic System

Hydraulic Pumps – The pump arrangement is designed to provide hydraulically powered functions allowing positive, precise control with independent or simultaneous operation of all crane functions.

- Two variable displacement pumps operating at 4,000 psi (281.24 kg/cm²) and 64 gal/min (243 l/min) powers load hoist drums, boom hoist drum, optional third drum, and travel.
- One fixed displacement gear type pump operating at 3,600 psi (250 kg/cm²) and 32 gal/min (121 l/min) powers the swing, and treadmember retract cylinders.
- One fixed displacement gear type pump operating at 1,250 psi (85 kg/cm²) and 8 gal/min (32 l/min) powers the pilot control system, clutches, brakes, pump controls, counterweight removal system, and optional handling system mounted in boom base.

Pump Control (“Fine Inching”) mode

Special pump setting, selectable from operator’s cab, that allows very slow movements of load hoist drums, boom hoist drum, and travel for precision work.

Hydraulic Reservoir – 78 US gallons (295 l), equipped with sight level gauge. Diffusers built in for deaeration.

Filtration – One 10 micron, full flow, line filter in the control circuit. All oil is filtered prior to entering the reservoir.

Counterbalance Valves – All hoist motors are equipped with counterbalance valves to provide positive load lowering and prevent accidental load drop if the hydraulic pressure is suddenly lost.

■ Load Hoist Drums

Each drum contains a pilot controlled, bi-directional, axial piston motor and a planetary gear reduction unit to provide positive control under all load conditions.

- Power up/down & free-fall operation modes
- Automatic brake mode (spring applied, hydraulically released, band type brake)
- 0.88” (22.22 mm) grooved lagging
- Drum pawl controlled manually
- Electronic drum rotation indicators
- Mounted on anti-friction bearings
- 17.64” (0.45 m) root diameter
- 29.92” (0.76 m) flange diameter
- 19.84” (0.50 m) width

Note: The freefall operational mode is designed to prevent load lowering even if the freefall switch is accidentally activated. The automatic brake mode meets all OSHA requirements for personnel handling.

Drum Clutches – Speed-o-Matic™ power hydraulic two shoe clutch design that uses a 20” (0.51 m) diameter x 5” (127 mm) wide shoe that internally expands to provide load control. Swept area is 314 in² (2 026 cm²).

■ Optional Front Mounted Third Hoist Drum

The hydraulic winch is pinned to the front of the upper frame and is used in conjunction with a fleeting sheave and 3-sheave idler assembly to run the wire rope over the boom top section.

- Free-spooling capability for pile driving applications
- 10.63” (0.27 m) root diameter
- 20” (0.51 m) outside flange diameter
- 13.5” (0.34 m) width
- Mounted on anti-friction bearings

■ Boom Hoist Drum

Contains a pilot controlled, bi-directional, axial piston motor and a planetary gear reduction unit to provide positive control under all load conditions.

- Spring applied, hydraulically released, disc type brake controlled automatically
- 5/8” (15.88 mm) grooved lagging
- Drum pawl controlled manually
- Mounted on anti-friction bearings
- 12.60” (0.31 m) root diameter
- 24.41” (0.62 m) flange diameter
- 9.57” (0.24 m) width

■ Swing System

Mechanical linkage controls the bi-directional axial piston motor and the planetary gear reduction unit to provide positive control under all load conditions.

- Spring applied, hydraulically released, 360 degree multi-plate brake
- Free swing mode when lever is in neutral position
- Two position positive house lock
- Audio/Visual swing alarm
- Maximum swing speed is 2.8 rpm

■ Upper Counterweight

Consist of a two piece design that can be easily lowered to the ground using the gantry.

- 25,250 lbs. (11 453 kg) “A” upper counterweight
- 25,250 lbs. (11 453 kg) “B” upper counterweight can be added to maximize capacities

■ Operator’s Cab and Controls

Fully enclosed modular steel compartment is independently mounted and insulated to protect against vibration and noise.

- All tinted/tempered safety glass
- Sliding entry door and front window
- Swing up roof window with wiper
- Door and window locks
- Heater with circulating fan
- Air conditioner
- Sun visor
- Engine instrumentation panel (tachometer, voltmeter, engine oil pressure, engine water temperature, fuel level, hydraulic oil temperature, and service monitor system)
- Mechanical drum rotation indicators
- Six way adjustable seat
- Dry chemical fire extinguisher
- Hand and foot throttle
- Single axis, armchair control levers
- Swing lever with swing brake and horn located on handle
- Bubble type level

(continued on page 7)

LS-138H II Load Hoisting Performance

Available line speed and line pull – based on Isuzu A-6SDITQB at 2,000 rpm full load speed. Line pulls are not based on wire rope strength. See wire rope capacity chart for maximum permissible single part of line working loads.

Rope Layer	Front or Rear Drum – 7/8" (22.22 mm) Wire Rope											
	Maximum Line Pull		No Load Line Speed		Full Load Line Speed		Pitch Diameter		Layer		Total	
	lbs.	kg	ft/min.	m/min	ft/min.	m/min	in.	mm	ft.	m	ft.	m
1	32,430	14 710	298	91	113	35	18.5	470	100	30	100	30
2	29,630	13 440	326	99	124	38	20.3	516	109	33	209	64
3	27,274	12 372	354	108	135	41	22.0	559	119	36	327	100
4	25,266	11 461	382	116	145	44	23.8	605	128	39	455	139
5	23,533	10 674	410	125	156	48	25.5	648	137	42	593	181
6	22,023	9 989	438	134	167	51	27.3	693	147	45	740	225
7	–	–	–	–	–	–	29.0	737	156	48	896	273

Rope Layer	Boom Hoist Drum – 5/8" (15.88 mm) Wire Rope											
	Maximum Line Pull		No Load Line Speed		Full Load Line Speed		Pitch Diameter		Layer		Total	
	lbs.	kg	ft/min.	m/min	ft/min.	m/min	in.	mm	ft.	m	ft.	m
1	17 832	8 089	196	60	109	33	13.2	336	48	15	48	15
2	16 282	7 385	214	65	119	36	14.5	368	52	16	100	31
3	14 979	6 794	233	71	130	40	15.7	400	57	17	157	48
4	13 869	6 291	251	77	140	43	17.0	432	61	19	218	67
5	12 913	5 857	270	82	151	46	18.3	464	66	20	284	87
6	11 080	5 479	289	88	161	49	19.5	496	70	21	355	108
7	11 348	5 147	307	94	171	52	20.8	528	75	23	430	131
8	10 699	4 853	326	99	182	55	22.0	560	80	24	509	155

Rope Layer	Optional Third Drum – 5/8" (15.88 mm) Wire Rope											
	Maximum Line Pull		No Load Line Speed		Full Load Line Speed		Pitch Diameter		Layer		Total	
	lbs.	kg	ft/min.	m/min	ft/min.	m/min	in.	mm	ft.	m	ft.	m
1	15,041	6 822	157	48	143	44	11.25	286	57	17	57	17
2	13,537	6 140	175	53	159	48	12.50	318	64	20	121	37
3	12,307	5 582	192	59	175	53	13.75	349	71	22	192	59
4	11,282	5 117	210	64	191	58	15.00	381	77	23	269	82
5	10,414	4 724	228	69	207	63	16.25	413	83	25	352	107
6	9,671	4 387	245	75	223	68	17.50	445	90	27	442	135

Wire Rope Application	Diameter		Length		Type	Maximum Permissible Load	
	in	mm	ft	m		lb	kg
Boom Hoist	5/8	15.88	610	186	W	11,770	5 339
Front Hoist	7/8	22.22	700	213	DB	22,740	10 315
Rear Hoist (Optional)	7/8	22.22	540	165	RB	17,520	7 947
Rear Hoist (Optional)	7/8	22.22	700	213	DB	22,740	10 315
Third Drum (Optional)	5/8	15.88	385	117	ZB	11,080	5 026
Third Drum (Optional)	5/8	15.88	385	117	WB	13,650	6 192

Rope Type	Description
DB	6 x 26 (6 X 19 Class) – Warrington Seale – Extra Improved Plow Steel – Preformed – Right Lay – Regular Lay – I.W.R.C.
RB*	18 x 19 (19 x 19 Class) – Rotation Resistant – Extra Improved Plow Steel – Preformed – Right Lay – Regular Lay – Swaged – SF=5.1
ZB	36 x 7 – Non-rotating – Extra Improved Plow Steel – Right Lay – Regular Lay – S.F.=5.1
WB	8 Strand – Regular Lay
W	6 x 26 (6 x 19 Class) – Warrington Seale – Extra Improved Plow Steel – Preformed – Right Lay – Alternate Lay

* – Use of swivel ball is not recommended.

Revolving Upperstructure (continued from page 5)

■ Load Indicator/ Rated Capacity Limiter

Standard Equipment – PAT EI-65 load indicator provides two lineriders, angle sensor, computer, display, and anti-two block equipment to provide the following information.

- Boom length & angle.
- Jib length & angle.
- Load on hook.
- Load radius.
- Tip height.
- Anti-two block warning & function limiters.
- Operation mode.
- Operator settable alarms provide audio/visual warning.

Optional Equipment – PAT DS-350 rated capacity limiter provides all the same equipment and features of the standard EI-65 in conjunction with the following features.

- Provides an audio/visual warning when the load on hook is within 90% of the cranes rated load.
- Provides an audio/visual warning and limits functions when the load on hook is at 100% of the cranes rated load.

Note: The DS-350 function limiters are activated for anti-two block and overload conditions. These limiters are designed to prevent hoist up on front and rear drums and boom down.

■ Additional Equipment – *Standard*

- 57.88" (1.47 m) outside diameter turntable bearing.
- Front, right, & left side removable catwalks.
- 77 US Gallons (291.5 L) fuel tank (usable quantity).
- Machine lifting links.

■ Additional Equipment – *Optional*

- Rud-o-matic® model 1248 tagline winder for angle boom (double barrel, spring wound, drum type).
- Rud-o-matic® model 648 tagline winder for tube boom.
- Full revolving type Fairleader with barrel, sheaves, and guide rollers.

Lower Structure

■ Lower Frame

All welded box construction frame with precision-machined surfaces for turntable bearing and rotating joint.

- 8'-10.7" (2.71 m) overall width.
- 11'-11" (3.63 m) overall length.

■ Treadmembers

All welded, precision-machined, steel frames can be hydraulically extended and retracted by a hydraulic cylinder mounted in the lower frame.

- 14' (4.27 m) extended gauge.
- 8'-11" (2.72 m) retracted gauge.
- 20'-2" (6.15 m) overall length.
- 36" (0.91 m) wide track shoes.
- 11 sealed (oil filled) track rollers per treadmember.
- Sealed (oil filled) idler and drive planetaries.
- Compact travel drives.
- Hydraulic self adjusting tracks.

Travel and Steering – Each treadmember contains a pilot controlled, bi-directional, axial piston motor and a planetary gear reduction unit to provide positive control under all load conditions.

- Individual control provides smooth, precise maneuverability including full-counter-rotation.
- Spring applied, hydraulically released disc type brake controlled automatically.
- Maximum travel speed is 1.0 mph (1.7 km/h) in high speed and 0.6 mph (1 km/h) in low speed.
- Designed to 30% gradeability.

