



RT110

RT110 PRODUCT GUIDE

Complies with ANSI B30.5

Rough Terrain Crane

110 ton lift capacity (100 metric ton)

141' main boom (43 m)

35' - 60' jib (11 - 19 m)



RT110

CONTENTS

2 FEATURES

3 KEY / SYMBOLS

4-6 TECHNICAL DESCRIPTION

7 CRANE AND COMPONENT WEIGHTS

8 CRANE DIMENSIONS

9 WORKING RANGE DIAGRAM

10-15 LOAD CHARTS



HEADQUARTERS

Global Machinery & Equipment, LLC.
14800 Jersey Shore Drive, Houston, TX 77047 USA
Phone: +1 (713) 586-8808 | Fax: +1 (713) 586-8805
Info@globalcranesales.com | www.globalcranesales.com

FEATURES



Formed boom made with high-yield steel which reduces the operating weight of the boom and maximizes performance.



We chose the AxleTech brand axle because AxleTech offers the most reliable product on the market and has years of experience in manufacturing mobile crane axles.



Full vision operator cab is designed for maximum comfort and ease of operation.



The Dana 16.4HR 36626 transmission offers the latest technology for the diverse needs of off-road cranes.

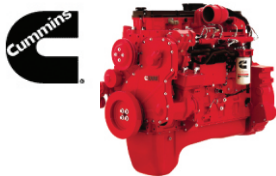

The Cummins QSC 8.3 diesel engine is TIER-III compliant and is proven to have superior performance and durability.

Greer RCI 777 LMI (load moment indicator) delivers the industry's most reliable electronic monitoring system available.



























STANDARD EQUIPMENT

- Formed boom
- Offsettable jib 0° - 20° - 40°
- Auxiliary winch
- Cameras
- Auxiliary lifting sheave
- 110 ton hook block
- 7.7 ton hook ball
- Rotation resistant wire rope
- Deluxe tilt seat
- Air conditioner / Heater
- Work light package: boom, cab and super structure
- Revolving amber light
- AM/FM radio
- Battery disconnect switch
- Front and rear lift lugs

ANSI & CE certified

KEY / SYMBOLS

	Engine	p4		Load Moment Indicator (LMI)	p5
	Transmission	p4		Max. boom length with jib ext.	p5
	Axles	p4		Main boom	p6
	Steering	p4		Main and auxiliary winches	p6
	Gradeability	p4		Cameras	p6
	Brakes	p4		Hook block	p6
	Tires and wheels	p4		Hook ball	p6
	Outrigger system (100%, 50%, 0% extended)	p4		Crane with counterweight	p7
	Hydraulic system	p5		Side stowed jib	p7
	Operator cab	p5		Distance from the hook to the head	p8
	Counterweight	p5		Tip height	p9
	Swing	p5		Working radius	p9

TECHNICAL DESCRIPTION



ENGINE

Cummins QSC 8.3 Inline 6 cylinder intercooled turbo diesel.
 Horsepower Hp (kW) 305 (224) @ 2200 rpm.
 Peak torque ft. lb. (Nm) 1000 (1356) @ 1500 rpm.
 80 gallon (303 L) fuel tank capacity.

USA Federal EPA / California ARB / European EU / Tier III emission rating.



TRANSMISSION

Dana powershift (16.4HR 36626) transmission - 6 speeds forward and 3 speeds reverse.
 Front axle disconnect offering both 4x4 and 4x2 operation.
 Max. speed 14.9 mph (24 km/hr).



AXLES

Axletech front and rear steering axles with planetary reduction.
Front - Rigid mount.
Rear - Full floating rear axle. Automatic rear axle oscillating lock occurs when superstructure is swung 10° from centerline in either direction.



STEERING

Power steering with four independent modes.
 Front-Wheel
 Rear-Wheel
 All-Wheel
 Crab

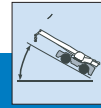

GRADEABILITY

109.8% max. gradeability in 1st gear 4x4.
 3.7% max. gradeability in 6th gear 4x2.



BRAKES

18.5 inches (470 mm) diameter disc brakes on all wheels hydraulically operated.



TIRES AND WHEELS

29.5R29 radial, earthmoving style tires. Steel disc wheels.

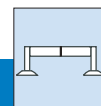

OUTRIGGER SYSTEM

Four independent horizontal beams and vertical jacks with integral holding valves, each independently controlled from operator cab.
 100% - Fully extended outriggers
 footprint 25.9 sq. ft. (7.9 sq. m).
 50% - Mid position outriggers
 footprint 18.2 sq. ft. (5.54 sq. m).
 0% - Fully retracted outriggers
 footprint 10.4 sq. ft. (3.18 sq. m).
 Light-weight aluminum, quick-release outrigger pontoons.
 Floating ground bearing area (0.27 sq. m) (418.5 sq. in).
 Outrigger span Length 26.3 ft. (8 m).
 Width 25.9 ft. (7.9 m).

TECHNICAL DESCRIPTION



HYDRAULIC SYSTEM

PERMCO hydraulic pumps.
 Gear pump for main and auxiliary winches, boom hoist and telescope cylinders.
 Gear pump for steering.
 Gear pump for outriggers and slewing.
 396.3 gallon (1500 L) hydraulic reservoir with external sight and temperature gauge.

Easily accessible (10 micron) cartridge style full flow filters with bypass protection.
 Max. operating pressure: 30MPa (4351 psi, 300 bar).



OPERATOR CAB

Full vision operator cab designed for max. comfort. All steel fabrication with acoustical lining and tinted safety glass throughout. The cab has a sliding door on the left and a sliding window on the right with a swing-up skylight with retractable shade and wiper motor. Fully adjustable deluxe seat with tilt. Foot controls for boom telescope, service brake and engine throttle. Tilt steering.

Temperature control is provided by a hydraulically driven air conditioning unit. Easy view dashboard with gauges for all engine sensors and rocker switch outrigger controls. Standard amenities also include bubble level, dome light, left side rearview mirror, seat belt, travel swing lock and signal horn.



COUNTERWEIGHT

Single 22,000 lbs. (10,800 kg) hyd removable counterweight.
 Length 10.5 ft. (3.2 m).
 Width 4.3 ft. (1.3 m).
 Height 2.9 ft. (0.9 m).



SWING

Bi-directional hydraulic swing drive with multi-disc wet brake and planetary reduction gearbox. Spring applied hydraulically released swing brake and 360° pneumatic positive swing lock.
 Max. swing speed: 1.5 rpm.



LOAD MOMENT INDICATOR (LMI)

GREER RCI 777 LMI control system. Microguard graphic display load moment and anti-two block system with audio-visual warning and function limiter.

System displays the following information: crane configuration, boom length, boom angle, load radius, allowed capacity, actual load, and load percentage of allowed capacity.

System includes settable work parameters: min./max. boom length, min./max. boom angle, defined swing area.

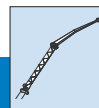

MAX. BOOM LENGTH WITH JIB EXTENSION

35.4-60.7 ft. (10.8-18.5 m) jib consisting of 35.4 ft. (10.8 m) lattice side stow jib and 25 ft. (8 m) manual pull out section. Main jib is offsettable at 0°, 20° and 40°.
 Max. tip height with 35.4 ft. (10.8 m) jib erected is 184 ft. (56.1 m).
 Max. tip height with 35.4 ft. (10.8 m) jib + 25 ft. (7.7 m) fixed pullout extension is 207 ft. (63 m).

TECHNICAL DESCRIPTION



MAIN BOOM

Four section, full power, synchronized boom. Boom is constructed of high-yield steel. 5 sheave quick reeve boom tip with removable rope guards. Rope termination lugs on both sides of boom head. Auxiliary lifting sheave and manual angle indicator are included.

Fully extended boom length: 141 ft. (43 m).
Fully retracted boom length: 37.7 ft. (11.5 m).
Max. tip height, main boom: 149.6 ft. (45.6 m).

Boom angle range (min./max.) -3° / + 78°.
Boom raising / lowering time 82 sec. / 69 sec.
Boom extension / retraction time 170 sec. / 158 sec.

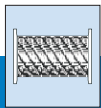

MAIN AND AUXILIARY WINCHES

Standard two speed main and auxiliary hoists, each with planetary reduction and spring applied multi-disk wet brake.

Each hoist features:

Grooved drum lagging.

Hoist drum cable followers.

Max. permissible line pull: 21,605 lbs. (9800 kg).

Winch speed: 0 - 413 fpm. (126 m/min).

Power up / power down.

Electronic drum rotation indicators.

Rope construction: 0.79 in. (20 mm) rotation resistant compacted strand.



CAMERAS

The crane comes equipped with two cameras, a winch camera for viewing hoist operation and a rear camera for viewing the rear of the crane. The monitor is located in the cab, and one can easily toggle between both camera views.

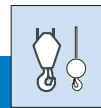

HOOK BLOCK AND HOOK BALL

110 ton, 5 sheave (steel), standard reeve hook block with odd part pin-off and safety latch.





Hook block weight 1951 lbs. (885 kg).

7.7 ton top swivel hook ball with safety latch.

Hook ball weight 360.5 lbs. (164 kg).

CRANE AND COMPONENT WEIGHTS

CRANE OPERATING WEIGHTS						
 Crane with cwt.	Gross Vehicle Weight		Front Axle Load		Rear Axle Load	
	lb	kg	lb	kg	lb	kg
	143,300	65,000	73,193	33,200	70,107	31,800

DEDUCTIONS FOR LOAD HANDLING					
 Jib stowed aside boom  Auxiliary head	lb	kg	 5 sheave 110 ton hook block  7.7 ton hook ball	lb	kg
		2,738		1,242	
	158	72		360.5	164

TURNING RADIUS

Front Wheel (4x2) Steering	Imperial	Metric
Wall to wall over boom attached	46 ft. 2 in	14.1 m
All Wheel (4x4) Steering	Imperial	Metric
Curb to curb	26 ft. 9 in	8.2 m
Tail Swing	Imperial	Metric
With counterweight	14 ft. 2 in	4.6 m

CRANE DIMENSIONS

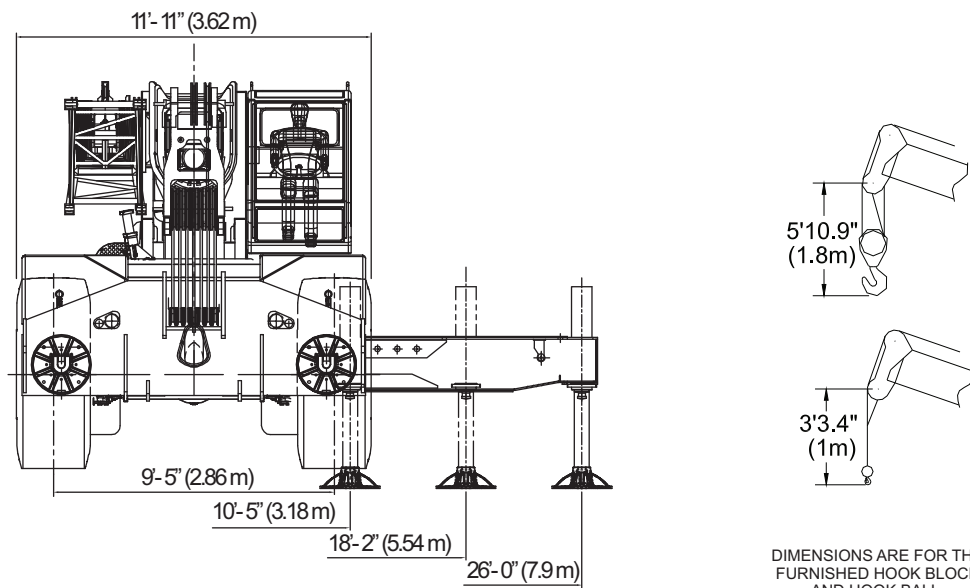
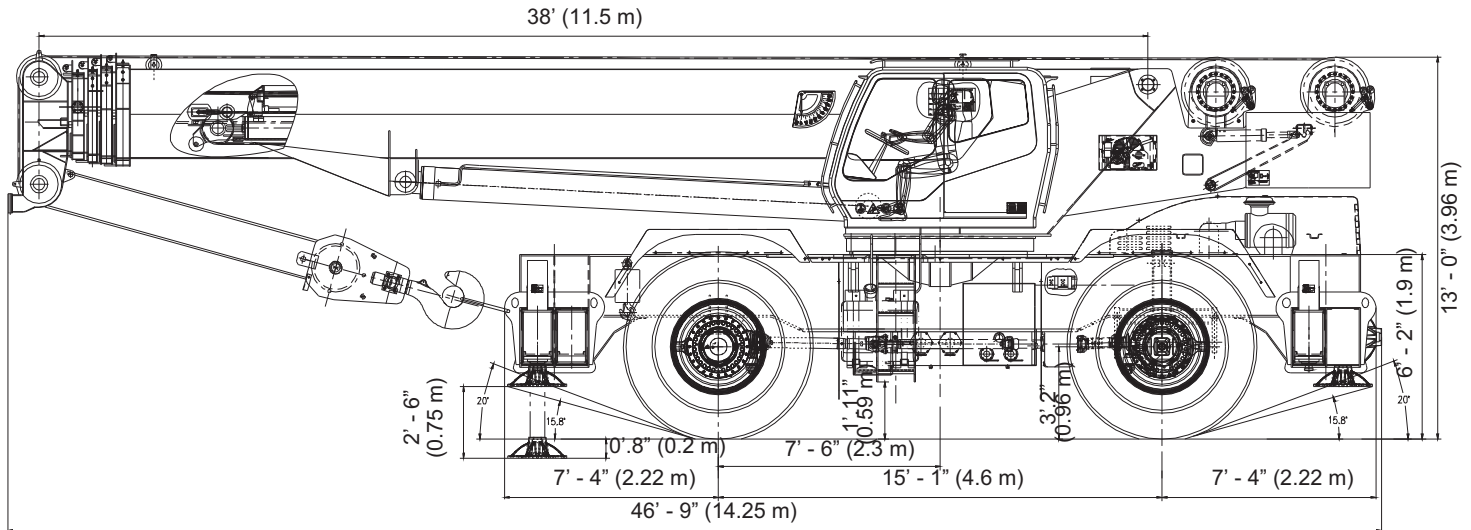

WORKING RANGE DIAGRAM

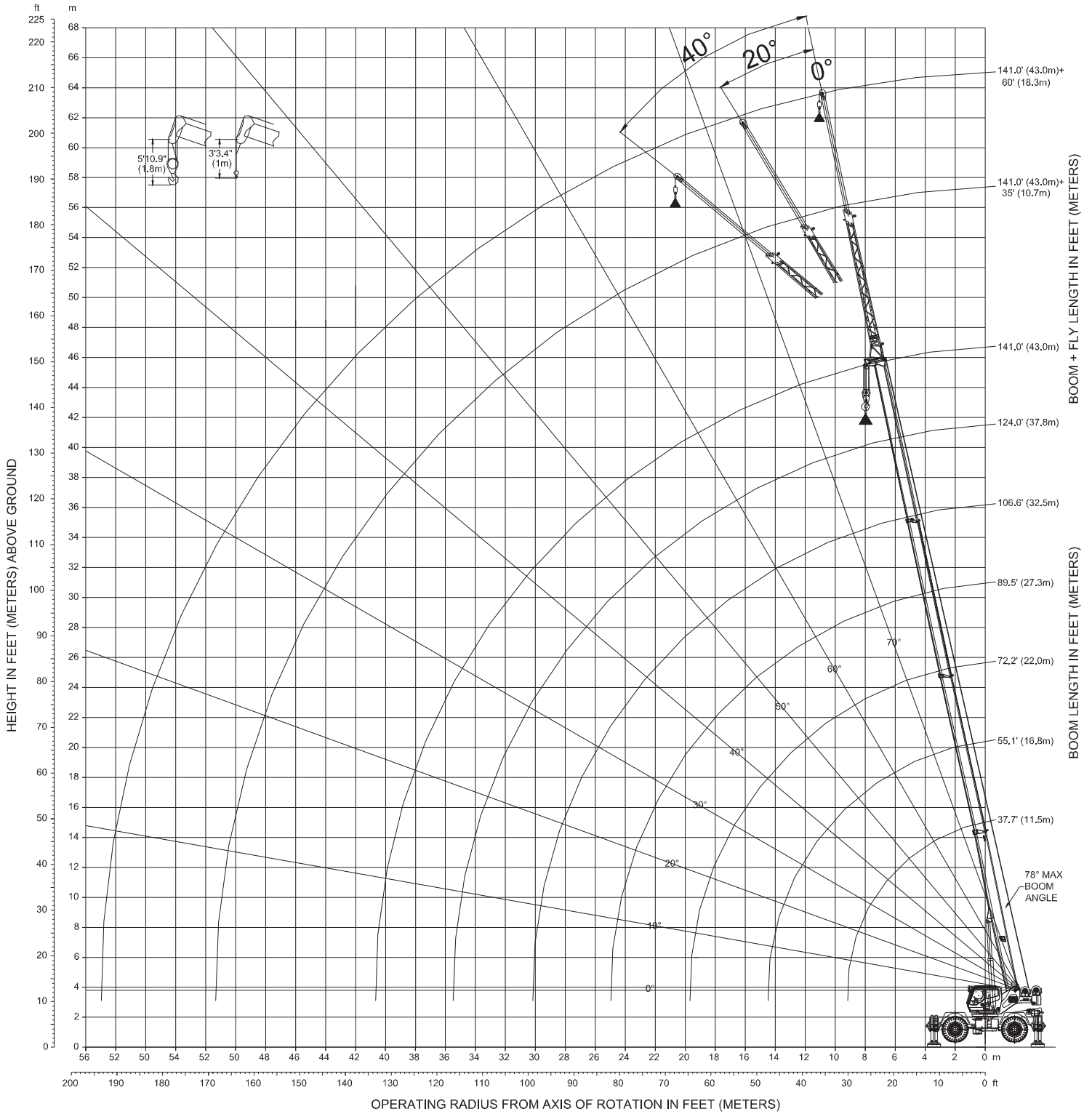

 FULLY EXTENDED OUTRIGGERS - MAIN BOOM CAPACITY 22,000 lbs. ctwt. 22.6 ft. x 22.6 ft. ANSI B30.5 85%										
BOOM LENGTH IN FEET - CAPACITY LISTED IN POUNDS										
RADIUS	38	51	63	76	89	102	115	128	141	RADIUS
FT.										FT.
10	220462	95570								10
11	213297	95570								11
13	186401	95570	96320							13
15	163693	95570	92572							15
16	145615	95570	88273	67219						16
18	130844	95570	84415	64353						18
20	118498	95570	80888	61818	51015					20
21	107960	95570	77581	59503	49141					21
23	99009	95570	74604	57298	47377	40653				23
25	91227	93344	71738	55204	45834	39330				25
26	84481	86620	69203	53330	44291	38118	32055			26
30	73171	75354	64573	49913	41535	35913	30291	28969		30
33		65323	60605	46936	39220	33929	28748	27646	21473	33
36		54432	55049	44291	37016	32165	27425	26433	20481	36
39		46209	47025	41866	35142	30512	26103	25331	19599	39
46			35737	35494	31835	27756	23898	23347	17946	46
52			28263	28307	27955	25331	22024	21583	16623	52
59				23149	23038	22355	20260	19731	15410	59
66				19357	19312	18872	18188	16623	14308	66
72					16424	16094	15609	14132	13162	72
79						13867	13492	12081	11111	79
85						12059	11751	10362	9392	85
92						10648	10296	8929	7959	92
98							9083	7716	6724	98
105							8157	6680	5666	105
112								5820	4740	112
118								5137	3968	118
125									3307	125
131									2800	131

LIFTING CAPACITY NOTES:

Rated lifting capacities shown do not exceed 85% of the tipping loads. The weight of the hook block, hook ball and any additional auxiliary lifting devices are not calculated into the rated lifting capacity and must be deducted prior to operation.

 MID POSITION OUTRIGGERS - MAIN BOOM CAPACITY 22,000 lbs. cwt. 15.8 ft. x 22.6 ft. ANSI B30.5 85%								
BOOM LENGTH IN FEET - CAPACITY LISTED IN POUNDS								
RADIUS	38	51	64	77	90	103	128	RADIUS
FT.								FT.
10	220000	168290	125730					10
12	190124	157378	118446					12
15	145310	141010	107520	89420	76660			15
20	101570	101270	91650	78200	67860	58070		20
25	64380	65650	61700	59810	56850	52010	37170	25
30	45010	46810	45070	44260	42800	40020	34310	30
35		35190	34510	34230	33540	31840	28380	35
40		27360	27220	27220	26950	25910	23590	40
45			21910	22060	22040	21410	19830	45
50			17920	18120	18250	17890	16810	50
55			14910	15030	15240	15050	14340	55
60				12580	12800	12730	12290	60
65				10630	10790	10800	10500	65
70					9130	9170	9070	70
75					7750	7790	7790	75
80					6670	6610	6670	80
85						5610	5680	85
90						4780	4820	90
95						10210	4060	95
100							3380	100
105							2790	105
110							2290	110
115							1920	115

LIFTING CAPACITY NOTES:

Rated lifting capacities shown do not exceed 85% of the tipping loads. The weight of the hook block, hook ball and any additional auxiliary lifting devices are not calculated into the rated lifting capacity and must be deducted prior to operation.

 FULLY RETRACTED OUTRIGGERS - MAIN BOOM CAPACITY 22,000 lbs. cwt. 9 ft. x 22.6 ft. ANSI B30.5 85%								
BOOM LENGTH IN FEET - CAPACITY LISTED IN POUNDS								
RADIUS	38	51	64	77	90	103	124	RADIUS
FT.								FT.
10	183700	168290	125730					10
12	122940	119290	101670					12
15	79430	78960	70600	66650	61250			15
20	46530	47690	44570	43180	40910	37170		20
25	30540	32090	30870	30420	29460	27450	23750	25
30	20880	22760	22420	22400	22060	20950	18680	30
35		16570	16690	16900	16910	16300	14900	35
40		12200	12570	12900	13100	12820	11980	40
45			9480	9870	10190	10110	9650	45
50			7110	7520	7900	7940	7750	50
55			5310	5640	6040	6180	6170	55
60				4140	4530	4720	4850	60
65				2950	3270	3490	3720	65
70					2230	2450	2750	70
75					1370	1570	1900	75

22,000 lbs. cwt.		ON TIRES BOOM CENTERED ANSI B30.5		75% OVER FRONT	
BOOM LENGTH IN FEET - CAPACITY LISTED IN POUNDS					
RADIUS	35	55	72	RADIUS	
FT.					FT.
10	111980	92300			10
12	101420	92300	89800		12
15	88440	89760	89800		15
20	71830	73480	87890		20
25	59680	61520	72490		25
30	50360	52320	61010		30
35		45020	52190		35
40		39150	45260		40
45		34320	39590		45
50		20990	34860		50
55			31010		55
60			27660		60
65			24420		65

 22,000 lbs. ctwt.		360° ON TIRES ANSI B30.5		75%	360°
BOOM LENGTH IN FEET - CAPACITY LISTED IN POUNDS					
RADIUS	35	55	72	72	RADIUS
FT.					FT.
10	85430	74960			10
12	71180	63710	61540		12
15	55710	51100	49930		15
20	34270	35890	35260		20
25	21450	23230	23490		25
30	13630	15550	16220		30
35		10430	11290		35
40		6790	7740		40
45		4110	5060		45
50		3090	2990		50
55			1350		55

LOCATIONS



Global Equipment is the Exclusive Worldwide Distributor for Zoomlion Rough Terrain Cranes and all prices and availability will be negotiated with Global Equipment.



HEADQUARTERS

Global Machinery & Equipment, LLC
14800 Jersey Shore Drive,
Houston, TX 77047 USA
Toll Free: (866) 278-9780
Phone: +1 (713) 586-8808 | Fax: +1 (713) 586-8805
info@globalcranesales.com | www.globalcranesales.com

Uri Toudjarov

E-mail: uri@globalcranesales.com
Cell: +1 (602) 320-0762

Ed Gibson - North America

E-mail: egibson@globalcranesales.com
Direct: +1 (310) 749-0634

Due to constant improvement and engineering, we reserve the right to change the design, specifications, and equipment pricing without notification. Illustrations provided may or may not include all standard and optional equipment and accessories.