

HITACHI SUMITOMO

SCX800HD-2

HYDRAULIC CRAWLER CRANE

Specifications

ASIAN ISSUE



Specifications

HITACHI SUMITOMO

SCX800HD-2

Superstructure

UPPER REVOLVING FRAME:

All-welded, precision machined, robust construction. A machined surface provided for mounting load hoist, opt. 3rd drum and boom hoist assemblies, and mounting itself on turntable bearing.

TURNTABLE BEARING WITH INTERNAL SWING GEAR:

Single shear ball type; inner race of turntable bearing with integral, internal swing (ring) gear bolted to carbody frame, and outer race of turntable bearing bolted to upper revolving frame.

CONTROL SYSTEM:

System contains one set each of quadruplicate and triplicate tandem valves which direct oil to various machine function and are actuated by control levers via remote controlled hydraulic servo for all motions. Working speeds can be precisely controlled by pilot-operated armchair single axis control levers in cooperation with "EPC" controller that varies engine rpm and hyd. pump discharge simultaneously, or varies just hyd. pump discharge while keeping engine rpm via motorcycle type grip throttle. System also takes a specially-tailored unique hydraulic circuits to maximizes drum horsepower, and reduces horsepower loss with eliminating the possibility of engine stall.

Pump control system — By "EPC" controller that provides two modes of engine-pump control.

MODE I:

The "EPC" controller is normally programmed to vary the engine speed and pump discharge simultaneously. Simply twisting grip advances the engine to maximum speed and the hydraulic pumps to maximum flow at the same time. This mode is suitable to precision crane work.

MODE II:

By activating a switch, it is able to vary just the pump discharge according to grip throttle while keeping engine speed fixed. Mode II is convenient for duty cycle works such as clamshell operation, where the engine is normally run at full throttle.

A specially-tailored pressure compensating valve — Utilized in hydraulic circuits to realize a good minute operation of two main, and boom hoist drums.

HYDRAULIC SYSTEM:

System provided with three variable displacement axial piston pumps for both independent and combined operations of all functions, and one fixed displacement duplicate tandem gear pump for system valve and cylinder controls.

Main/aux. crane hoist motors — Variable displacement axial piston motor with counterbalance valve.

Boom hoist motor — Fixed displacement axial piston motor with counterbalance valve and spring-applied/power hydraulically released multiple wet-disc type automatic brake.

Third drum motor — Optional extra; variable displacement axial piston motor with counterbalance valve.

Swing motor — Fixed displacement axial piston motor with spring-applied/power hydraulically released multiple wet-disc type brake.

Travel motors — Shoe-in design; variable displacement axial piston motor with brake valve and spring-applied/power hydraulically released multiple wet-disc type automatic brake.

Oil cooler — Aluminum-make; available for not only a good rustproof but also high cooling efficiency.

Hydraulic oil reservoir — 450 liters capacity.

LOAD HOIST ASSEMBLY:

Front and rear main operating drums driven by independent hydraulic motor of bi-directional, variable displacement axial piston motor through a 2-stage planetary reduction gear unit powering the rope drum in either direction for hoisting and lowering load. Reduction gear unit installed within drum inside together with multiple wet-disc brake unit. Drum each sized in same dimension.

Brakes — Multiple wet-disc unit with negative brake design that takes the function of "spring-applied, power hydraulically released", and maintains a high brake safety even if a hydraulic pressure drop in the circuit happens; installed within drum inside together with shaft-coupled reduction gear unit. Eliminate clutch, and almost require no brake maintenance on this brake design.

Brake control — Applies dynamic hydraulic pressure for brake release operation with an extreme light pedaling force.

Brake mode — Available in two modes; one is automatic as suitable for liftcrane operation, and the other is free-fall mode as suitable for bucket operation. Free-fall interlocking is also designed for fail-safe operation.

A forced-oil cooling system — Available in both front and rear drum brake units to keep brake performance even in continuous duty cycle operations.

Drums — One piece, parallel grooved lagging with locking ratchet wheel cast integral; bolted to reduction gear unit. Available to wind up approx. 36m long cable of 26mm dia. at drum 1st layer.

Drum locks — Electrically operated pawl.

Drum rollers — Optional extra; available for right cable winding onto drums.

BOOM HOIST ASSEMBLY:

Driven by bi-directional, axial piston hydraulic

motor through 3-stage planetary reduction gear unit powering the rope drum in either direction for hoisting and lowering boom.

Brake — Spring-applied, power hydraulically released multiple wet-disc type automatic brake.

Drum rotation speed control — Max. rotation speed can be tuned according to arbitrary value that is electrically controlled by dialing, and then varies pump discharge.

Drum — One piece, parallel grooved lagging with locking ratchet wheel cast integral; bolted to reduction gear unit.

Drum lock — Power hydraulically operated pawl with automatic locking device.

THIRD DRUM WINCH MECHANISM:

Optional extra; available in almost same design as that of front and rear main operating winches except drum lagging width and flange diameter.

Brake — Multiple wet-disc unit with negative brake design as same as that of front/rear main operating winches.

Brake control — Applies dynamic hydraulic pressure for brake release operation as same as that of front/rear main operating winches.

Brake mode — Available in two modes of automatic and free-fall as same as that of front/rear main operating winches. Free-fall interlocking is also designed for fail-safe operation.

A forced-oil cooling system — Available to keep brake performance as same as that of front/rear main operating winches.

Drum — One piece, parallel grooved lagging as same as that of front/rear main operating winches, except drum lagging width and flange diameter.

Drum lock — Electrically operated pawl.

SWING:

Driven by a bi-directional, axial piston hydraulic motor through 2-stage planetary reduction gear unit powering swing pinion. Swing pinion meshes with internal teeth of swing (ring) gear of turntable bearing inner race.

Brakes — Spring-applied, power hydraulically released multiple wet-disc type; provided within hydraulic motor.

Swing speed control — Max. swing speed can be tuned according to arbitrary value that is electrically controlled by dialing, and then varies pump discharge.

Lock — Mechanically operated drop pin.

Speed — 5.1min^{-1} <5.1rpm>.

GANTRY:

A-frame type; raised and lowered by power hydraulic cylinders.

OPERATOR'S CAB:

A 2.3mm thickness steel plate construction with 940mm wide and a stamped-and-rounded corner designs; acoustically treated, full-vision, cushion rubber mounted, well-ventilated, full compartment, roomy operator's

cab with a large straighted front window with green-tinted safety glass; provided with an arrangement of "EPC" control/swing lever armchair control station, sunvisor, sunshade, rear-view mirrors, dual intermittent type window shield wipers with washer on both front and roof windows, sliding windows on both sides of cab, and swing-link type sliding door.

Instrument panel — Contains engine monitoring lamps, graphic display panel of Load Moment Indicator, gauges & meter, warning lamps and other necessary controllers and switches.

Operator's seat — Full adjustable reclining seat with head rest and both R/H and L/H side arm rests.

Anemometer — Optional extra; available for liftcrane attachment.

Air-conditioner — Optional extra.

Heater — Optional extra; hot water type.

Electric cab fan — Optional extra; wind-direction adjustable type.

Engine foot throttle — Optional extra: available for right-hand foot control.

Electric outlet — 24V; available in cab.

Operator's cab sidestep — Available for access ease to operator's cab.

AM/FM radio — Provided as std. with clock.

Fire extinguisher — Optional extra; powder type with 1kg capacity.

MACHINERY CAB:

Equipped with hinged doors on both sides for machinery access and inspection; affixed with tape-type non-skid material on the roof.

CATWALKS WITH RAILINGS:

Optional extra; hitched in place along both sides of machinery cab.

HYDRAULIC TAGLINE WINDER:

Optional extra; available for clamshell application. Provided in front of upper revolving frame for preventing a shake of suspended load by a 10mm dia. tug cable with light force.

COUNTERWEIGHTS:

Weights 28.2ton with a 3-cast iron block, removable, corner-rounded design. Three blocks consist of "A" (9,200kg), "B" (9,100kg) and "C" (9,900kg).

ELECTRICAL SYSTEM:

24-volt negative ground system; provided with two maintenance free batteries of 12V×150AH.

LIGHTING SYSTEM:

Includes following lights.

- Two 70 W working lights;
- One 10 W interior cab light.

SHAFTS AND PINS:

Most of shafts and pins used on superstructure are with zinc or nickel or chromiun plating for rustproof except A-frame gantry peak shaft.

POWER UNIT:

Make & Model	Isuzu 6HK1X
Type	Water-cooled, 4-cycle, direct injection, turbo-charged, diesel
No. of Cylinders	Six (6)
Bore & Stroke	115 mm × 125 mm
Displacement	7,790 cc
Rated Output	212 kW/2,000 min ⁻¹ 288 ps/2,000 rpm
Maximum Torque	1125 Nm/1,500 min ⁻¹ 115 kgf-m/1,500 rpm
Fuel Tank	415 liters

Note: 1. The engine meets Stage/Tier 3 of current smoke emission regulations in Europe, America and Japan.
2. A 212kW engine horsepower shown above is defined under a current international engine horsepower indication formula which includes necessary horsepower for engine alternator drive but excludes engine fan drive.

Undercarriage

CARBODY FRAME:

All-welded, precision machined, box type construction; provided with longer axle with folding type tips reaching up to axle box end of crawler side frame for better fitting between axle and crawler side frames. A machined surface provided for mounting turntable bearing.

CARBODY JACK-UP DEVICE:

Optional extra; contains four hydraulic jack cylinders with cylinder beams pinned to carbody frame for extending/retracting, and disassembling/assembling ease of crawler side frames.

Remote control box — Provided for controls of both carbody jack and crawler side frame removal cylinders when opt. carbody jack-up device is required.

Pontoon — All-welded construction; four pontoons each stored at an inside part of jack cylinder beams.

CRAWLER SIDE FRAMES:

All-welded, box type construction, precision machined; positioned on carbody frame axle beam, and held in place by plate links with pins.

Removal cylinder — Independently available on right- and left-hand crawler side frames for individually extending/retracting, and assisting in removing side frames. Controlled from operator's cab; if opt. carbody jack-up device is provided, its controls is from remote control box as an accessory of the carbody jack-up device.

Crawler side steps — Provided at both ends of the frames for easy access to superstructure.

CARBODY WEIGHT:

Weighs 4ton; 2ton each mounted at front and rear of the carbody.

DRIVE SPROCKETS:

Cast steel, heat treated; one per side frame. Track drive sprocket assembly bolt-coupled to 3-stage planetary reduction gear unit outer case as an integral part of shoe-in type traction motor. Sealed between parts of rotation and non-rotation of the motor with floating seal.

IDLER WHEELS:

Cast steel, heat treated; one per side frame. Mounted on two bronze bushings with floating seals for lifetime lubrication.

TRACK ROLLERS:

Ten per side frame; each heat treated cast steel with double flange design. All mounted on two bronze bushings with floating seals for lifetime lubrication.

CARRIER ROLLERS:

Two per side frame; each heat treated cast steel with double flange design. All mounted on two bronze bushings with floating seals for lifetime lubrication.

TRACKS:

Heat treated, self-cleaning, multiple hinged track shoes joined by full floating pins; 51 pcs. per side frame.

Shoe width — 800mm wide.

Track adjustment — Manual adjustment with oil jack and shim plate packs is standardized.

Automatic track tension adjusting device — Optional extra; available instead of std. track adjustment to always keep track tension at optimum level by means of power hyd. cylinder thru idler wheel actuated by power hydraulic supplied from superstructure.

TRAVEL AND STEERING:

A bi-directional, shoe-in type axial piston hydraulic motor bolt-couples with drive sprocket thru 3-stage planetary reduction gear unit outer case at each crawler side frame end for travel and steer. Straight-line travel (forward or reverse), pivot or differential turns, and counter-rotation for spin turns available.

Brake — Spring-applied, power hydraulically released multiple wet-disc type automatic brake; located within hydraulic motor. Brakes automatically set when travel levers are in neutral or when engine is shut down.

Travel speed — Two stages; 1.8/1.3km/hr. (based on flat, level and firm supporting surface, and under the conditions that no load must be applied and front-end att. must be the 9.5m basic boom only).

Gradeability — 30% (17°) permissible based on basic machine without front-end attachment.

Safety Devices

LOAD MOMENT INDICATOR:

This is a fully computerized automatic overload preventing system including total safe operation control system; provided with the designs of (1) no zero-point adjustment, (2) data input according to interface counter-indication/message on display panel, and (3) a graphic display panel with setting ease of viewing angle.

Construction (standard version) — Comprises (1) load detecting device with amplifier, (2) boom angle detector, (3) computerized Micro Processing Unit (M.P.U.), and (4) graphic display panel.

Functions — This system functions that if the lifting load reaches 90% of the rated one specified in the crane capacity chart, an intermittent pre-warning buzzer is given; if it is 100%, a warning is given by a continuous buzzer, and all peril side motions are automatically stopped. The machine, however, can be operated in safety side motions.

Display panel design — A graphic display panel is designed, and it is able to input necessary operating conditions/data according to interface counter-indication/message on the display panel, and the display panel indicates ten and some kinds of the present lifting and working conditions/data like “lifting load”, “max. allowable lifting load”, “working radius”, “max. allowable working radius”, “boom angle”, “load ratio”, “boom/jib lengths”, “engine rpm” and so on when working. In addition, the display panel is provided with three warning indicators over “engine over-heat”, “hyd. oil over-temp.” and “brake oil over-temp.”.

HOOK OVER-HOIST LIMITING DEVICE:

Limit switch type. Available to prevent hook over-hoisting with functions of automatic drum braking with hydraulic lock, and warning by buzzer.

BOOM OVER-HOIST AND -LOWERING LIMITING DEVICE:

Available in two kinds of devices; one is limit switch located on a part of boom foot for preventing boom over-hoisting, and the other is the safety function of the LMI available to automatically prevent boom over-hoisting and-lowering with the functions of automatic drum braking with hydraulic lock, and warning by buzzer. Further boom protection from rapid boom over-hoist by hook over-hoist motion under mal-function of hook over-hoist limiting device is available as one of functions of the LMI.

BOOM BACKSTOPS:

Dual; telescopic design with spring buffers.

DUAL BOOM OVER-HOIST LIMITING DEVICE:

Additional limit switch located on boom backstops; this is as a further safety device for redundant boom protection.

SWING LOCK:

Mechanically operated drop pin; available to firmly lock superstructure in four positions of facing front or rear or left or right to undercarriage.

DRUM LOCKS:

Electrically operated pawl locks is available on front and rear main drums while power hydraulically operated pawl lock is available on boom hoist drum with an automatic locking device as std.

THIRD DRUM LOCK:

Provided as std. when an optional 3rd drum winch is provided.

FREE-FALL INTERLOCKING DEVICE:

Available on both front and rear main drum brake lines for fail-safe operation. Functions that free-fall brake mode is only available when drum brake pedal is pressed even though brake mode is switched on free-fall mode.

NON-DRUM BRAKE PREVENTING DEVICE:

Available not to start engine whenever drum brake mode is in "free-fall".

SWING BRAKE SAFETY CIRCUIT:

Available not to start engine whenever swing brake is off.

BOOM ANGLE INDICATOR:

Pendulum type; mounted on right-hand side of bottom section of crane main boom.

HOOK LATCH:

Provided on every kinds of hook to prevent out of place of cable from hook.

LEVEL GAUGE:

Bubble type; located on operator's cab floor of superstructure.

CONTROL LEVER LOCKS:

Provided on all control levers (except swing lever) to lock levers in neutral.

SWING ALARM:

This is by buzzer, and flasher lamps located on both sides of machinery cab.

TRAVEL ALARM:

Available by an intermittent buzzer.

SPEED SLOWDOWN DEVICE:

This is for speed slowdown of hoisting and lowering motions of boom which are available just before automatic stopping at both upper and lower side limits of boom angle even though control lever(s) is still at hoisting/lowering position to prevent a shock.

SIGNAL HORN:

Available as warning just before every kinds of motions are initiated.

FOOL PROOF SHUT-OFF SYSTEM:

Located in the cab exit; this is available to automatically deactivate and lock hydraulic system.

FRONT-END ATT. ERECTION MODE:

This is an internal, integral function of the LMI. In the range out of crane working area, the LMI display panel automatically indicates "Now, out of crane working range" with a rigging instruction, and it is available to lift front-end att. off ground without the influence of LMI safety

functions, and, after front-end att. is lifted over the range of crane working area, LMI safety function gets back automatically for safe erection work. This function is also available for the work of vice-versa.

LMI SAFETY CIRCUIT-OFF SWITCH:

Available in key type for a good crane safety operation management without fail.

TRAVEL DIRECTION ARROW:

Attached each on crawler side frames.

GAUGES & METER:

Engine water temperature gauge, fuel gauge and hour-meter are provided on instrument panel.

WARNING LAMPS:

Available to let operator warn abnormal machine conditions as to pilot pressure and brake system of two main and opt. 3rd drums.; provided on instrument panel.

ENGINE MONITORING LAMPS:

Available to let operator warn engine abnormal conditions as to battery charge, lubrication oil pressure, radiator coolant level, air filter clogging, water temp., control unit and glow plug.; provided on instrument panel.

EMERGENCY ENGINE STOP SWITCH:

Located at cab instrument panel, and available to stop engine whenever it is necessary.

REAR VIEW MIRRORS:

Two; provided on front-left and -right corners of super-structure.

THREE COLOR PERCENTAGE INDICATOR:

Optional extra; this is with three colours of Green, Yellow and Red. Each colour indicates the load percentage to rated capacity; Green shows less than 90% as safety, Yellow shows 90 to 99% as marginal, and Red shows over 100% as over-loading. As further function, Red lamp comes on automatically when operator cuts off safety circuit of the LMI absent-mindedly.

LIFTING HEIGHT INDICATION DEVICE:

Optional extra; available to indicate lifting height above ground or depth below ground on display panel of the LMI. Also, hook hoisting speed slowdown function is available just before automatic stopping at a desired height under hook height setting before operation.

MICROPHONE & LOUD-SPEAKER:

Optional extra; this is for operator's convenience for loud speaking.

DRUM LIGHT & MIRROR:

Optional extra; these are available for checking rope winding onto front and/or rear drum(s).

AUX. CRANE HOOK OVER-HOIST LIMITING DEVICE:

Optional extra; this is available for auxiliary crane hoist with optional aux. short jib and/or fly jib. Performs the same function as that of "Hook over-hoist limiting device" mentioned before.

ANEMOMETER:

Optional extra; analogue type. Indicates wind velocity and alarms when the velocity exceeds a figure set.

Front-end Attachment

BOOM:

- Lattice construction, round tubular main chords, alloy, hi-ten steel, with bracing of round steel tubing.
- Boom connectionsIn-line pin connections at 1.40m deep and 1.40m wide.
- Basic boomTwo-piece, 9.5m basic length; 5.5m bottom and 4.0m tapered top sections.
- Boom head machineryFour head sheaves and two guide sheaves with rigid type rope guard. Sheaves all mounted on anti-friction bearings of conventional, non sealed-grease type.
- Boom extensionsOptional extra; available in 3.0m, 6.0m and 9.0m lengths with pendants.
- Maximum boom length54.5m for liftcrane application.
21.5m for clamshell application.

FLY JIB:

- Optional extra; lattice construction, round tubular main chords, alloy, hi-ten steel, with bracing of round steel tubing having in-line pin connections at 0.51m deep and 0.54m wide, and jib head machinery with single sheave mounted on antifriction bearings of conventional, non sealed-grease type. Provided with jib strut, jib backstops, and jib/boom guyline pendants. Mounted on 4.0m tapered crane top section, and available for light load lifting operation with less than 11ton with single part hoist line.
- Basic fly jibTwo-piece, 9.0m basic length; 4.5m bottom and top sections.
- Fly jib extensionsAvailable in 4.5m length with pendants.
- Maximum fly jib length18.0m.
- Boom plus fly jib lengthMax. 42.5m + 18.0m or 45.5m + 9.0m.

AUXILIARY SHORT JIB:

- Optional extra; all-welded construction having single sheave head machinery. Pinned to 4.0m tapered crane top section. Available for 11ton lift as maximum with single part hoist line.

HOOK BLOCKS:

- Sheaves all mounded on anti-friction bearings. Available in 4 kinds of capacities as under:
- 80t, four sheavesOptional extra.
- 50t, two sheavesOptional extra.
- 30t, one sheaveOptional extra.
- 11t, ball hookOptional extra.

BAIL AND BRIDLE:

- All-welded construction; provided with larger sheaves of a 21.0 D/d ratio on both bail and bridle for 12-part boom hoist rope reeving. Bail pinned to A-frame gantry, and bridle suspended between a 12-part boom hoist rope and pendant ropes connecting to tip of 4.0m tapered crane top section. Sheave all mounted on anti-friction bearings of conventional, non sealed-grease type.

DRUM DATA:

Drum	Root dia.	Type	Line speed (Hoisting, Lowering)	Cable	Max. line pull
Front (main crane hoist) (clamshell bucket holding) (hammer grab crown holding via hook) (MHL/MEH bucket hoist)	554mm	Parallel grooved	110 ~ 2mpm	26.0mm	196kN 20t
Rear (aux. crane hoist) (clamshell bucket closing) (hammer grab holding & closing) (MHL/MEH bucket hoist)	554mm	Parallel grooved	110 ~ 2mpm	26.0mm	196kN 20t
Boom hoist	450mm	Parallel grooved	68 ~ 2mpm	16mm	104kN 10.6t
Optional 3rd	554mm	Parallel grooved	110 ~ 2mpm	26.0mm	196kN 20t

Notes:

1. Line speed is based on drum first layer and rated engine rpm.
2. Hoisting line speed varies under load and operating conditions.

HOIST REEVING:

Kind of hook block	(t)								
	No. of partline	8	7	6	5	4	3	2	1
80t		80.0	77.0	66.0	55.0	44.0	—	—	—
50t		—	—	—	50.0	44.0	—	—	—
30t		—	—	—	—	—	30.0	22.0	—
11t		—	—	—	—	—	—	—	11.0

CABLES:

- Front drum.....3×F(40), 26mm dia./175m long, breaking load 568kN 58.0t .
- Rear drum.....Optional extra; 3×F(40), 26.0mm dia./150m long, breaking load 568kN 58.0t .
- Boom hoist drum.....IWRC 6×P•WS (31), 16mm dia./150m long, breaking load 219kN 22.3t .
- Optional 3rd drum.....Optional extra; 3×F(40), 26.0mm dia., breaking load 568kN 58.0t . Length depends on request.

Liftcrane 80 metric tons

LIFTCRANE CAPACITIES:

Boom length (m) Working Radius(m)	9.5	12.5	15.5	18.5	21.5	24.5	27.5	30.5	33.5	36.5	39.5	42.5	45.5	48.5	51.5	54.5
3.40	80.00															
3.50	76.50	70.60/3.9														
4.00	70.00	69.50														
4.50	62.30	62.15	62.00													
5.00	56.30	56.15	56.00	54.20												
5.50	51.35	51.20	50.90	48.50	46.25/5.6											
6.00	46.40	46.30	45.85	43.85	42.00	40.00/6.1	39.10/6.7									
7.00	36.80	36.80	36.80	36.75	36.70	36.65	36.60	35.05/7.2	31.15/7.8							
8.00	30.40	30.40	30.35	30.30	30.25	30.15	30.15	30.05	30.05	28.40/8.3	26.05/8.8					
9.00	25.85	25.80	25.75	25.70	25.60	25.55	25.50	25.40	25.40	25.30	25.20	23.55/9.4	20.40/9.9			
10.00	24.05/9.5	22.35	22.30	22.25	22.15	22.10	22.05	21.95	21.90	21.85	21.75	21.65	20.35	17.50/10.5	14.75/11.0	12.40/11.6
12.00		17.60	17.50	17.45	17.35	17.25	17.20	17.10	17.05	17.00	16.85	16.75	16.75	16.65	14.35	12.25
14.00		17.40/12.1	14.30	14.25	14.10	14.05	14.00	13.85	13.85	13.75	13.65	13.50	13.50	13.40	13.30	11.55
16.00			13.40/14.7	11.95	11.85	11.75	11.70	11.55	11.50	11.45	11.30	11.20	11.20	11.10	11.00	10.85
18.00				10.80/17.3	10.10	10.05	9.95	9.85	9.80	9.70	9.60	9.45	9.45	9.35	9.25	9.15
20.00					8.85/19.9	8.70	8.65	8.50	8.45	8.35	8.25	8.10	8.10	8.00	7.90	7.75
22.00						7.65	7.55	7.45	7.40	7.30	7.15	7.05	7.00	6.90	6.80	6.70
24.00						7.40/22.5	6.70	6.55	6.50	6.40	6.30	6.15	6.10	6.05	5.90	5.80
26.00							6.30/25.1	5.85	5.80	5.70	5.55	5.45	5.40	5.30	5.20	5.05
28.00								5.35/27.7	5.15	5.05	4.95	4.80	4.75	4.65	4.55	4.45
30.00									4.65	4.55	4.40	4.30	4.25	4.15	4.05	3.90
32.00									4.55/30.3	4.10	3.95	3.85	3.75	3.70	3.55	3.45
34.00										3.90/32.9	3.55	3.45	3.35	3.30	3.15	3.00
36.00											3.30/35.5	3.10	3.00	2.90	2.75	2.60
38.00												2.80	2.70	2.55	2.40	2.25
40.00												2.80/38.1	2.35	2.25	2.10	1.90
42.00													2.25/40.7	1.95	1.80	1.60
44.00														1.80/43.3	1.55	1.35
46.00															1.35/45.9	1.30/45.0

WORKING MASS & GROUND PRESSURE:

Shoe width	Mass	Pressure
800mm	76.3t	91.0kPa <0.93kg/cm²>

Note: Working mass shown above is with 9.5m basic boom, 28.2ton counterweight, 4ton carbody weight and optional 80t hook block.

Notes — Liftcrane capacities

1. Ratings in this lifting capacity charts are shown in accordance with Japanese Construction Codes for Mobile Cranes and Japanese Safety Ordinance on Cranes, e.t.c.
2. Capacities included in this chart are the maximum allowable, and are based on machine standing level on firm supporting surface under ideal job conditions.
3. Capacities are in metric tons, and are not more than 78% of minimum tipping loads except the figures surrounded by bold lines which are based on other factor of machine structural strength limitation.
4. Capacities are based on freely suspended loads and make no allowance for such factors as the effect of wind, sudden stopping of loads, supporting surface conditions, and operating speeds. Operator must reduce load ratings to take such conditions into account. Deduction from rated capacities must be made for mass of hook block, weighted ball/hook, sling, spreader bar, or other suspended gear.
Hook block mass is as follows:
80t.....1.05ton 50t0.90ton 30t0.73ton
11t.....0.37ton
5. All capacities are rated for 360° swing.
6. Least stable rated condition is over the side.
7. A 28.2ton counterweight is required for all capacities on this chart. A 4ton carbody weight is necessary too.
8. Crawler side frame must be fully extended for all operating conditions.
9. Attachment must be erected and lowered over the ends of the crawler mounting.
10. Main boom length must not exceed 54.5m.
Maximum fly jib length permitted — 18.0m.
Maximum boom and fly jib combination length permitted — 42.5m+18.0m or 45.5m+9.0m.
Maximum boom length when mounting auxiliary short jib is 48.5m.
11. Capacities when handling load off main boom head sheaves in case of mounting fly jib or auxiliary short jib on top of boom are detailed; if required, please consult us or nearest distributor.

SCX800HD-2 AUXILIARY SHORT JIB CAPACITIES: Max. 11t

Note: Jib capacities is almost equal to the figures made by the deduction of a 300kg from the liftcrane capacities for boom length up to 48.5m unless restricted by the maximum jib capacity shown above. As to the details, please consult us or nearest distributor.

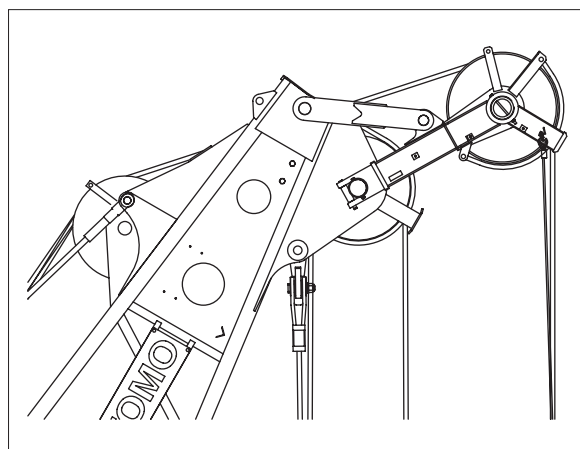

Auxiliary short jib (Option)

Fly Jib Capacities

Boom length(m)	27.5						30.5					
Jib length(m)	9.0		13.5		18.0		9.0		13.5		18.0	
Jib offset angle(°)	10	30	10	30	10	30	10	30	10	30	10	30
Working radius(m)												
9.6	11.00											
10.0	11.00		11.00/11.2				11.00/10.2		11.00/11.8			
12.0	11.00	11.00/12.3	11.00		6.80/12.8		11.00	11.00/12.9	11.00		6.75/13.3	
14.0	11.00	10.70	11.00	7.80/15.3	6.70		11.00	10.90	11.00	7.80/15.8	6.75	
16.0	11.00	10.00	11.00	7.60	6.40		11.00	10.25	11.00	7.75	6.50	
18.0	10.05	9.40	10.20	7.10	6.15	4.75/18.2	9.90	9.65	10.05	7.25	6.25	4.75/18.7
20.0	8.65	8.90	8.80	6.70	5.90		8.50	8.80	8.70	6.85	6.00	4.65
22.0	7.55	7.75	7.70	6.35	5.65	4.50	7.40	7.65	7.60	6.50	5.75	4.50
24.0	6.65	6.85	6.80	6.00	5.45	4.35	6.50	6.70	6.65	6.20	5.55	4.40
26.0	5.95	6.05	6.05	5.75	5.25	4.25	5.80	5.95	5.90	5.90	5.40	4.30
28.0	5.30	5.40	5.45	5.50	5.10	4.15	5.15	5.30	5.30	5.50	5.20	4.20
30.0	4.75	4.85	4.90	5.05	4.95	4.00	4.60	4.75	4.75	4.95	4.85	4.10
32.0	4.30	4.35	4.45	4.55	4.50	3.80	4.15	4.25	4.25	4.45	4.35	3.95
34.0	3.95/33.8	3.95	4.00	4.15	4.10	3.70	3.75	3.80	3.85	4.00	3.95	3.80
36.0		3.85/34.4	3.65	3.75	3.75	3.55	3.40	3.45	3.50	3.60	3.60	3.65
38.0			3.35	3.40	3.40	3.45	3.35/36.4	3.30/37.0	3.20	3.30	3.25	3.45
40.0				3.25/38.9	3.15	3.25			2.90	3.00	3.00	3.10
42.0					2.90	2.95			2.85/40.6	2.75/41.5	2.75	2.85
44.0					2.85/42.3	2.75/43.4					2.50	2.60
46.0											2.40/44.9	2.35

Boom length(m)	33.5					
Jib length(m)	9.0		13.5		18.0	
Jib offset angle(°)	10	30	10	30	10	30
Working radius(m)						
9.6						
10.0	11.00/10.7					
12.0	11.00	11.00/13.4	11.00/12.3		6.75/13.9	
14.0	11.00	11.00	11.00		6.75	
16.0	11.00	10.45	11.00	7.80/16.3	6.60	
18.0	9.80	9.90	10.00	7.40	6.35	4.70/19.3
20.0	8.45	8.75	8.60	7.00	6.10	4.70
22.0	7.35	7.60	7.50	6.65	5.85	4.55
24.0	6.45	6.65	6.60	6.35	5.65	4.45
26.0	5.70	5.90	5.85	6.05	5.50	4.35
28.0	5.05	5.20	5.20	5.45	5.30	4.25
30.0	4.50	4.65	4.65	4.90	4.75	4.15
32.0	4.05	4.15	4.20	4.40	4.30	4.05
34.0	3.65	3.75	3.75	3.95	3.85	3.90
36.0	3.30	3.35	3.40	3.55	3.50	3.70
38.0	3.00	3.05	3.10	3.20	3.15	3.35
40.0	2.85/39.0	2.80/39.6	2.80	2.90	2.90	3.05
42.0				2.55	2.60	2.75
44.0			2.40/43.2	2.35	2.40	2.50
46.0				2.35/44.1	2.15	2.25
48.0					2.00/47.5	2.00
50.0						1.95/48.6

Boom length(m)	36.5						39.5					
Jib length(m)	9.0		13.5		18.0		9.0		13.5		18.0	
Jib offset angle(°)	10	30	10	30	10	30	10	30	10	30	10	30
Working radius(m)												
11.3	11.00						11.00/11.8					
12.0	11.00		11.00/12.9				11.00		11.00/13.4			
14.0	11.00	11.00	11.00		6.75/14.4		11.00	11.00/14.5	11.00		6.75/15.0	
16.0	11.00	10.65	11.00	7.75/16.9	6.65		11.00	10.85	11.00	7.75/17.4	6.70	
18.0	9.70	10.10	9.90	7.55	6.40	4.70/19.8	9.60	9.95	9.75	7.65	6.50	
20.0	8.35	8.65	8.50	7.15	6.20	4.70	8.20	8.55	8.40	7.25	6.25	4.70/20.4
22.0	7.25	7.50	7.40	6.80	5.95	4.60	7.10	7.40	7.25	6.95	6.05	4.60
24.0	6.35	6.55	6.50	6.50	5.75	4.50	6.20	6.45	6.35	6.60	5.85	4.50
26.0	5.60	5.80	5.75	6.05	5.60	4.40	5.45	5.65	5.60	5.95	5.70	4.40
28.0	4.95	5.10	5.10	5.35	5.20	4.30	4.80	5.00	4.95	5.25	5.05	4.30
30.0	4.40	4.55	4.55	4.80	4.65	4.20	4.25	4.45	4.40	4.65	4.50	4.25
32.0	3.95	4.05	4.05	4.30	4.15	4.15	3.80	3.95	3.95	4.15	4.05	4.15
34.0	3.55	3.65	3.65	3.85	3.75	4.00	3.40	3.50	3.50	3.75	3.60	3.90
36.0	3.20	3.25	3.30	3.45	3.40	3.65	3.05	3.15	3.15	3.35	3.25	3.50
38.0	2.85	2.95	2.95	3.10	3.05	3.25	2.70	2.80	2.85	3.00	2.90	3.15
40.0	2.55	2.65	2.70	2.80	2.75	2.95	2.35	2.45	2.50	2.70	2.65	2.85
42.0	2.35/41.6	2.35	2.40	2.55	2.50	2.65	2.10	2.15	2.20	2.40	2.35	2.55
44.0		2.30/42.2	2.15	2.25	2.25	2.40	1.85	1.90	1.95	2.10	2.05	2.30
46.0			1.95/45.8	2.00	2.00	2.15	1.80/44.2	1.80/44.8	1.70	1.80	1.80	2.00
48.0				1.90/46.7	1.80	1.90			1.50	1.55	1.60	1.75
50.0					1.60	1.65			1.45/48.4	1.45/49.3	1.40	1.50
52.0					1.55/50.1	1.55/51.2					1.30/51.3	1.30

Boom length(m)	42.5					
Jibl ength(m)	9.0		13.5		18.0	
Jib offset angle(°)	10	30	10	30	10	30
Working radius(m)						
11.3						
12.0	11.00/12.4		11.00/13.9			
14.0	11.00	11.00/15.1	11.00		6.75/15.5	
16.0	11.00	11.00	11.00		6.70	
18.0	9.45	9.90	9.65	7.75	6.55	
20.0	8.05	8.45	8.25	7.40	6.35	4.70/20.9
22.0	6.95	7.30	7.15	7.05	6.15	4.65
24.0	6.05	6.35	6.25	6.65	5.95	4.55
26.0	5.30	5.55	5.45	5.85	5.60	4.45
28.0	4.70	4.90	4.85	5.15	4.95	4.35
30.0	4.15	4.35	4.30	4.55	4.40	4.30
32.0	3.65	3.85	3.80	4.05	3.90	4.20
34.0	3.25	3.40	3.40	3.60	3.50	3.80
36.0	2.90	3.00	3.00	3.25	3.10	3.40
38.0	2.55	2.65	2.70	2.90	2.80	3.05
40.0	2.20	2.30	2.35	2.55	2.45	2.75
42.0	1.90	2.00	2.05	2.25	2.15	2.45
44.0	1.65	1.75	1.80	1.95	1.90	2.15
46.0	1.40	1.50	1.55	1.70	1.65	1.85
48.0	1.35/46.8	1.30/47.4	1.35	1.45	1.45	1.60
50.0			1.30/48.5	1.30/49.2	1.30/49.2	1.40
52.0						1.30/50.8

Boom length(m)	45.5	
Jib length(m)	9.0	
Jib offset angle(°)	10	30
Working radius(m)		
12.0	10.60/12.9	
14.0	10.40	10.70/15.6
16.0	10.10	10.60
18.0	9.40	9.85
20.0	8.00	8.40
22.0	6.90	7.25
24.0	6.00	6.30
26.0	5.25	5.50
28.0	4.60	4.85
30.0	4.05	4.25
32.0	3.60	3.75
34.0	3.20	3.35
36.0	2.75	2.95
38.0	2.40	2.55
40.0	2.10	2.20
42.0	1.80	1.90
44.0	1.50	1.60
46.0	1.30	1.35
48.0		1.30/46.4

Notes — Fly jib capacities

1. Ratings in this lifting capacity charts are shown in accordance with Japanese Construction Codes for Mobile Cranes and Japanese Safety Ordinance on Cranes, e.t.c.
2. Capacities included in these charts are the maximum allowable, and are based on machine standing level on firm supporting surface under ideal job conditions.
3. Capacities are in metric tons, and are not more than 78% of minimum tipping loads except the figures surrounded by bold lines which are based on other factor of machine structural strength limitation.
4. Capacities are based on freely suspended loads and make no allowance for such factors as the effect of wind, sudden stopping of loads, supporting surface conditions, and operating speeds. Operator must reduce load ratings to take such conditions into account. Deduction from rated jib capacities must be made for weight of hook block, weighted ball/hook, sling, spreader bar, or other suspended gear. Hook block weight is as follows;
11t.....0.37ton
5. All capacities are rated for 360° swing.
6. Least stable rated position is over the side.
7. A 28.2ton counterweight and 1.5ton aux.weight (or opt.3rd drum) are required for all capacities on these charts. A 4ton carbody weight is necessary too.
8. Crawler side frame must be fully extended for all operating conditions.

9. Attachment must be erected and lowered over the ends of the crawler mounting.
10. Maximum fly jib length permitted is 18.0m, and maximum boom and fly jib combination length permitted is 42.5m boom plus 18.0m fly jib or 45.5m boom plus 9.0m fly jib.

Liftcrane Working Ranges

Hook left allowance height

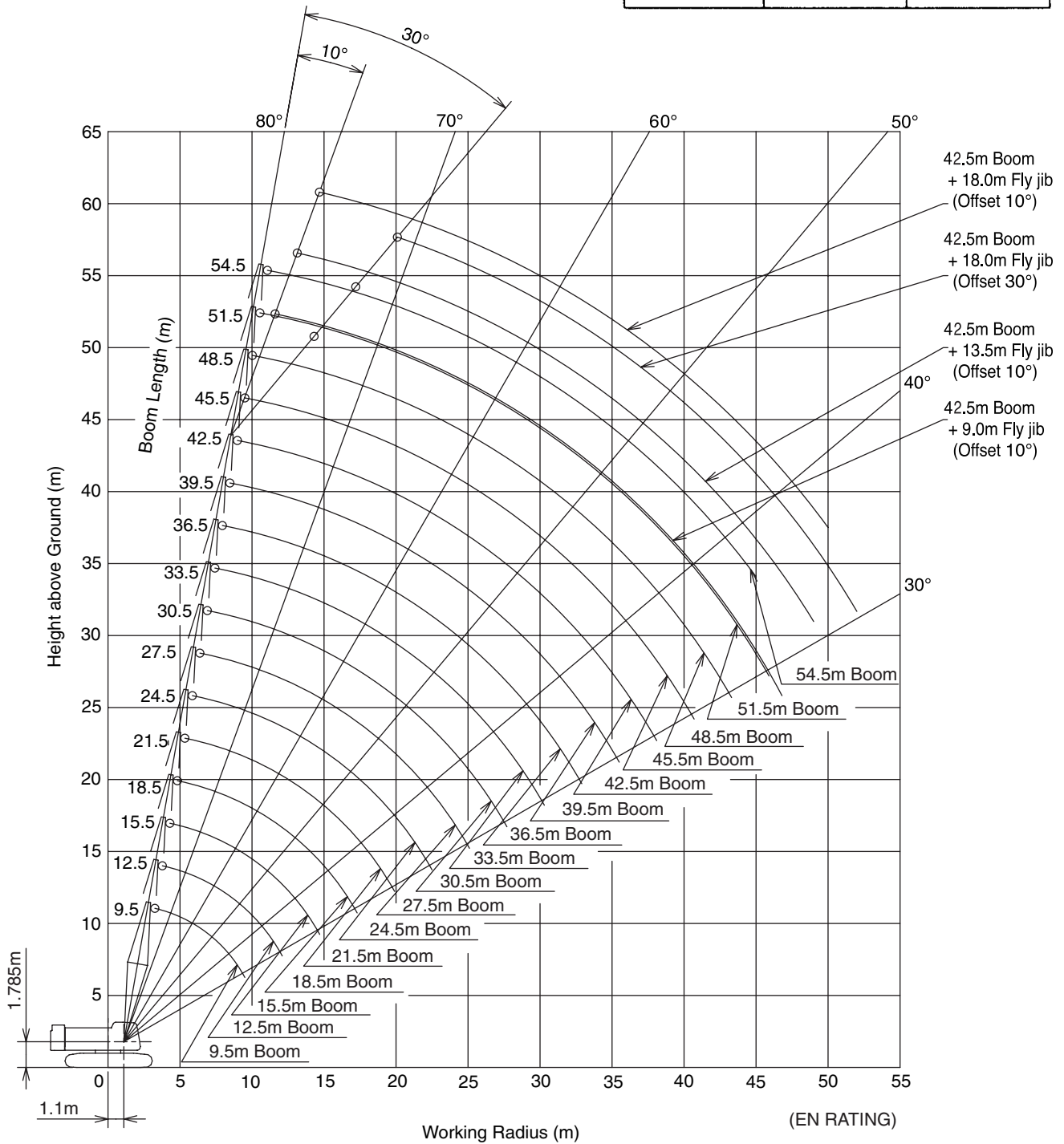
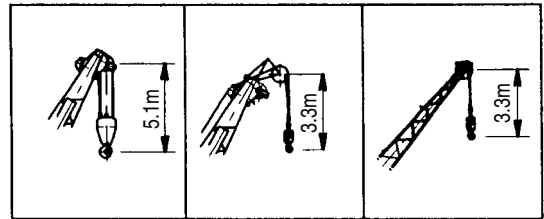

Clamshell 2.5m³ over

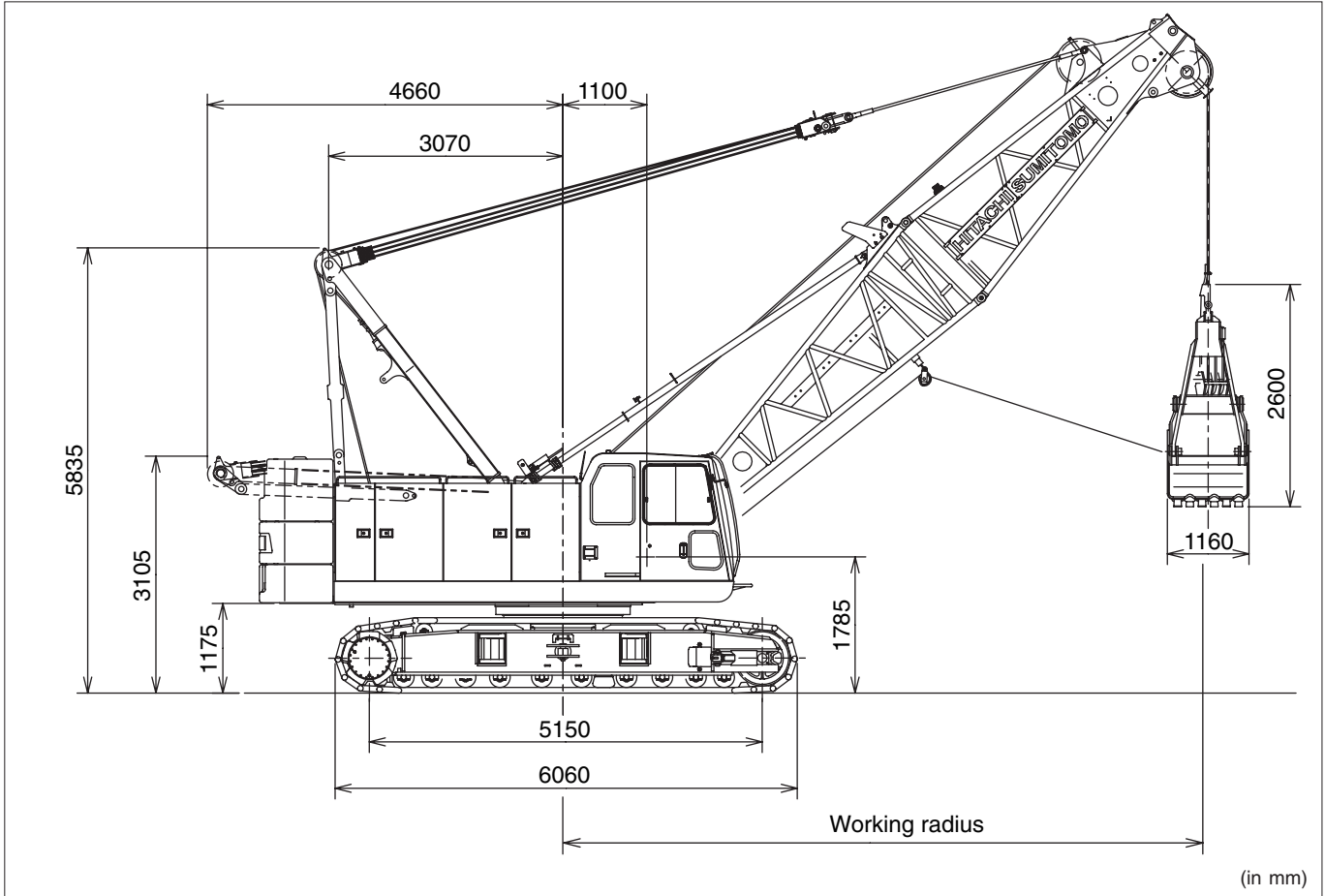

CLAMSHELL RATINGS:

(in metric tons)

Boom length (m) Working radius (m)	9.5	12.5	15.5	18.5	21.5
3.4	10.00				
3.5	10.00	10.00/3.90			
4.0	10.00	10.00			
4.5	10.00	10.00	10.00		
5.0	10.00	10.00	10.00	10.00	
5.5	10.00	10.00	10.00	10.00	10.00/5.80
6.0	10.00	10.00	10.00	10.00	10.00
7.0	10.00	10.00	10.00	10.00	10.00
8.0	10.00	10.00	10.00	10.00	10.00
9.0	10.00	10.00	10.00	10.00	10.00
10.0	10.00/9.5	10.00	10.00	10.00	10.00
12.0		10.00	10.00	10.00	10.00
14.0		10.00/12.10	10.00	10.00	10.00
16.0			10.00/14.70	10.00	10.00
18.0				10.00/17.30	9.50
19.9					8.25

Notes:

1. Max. clamshell rating is 10.5t.
2. Mass of bucket plus load should not exceed clamshell ratings shown above. Following data are for a general digging application buckets.

Bucket capacity	2.0m ³	2.5m ³
Bucket mass	4.5t	5.5t

3. Boom length shall not exceed 21.5m.
4. Apparent specific gravity of lifting material:
Earth1.7~1.8t/m³
Gravel1.8~2.0t/m³
5. High gantry is required and side frame must be fully extended for all operating conditions. Also, 28.2t counterweight, and 4ton carbody weight are required for all clamshell ratings shown above.
6. Max. digging depth below ground shall be 36m.

WORKING MASS & GROUND PRESSURE:

Shoe width	Mass	Pressure
800mm	81t	96kPa <0.98kg/cm ² >

Note: Working mass shown above is with 9.5m boom, 28.2ton counterweight, 4ton carbody weight, hydraulic tagline winder and 2.5m³/5.5t clamshell bucket.

BUCKET DIMENSIONS:

(in m)

	2.0m ³	2.5m ³
A Bucket overall height (opened)	4.59	5.13
B Bucket overall height (closed)	3.78	4.18
C Bucket opening width	3.24	3.63

Notes:

1. Buckets of 2.0/2.5m³ are for a general excavating purpose.
2. Other type of bucket than above is also available.

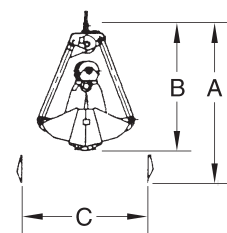

General Dimensions

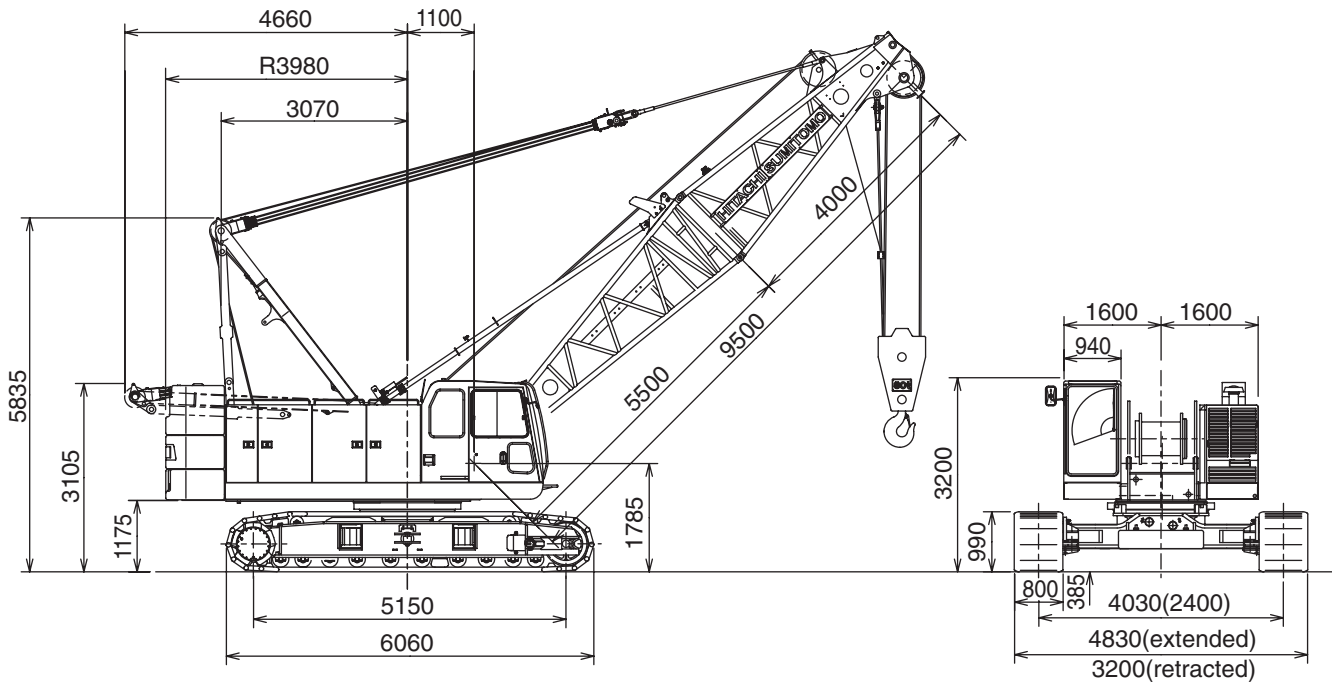





(in mm)

- Notes:** 1. The above general arrangement is under liftcrane application with 9.5m basic boom and optional 80t hook block.
 2. Radius of rear end of the counterweight is 3,980mm.

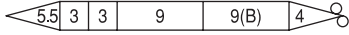
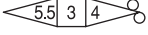
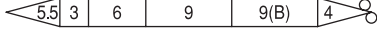
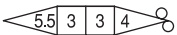
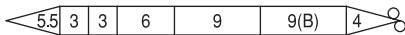
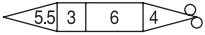
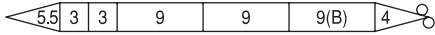
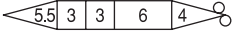
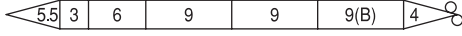
Boom & Fly Jib Combination Diagram

Crane Boom Combination

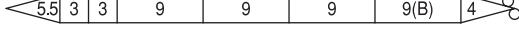
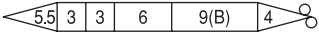
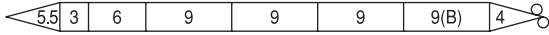
Boom Length (m)	Boom Combination	Boom Length (m)	Boom Combination
9.5		33.5	
12.5		36.5	
15.5		39.5	
18.5		42.5	
21.5		45.5	
24.5		48.5	
27.5		51.5	
30.5		54.5	

Notes : The meanings of figures and symbols shown above are as follows:.

 : 5.5m bottom section

 : 3.0m boom extension

 : 4.0m tapered top section



 : 6.0m boom extension

 : 9.0m boom extension

 : 9.0m boom extension (for use with fly jib)

Auxiliary short jib is able to attach on boom ranging from 9.5m thru 48.5m in length:

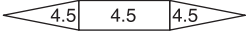
Fly Jib Combination (Available offset angle : 10 & 30 degrees):

Jib Length (m)	Jib Combination
9.0	
13.5	
18.0	

Note : The meanings of figures and symbols shown above are as follows:.

-  : 4.5m top section
  : 4.5m jib extension
 : 4.5m bottom section

Boom Plus Fly Jib Combination Table (Available offset angle : 10 & 30 degrees):

Boom Length (m)	9.5	12.5	15.5	18.5	21.5	24.5	27.5	30.5	33.5	36.5	39.5	42.5	45.5	48.5	51.5	54.5
Jib Length (m)	9.0	x	x	x	x	x	x							x	x	x
	13.5	x	x	x	x	x	x						x	x	x	x
	18.0	x	x	x	x	x	x						x	x	x	x

Note : In case that fly jib is attached, kind of boom extension should be 9m(B). (○ : possible × : impossible)

Transport Data

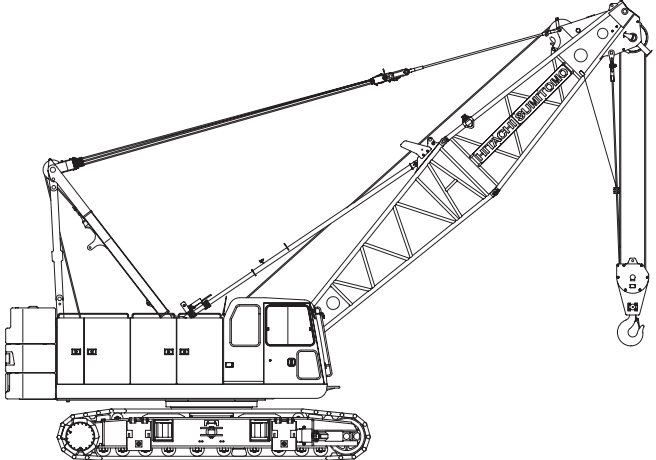
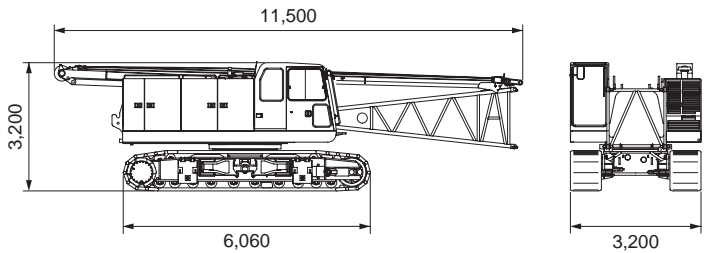
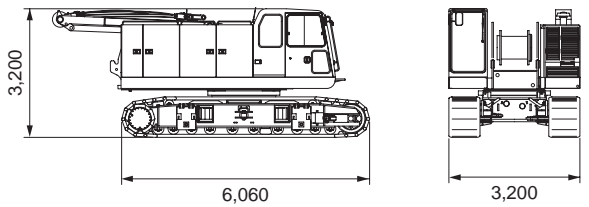
Description	Qty	Dimension(mm)	Mass(kg)
<p>General Arrangement (w/liftcrane att.)</p>	<p>1</p>	 <p>(w/9.5m basic boom and 80t hook block)</p>	<p>76,100</p>
<p>Basic Machine with: Boom base section; Front drum rope; A-frame gantry w/bridle; Boom hoist drum rope; Crawler side frames; Carbody weight;</p>	<p>1</p>		<p>45,500</p>
<p>Basic Machine with: Front drum rope; Boom hoist drum rope; Crawler side frames; A-frame gantry w/bridle; Carbody weight;</p>	<p>1</p>		<p>44,200</p>

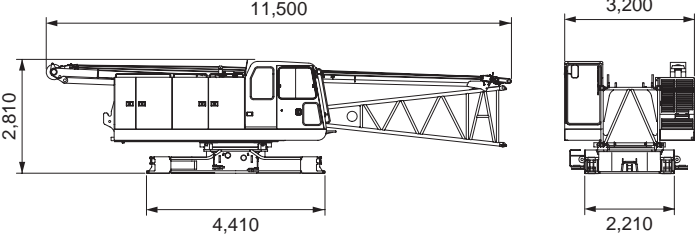
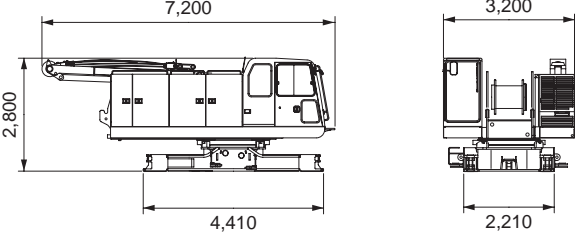
Description	Qty	Dimension(mm)	Mass(kg)
Superstructure with: Boom base section; Front drum rope; A-frame gantry w/bridle; Boom hoist drum rope;	1		26,200
Superstructure with: Front drum rope A-frame gantry w/bridle; Boom hoist drum rope;	1		25,000

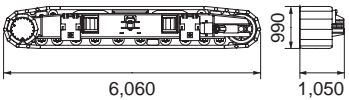
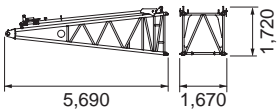
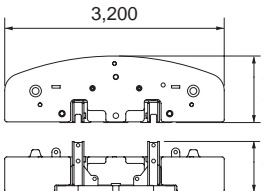
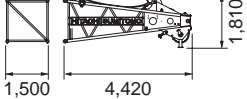
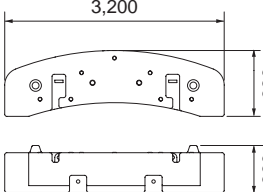
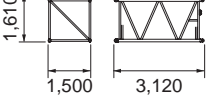
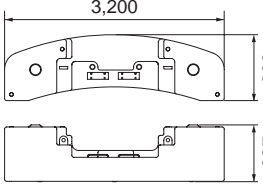
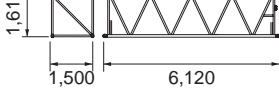
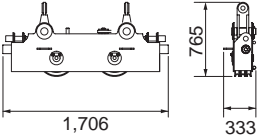
Description	Qty	Dimension	Mass(kg)	Description	Qty	Dimension	Mass(kg)
Crawler side frame	2		7,650 x 2	Boom Base Section (w/backstops)	1		1,200
Counterweight (A)	1		9,200	Boom Top Section	1	 (w/pendant ropes)	1,340
Counterweight (B)	1		9,100	3m Boom Extension	1	 (w/out pendant ropes)	330
Counterweight (C)	2		9,900	6m Boom Extension	1	 (w/out pendant ropes)	540
Bridle	1		280	/			

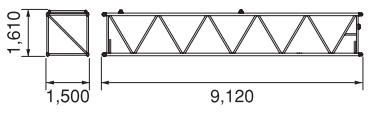
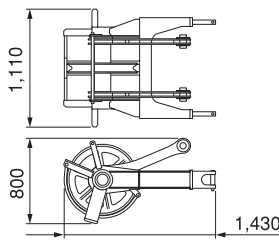
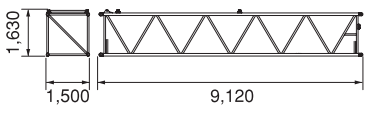
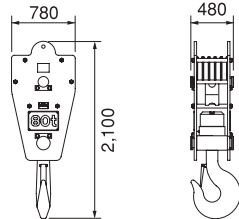
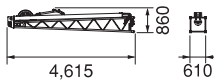
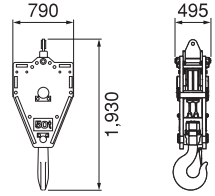
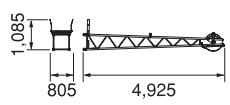
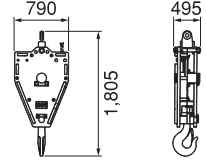
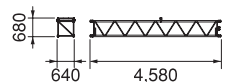
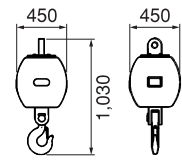
Description	Qty	Dimension	Mass(kg)	Description	Qty	Dimension	Mass(kg)
9m Boom Extension	1	 <p>(w/out pendant ropes)</p>	750	Aux Short Jib	1		400
9m(B) boom Extension	1	 <p>(w/out pendant ropes)</p>	750	80t Hook Block	1		1,050
Jib Base section (w/jib strut)	1		480	50t Hook Block	1		900
Jib Top section	1		250	30t Hook Block	1		730
4.5m Jib Extension	1		140	11t Ball Hook	1		370

Standard and Optional Equipment

	Standard equipment	Optional equipment
Superstructure	<ul style="list-style-type: none"> ● Isuzu 6HK1X diesel engine with an 212kW <288ps> rated output; ● Hydraulic system with three variable displacement axial piston pumps and one fixed displacement duplicate tandem gear pump; provided with aluminum-make oil cooler; ● Control system with one set each of quadruplicate and triplicate tandem valves and pilot-operated arm chair single axis control levers; provided with "EPC" controller (easy-precise-minute engine rpm and hyd. pump oil flow control device), and specially-tailored pressure compensating valves; ● Front and rear main operating drum winches of 196kN 20t line pull with 554mm dia. drum lagging driven by independent variable displacement hyd. motor; provided with multiple wet-disc type brake installed within drum inside together with reduction gear unit with negative brake design, brake release control under dynamic hyd. pressure, and a forced-oil cooling system. IAvailable to operate in two brake modes of automatic and free-fall; ● Boom hoist mechanism driven by hyd. motor with automatic brake; provided with multiple wet-disk type automatic brakel; ● Swing mechanism with turntable bearing; driven by one hyd. motor w/spring-applied, power hydraulically released multiple wet-disc brake; provided with speed control device; ● Power hydraulically retractable A-frame gantry; ● 940mm wide, full-vision operator's cab with a stamped-and-rounded corner design and large front window; provided with an arrangement of armchair operator control station and instrument panel; ● 28.2ton counterweight; ● Machinery cab with hinged doors; ● 24-volt electrical system with two 12-volt batteries; ● Lighting system: <ul style="list-style-type: none"> • Two 70W working lights; • One 10W interior cab light; ● Accessories: <ul style="list-style-type: none"> • AM/FM radio w/clock; • Engine hourmeter; • Engine tachometer;indicated on display panel of LMI; • Fuel gauge; • Eng. water temp. gauge; • Engine over-heat indicator; available on display panel of LMI; • Hyd. oil over-temp. indicator; available on display panel of LMI; • Brake oil over-temp. indicator; available on display panel of LMI; • 24V electric outlet; • Dual, intermittent window shield wipers with washers; available on both front and roof windows; • Cigar lighter; • Ash tray; • Book holder; • Sunvisor; • Sunshade; • Cup Holder; • Non-skid surfaces; • Cab front step; • Cab sidestep; • Cab floor mat; • Superstructure under-cover. ● Std. spare parts and tools. 	<ul style="list-style-type: none"> ● Third drum winch; ● Third drum cable; ● Hyd. tagline winder; available for clamshell application; ● Fairlead; available for dragline application; ● Drum rollers; available on front/rear main drums; ● Fire extinguisher; ● Catwalks with railings along both sides of machinery cab; ● Built-in type full air-conditioning; ● Re-fuel pump; ● Heater; ● Electric cab fan. ● Engine foot throttle.

	Standard equipment	Optional equipment
Undercarriage	<ul style="list-style-type: none"> ● 4,030mm gauge by 6,060mm long crawler lower with power hydraulically retractable/extendible crawler side frames; ● Crawler drive units with shoe-in type traction motor with wet-disc type automatic brakes; ● 800mm wide track shoes; ● Manual track tension adjusting devices; ● Lifetime lubricated track components; ● 4ton carbody weight; ● Crawler side steps. 	<ul style="list-style-type: none"> ● Carbody jack-up device w/4-vertical hyd. jack-up cylinder and remote control unit; ● Automatic track tension adjusting device, i/o manual one as std.
Liftcrane Att.	<ul style="list-style-type: none"> ● 9.5m basic boom; 5.5m bottom section, and 4.0m tapered top section; ● Four boom head sheaves w/two guide sheaves and rigid type cable guard; ● Bail and bridle assemblies; ● Main crane hoist cable; 26.0mm dia./175m long; ● Boom hoist cable; 16mm dia./150m long. 	<ul style="list-style-type: none"> ● 3.0m boom extension; ● 6.0m boom extension; ● 9.0m boom extension; ● 9.0m basic fly jib; 4.5m bottom and top sections with strut and guyline pendants; ● 4.5m fly jib extension; ● Auxiliary short jib; ● 80t hook block; ● 50t hook block; ● 30t hook block; ● 11t ball hook; ● Aux. crane hoist cable, 26.0mm dia./150m long; ● Heavy duty, single head sheave w/a guide sheave and roller type rope guard; available for exclusive dragline application; ● Boom skywalk; available for all sections of liftcrane main boom.
Luffing Towercrane Att.		—To be advised later —
Safety Devices	<ul style="list-style-type: none"> ● Load Moment Indicator; this is a computerized automatic over-load preventing system incl. total safe operation control system; provided with a graphic display panel indicating ten and some kinds of present lifting conditions; ● Main and aux. drum pawl locks; ● Boom hoist drum pawl lock (w/automatic locking device); ● Swing lock; ● Swing alarm; ● Travel alarm; ● Hook over-hoist limiting device; ● Boom over-hoist and -lowering limiting device; ● Dual boom over-hoist limiting device; ● Boom backstops; ● Speed slowdown device; ● Boom angle indicator; ● Level gauge; fitted on floor of operator's cab; ● Warning lamps; available for pilot line and brake system; ● Non-drum brake preventing device; ● Swing brake safety circuit; ● Signal horn; ● Hook latch; ● Control lever locks; ● Fool proof shut-off system; ● Engine monitoring lamps; ● Rear view mirrors; ● Free-fall interlocking device; ● Travel direction arrow; ● Emergency engine stop switch; ● Front-end att. erection mode; ● LMI safety circuit-off switch. 	<ul style="list-style-type: none"> ● Lifting height indication device; ● Aux. hook over-hoist limiting device; ● Three color percentage indicator; ● Microphone & loud-speaker; ● Drum light & mirror.

SCX800HD-2



Hitachi Sumitomo Heavy Industries Construction Crane Co.,Ltd.

12-14, Ueno 7-chome, Taito-ku, Tokyo 110-0005, Japan

Phone: 81-3-3845-1387 Facsimile: 81-3-3845-1394

<http://www.hands-crane.com>

- We are constantly improving our products and therefore reserve the right to change designs and specifications without notice.
- Units in this specification are shown under International System of Units; the figures in parenthesis are under Gravitational System of Units as old one.

Address Inquires to: