

Link-Belt®

Hydraulic Self-Propelled Crane

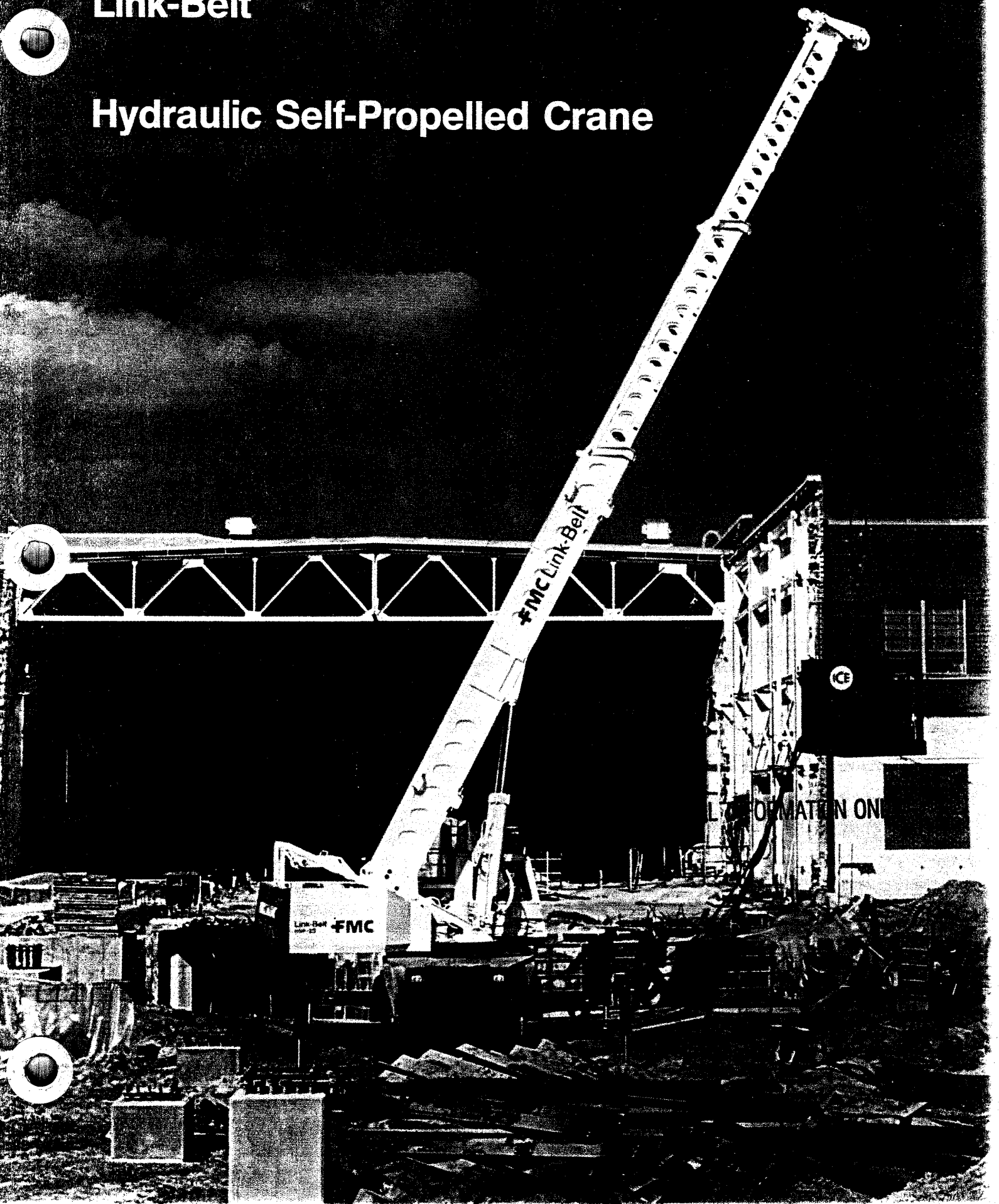

FMC's new hydraulic self-propelled crane with flat deck carrier design

Results in greater travel and operating stability

FMC now offers an additional model to the mid-size hydraulic self-propelled crane class, the HSP-25, a 25-ton (22.68 metric ton) machine. The FMC designed and manufactured carrier features a flat deck design. Major components are mounted low in the frame, resulting in a lower center of gravity for greater travel and swing stability and increased on-tire lifting capacity in the operating ranges. The practical design of the flat deck carrier also permits operator cab access throughout the 360° swing of the crane upper.

Removal of the engine panels on the flat deck reveals a low mounted engine

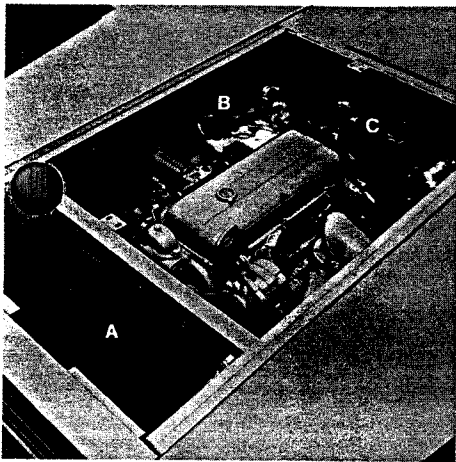

Engine assembly

assembly which includes an oil cooler (A) as standard. The air cylinder (B) regulates the throttle of the engine. In addition to providing a smooth acceleration and deceleration of the

engine, the control provides a high idle engine speed for initial engine start-up and can be set to remain at any engine RPM level during machine operation. A centralized circuit-breaker panel (C) provides for an instant status check of the major electrical systems in the carrier. Push-button breakers allow for easy reset of all the circuits, eliminating time consuming fuse replacement. An engine mounted air compressor provides power for brakes, throttle, transmission shift, and disconnects for the main pumps and the rear axle drive.

Engine radiator and transmission are rubber shock-mounted to the frame.

The HSP-25 carrier not only provides for a lifting base, but also for optimum maneuverability in congested areas. The carrier is equipped with an automatic shift transmission controlled by a single lever. An air cylinder shifts the transmission from reverse to the forward speeds.

For added safety and minimum effort, 2-wheel, 4-wheel and crab-style steering

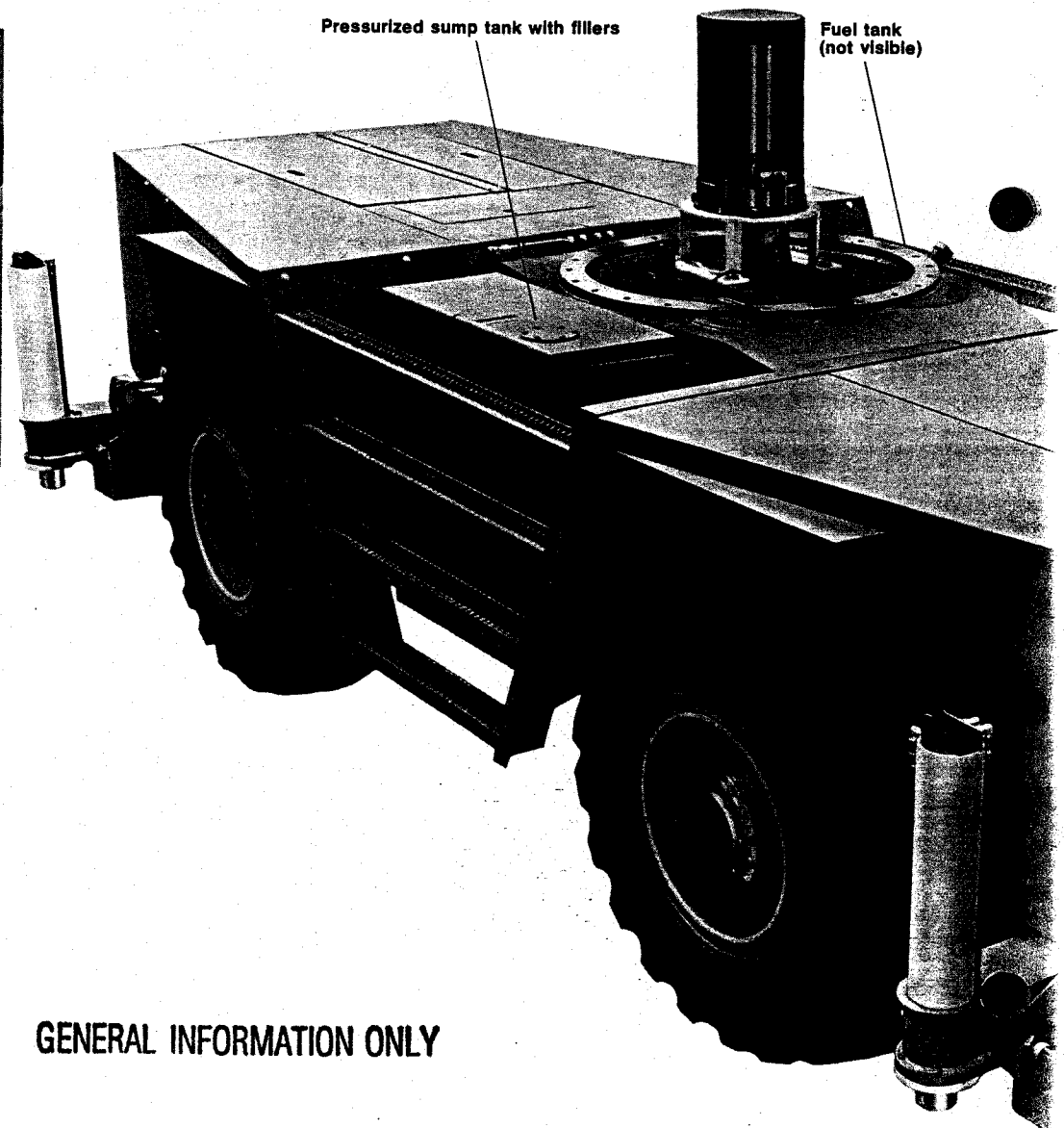

GENERAL INFORMATION ONLY

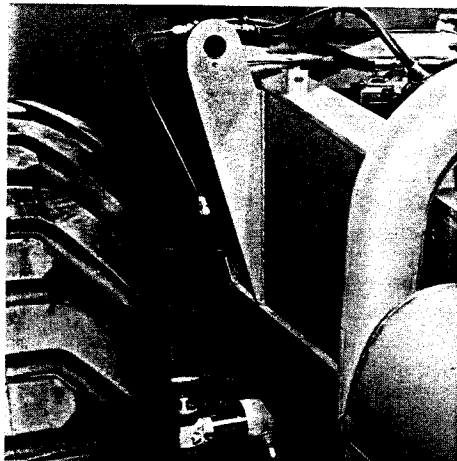

Rear axle oscillation

are all coordinated with the steering wheel. A steering mode selection switch, plus a visual rear wheel position indicator, are all conveniently located for the operator in the control console.

The HSP-25 rear axle oscillates when travelling over uneven ground to

maintain tire traction. For a more rigid lifting base, when swinging beyond 15° either side of center, the rear axle is automatically locked in position by two large hydraulic cylinders. An operator controlled lock-out override allows for oscillation adjustment, if necessary.

The low, in-line, carrier power train concept of the HSP-25 is a simple efficient design. A unique offset drive system enables the engine to be mounted low in the frame while still maintaining a direct in-line drive to the transmission. The transmission powers the front axle for 2-wheel drive operation, and by activating a control console mounted switch, an air actuated clutch permits power to be supplied to

the standard driving rear axle for 4-wheel drive operation.

The front and rear planetary drive axles are each equipped with a high traction differential. They allow one wheel to assume up to 60% of the available axle torque for traction on uneven ground.

The crane upper is mounted to the carrier by a turntable bearing with integral swing gear.

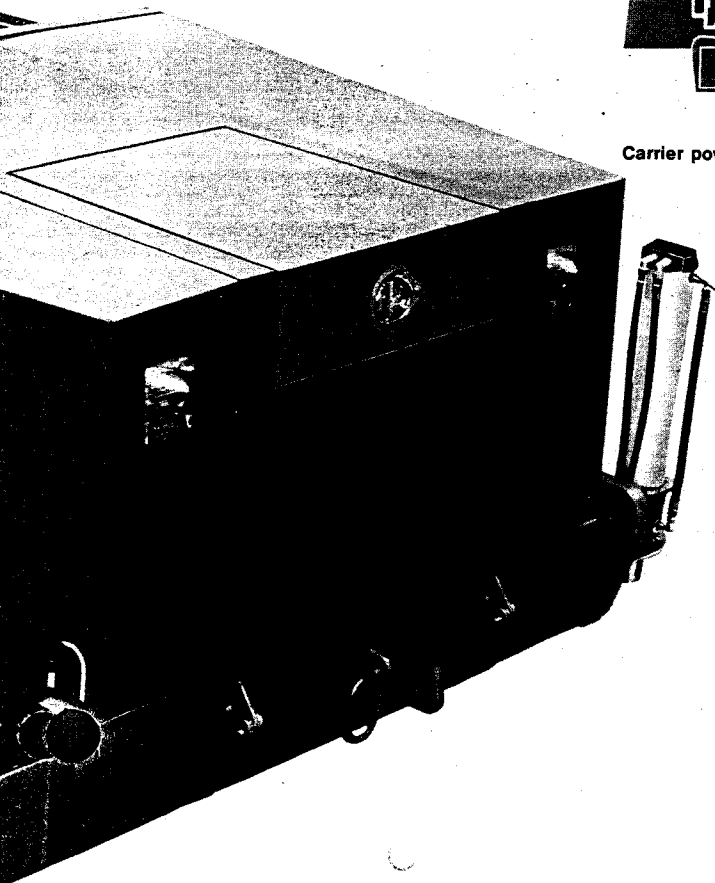
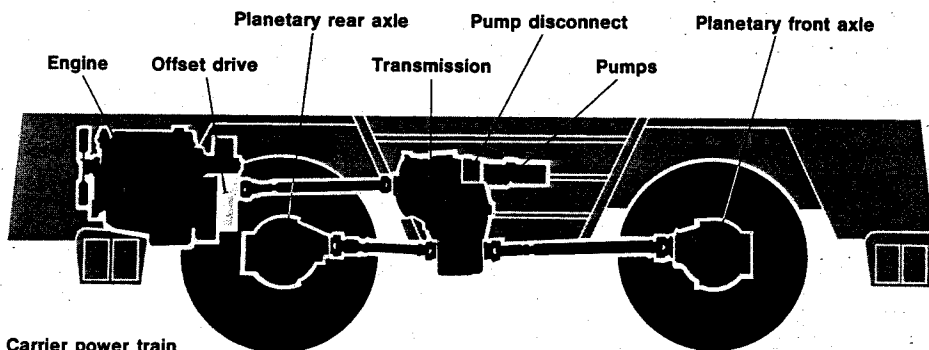

Jack cylinder check valve (p-7)

GENERAL INFORMATION ONLY

Extended, low profile revolving upperstructure with accessible rope drums

Modular, humanized, and stylized operator's cab

The HSP-25 revolving upperstructure design introduces a new concept to the hydraulic self-propelled crane user. Following the same concept of the carrier, the major components are mounted inside the extended, low profile frame. This lowers the crane's center of gravity for greater stability and lifting capacity. It also provides increased accessibility to the rope drums and components.

To obtain an optimum weight to strength ratio the entire upper frame was subjected to an extensive testing program in the FMC Applied Mechanics Laboratory. Powerful hydraulic rams apply real-life loadings to simulate the stress imposed under actual crane working conditions. Strain gauges applied directly to the metal surface detect the strain as force is applied to the structure. The strain data is then recorded through the use of sophisticated, sensitive acquisition systems. The elaborate program helps to assure users of a superior/total product.

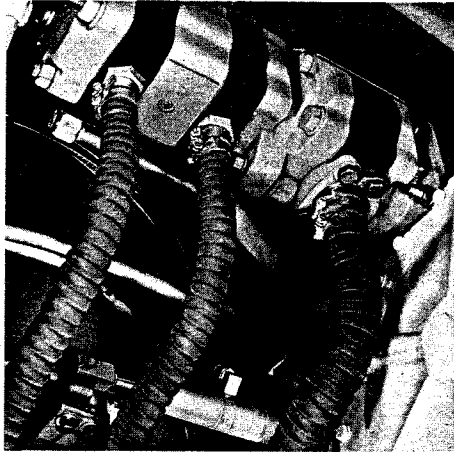

Hydraulic pumps

The hydraulic power for the upperstructure functions is provided by gear-type hydraulic pumps driven off an extended engine/transmission shaft in the carrier. A cab controlled, air actuated pump disconnect is standard.

Power for the two low mounted rope drums (A) is from the bi-directional motors (B) into the planetary reduction unit (not visible) which is mounted inside and connected to the rope drum. An automatic spring applied, hydraulically released load holding brake (C) is standard. Holding valve (D) which is directly connected to the motor prevents uncontrolled load lowering. High-speed

Sliding rear window

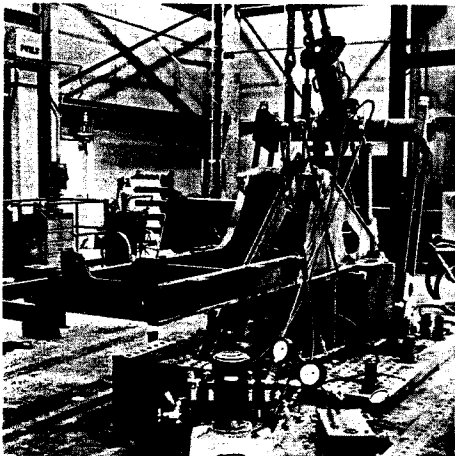

Upper in Applied Mechanic's Laboratory

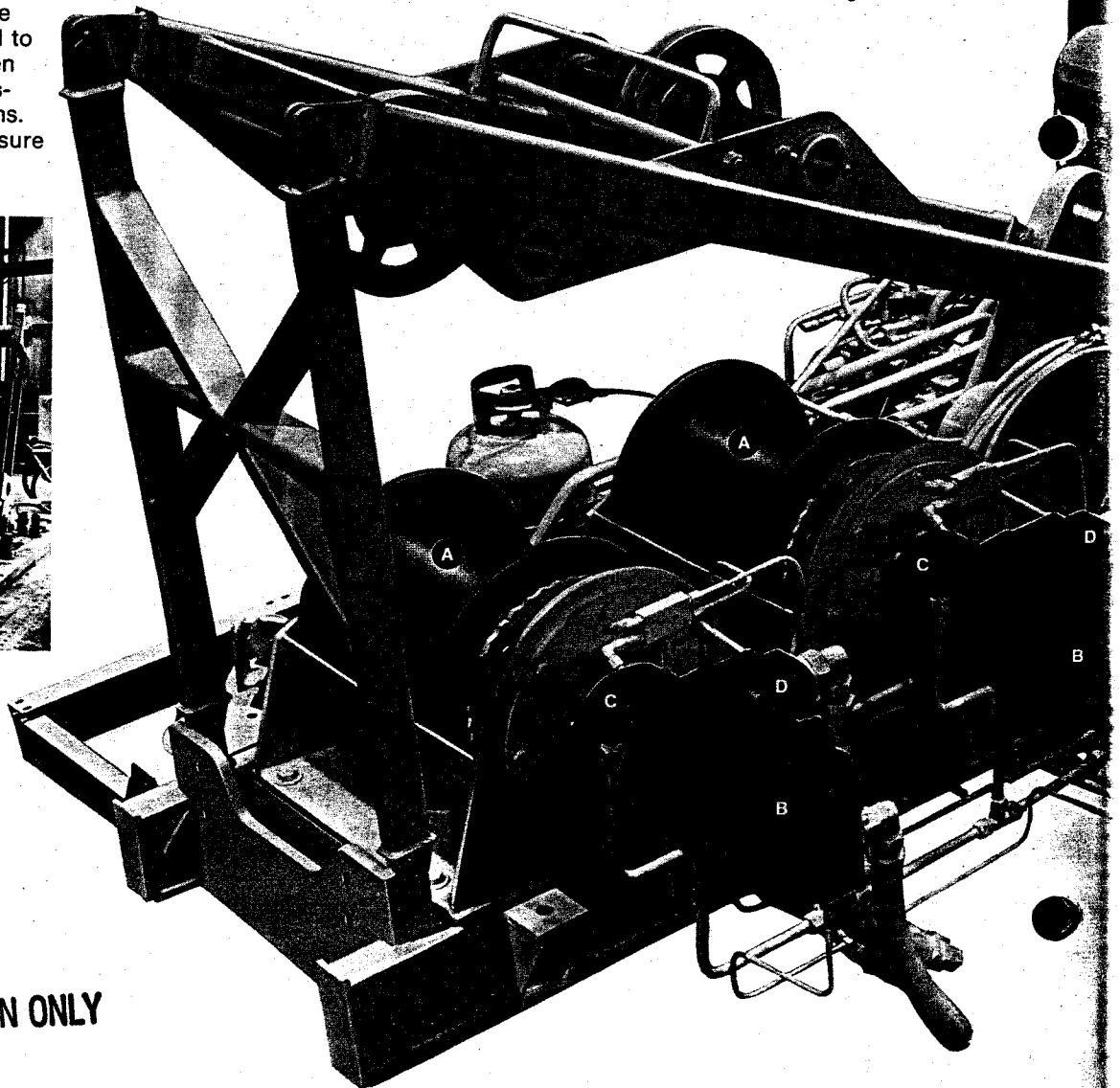

GENERAL INFORMATION ONLY

Hinge roof window

Removable front window

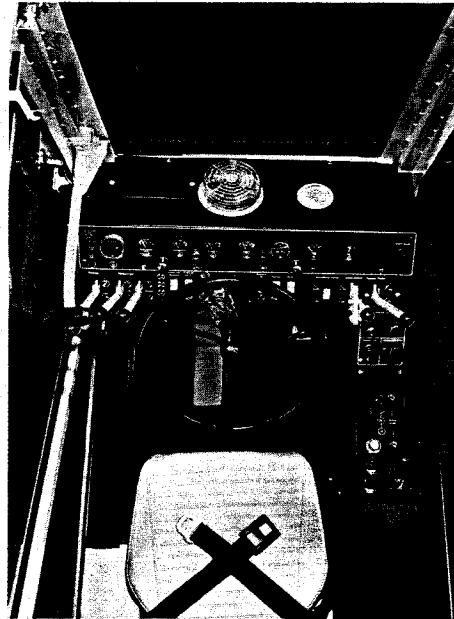
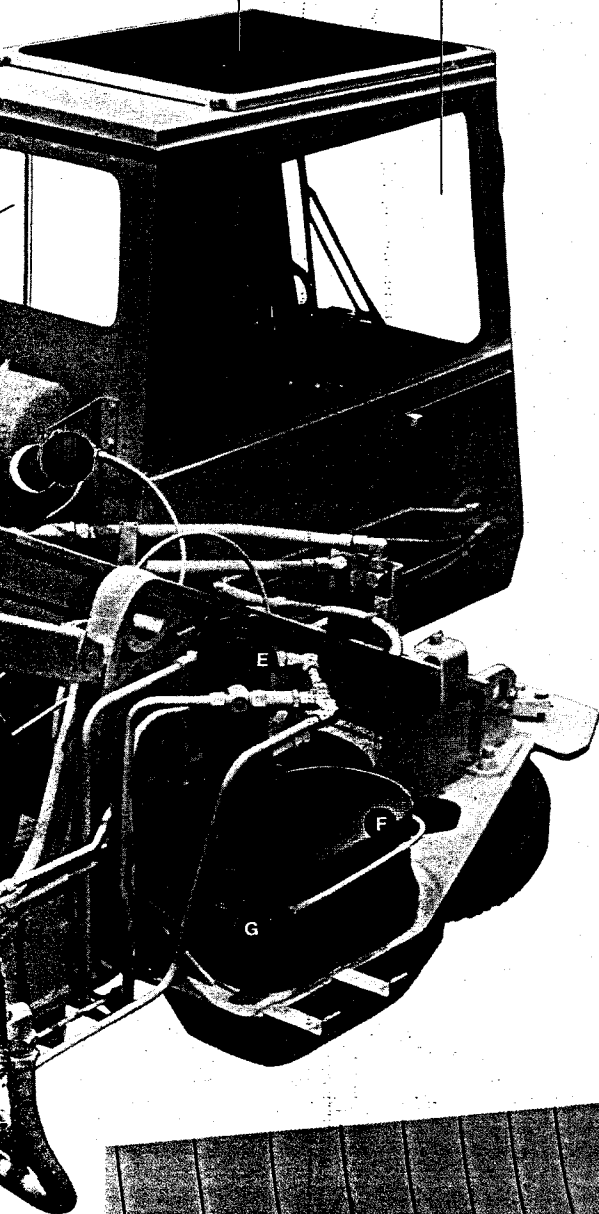

Operator's cab



Boom length Indicator

design engineering group. Directly in front of the operator is the luxurious yet functional control console with full complement of instruments. Conveniently

located control lever for the crane functions are to the right and left of the steering wheel. Control console includes boom angle indicator, hydraulic pump disconnect, and rear axle drive disconnect. Transmission shift lever and swing brake lever are located to the right of the operator. An electric **boom length indicator** is optional. For operating visibility and comfort, the cab is equipped with a **sliding rear window**, **hinged roof window**, and a **removable front window**. The cab is rubber-mounted to the frame. Interior cab insulation is standard.

load hoist is standard on the main drum and auxiliary drum (optional).

The 360° swing power is from the bi-directional tandem gear-type motor (E) into the FMC reduction unit (F) and then into the swing shaft/pinion. "Free-swing" or "metering swing speed" is possible. Results in smooth swing acceleration and deceleration, and permits centering of the boom over the load before the load is lifted. A manually controlled swing brake (G) plus a pin-type swing lock is standard. A 360° swing lock is also available.

The modular and humanized operator's cab is the result of FMC's styling and

The practical design of the low-profile crane upper mounted on a flat deck carrier is an ideal combination for an operator to have **unobstructed visibility** when operating over the front, rear or sides.

Rope drums (A)

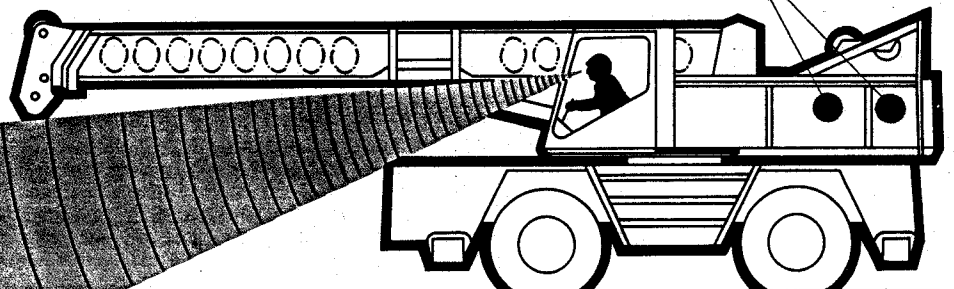

Unobstructed visibility

GENERAL INFORMATION ONLY

Exclusive boom design embossed with diamond-shaped depressions

Custom machine tools assure precision and dependability

GENERAL INFORMATION ONLY

The 3-section power boom design is an exclusive FMC engineering achievement. With the aid of the Applied Mechanics Laboratory and extensive testing, the **boom design (patented)** was developed to consist of minimum gauge side plates along with 100,000 p.s.i. (689 500 kPa) yield strength steel angles in the four corners resulting in a more durable boom.

To maintain the tolerances and precision established by engineering, FMC made a considerable investment in custom designed machine tools and an all new facility for manufacturing the boom.

The side plates are embossed with a 1200-ton (1 088 metric ton) **hydraulically operated press**. The embossing of the minimum gauge boom side plates increases the strength and stiffness while keeping the weight at a minimum. The **diamond shaped depressions** were added to the design to allow for the normal flow of boom stresses (both

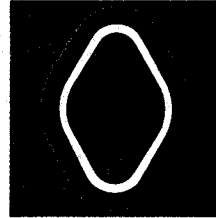
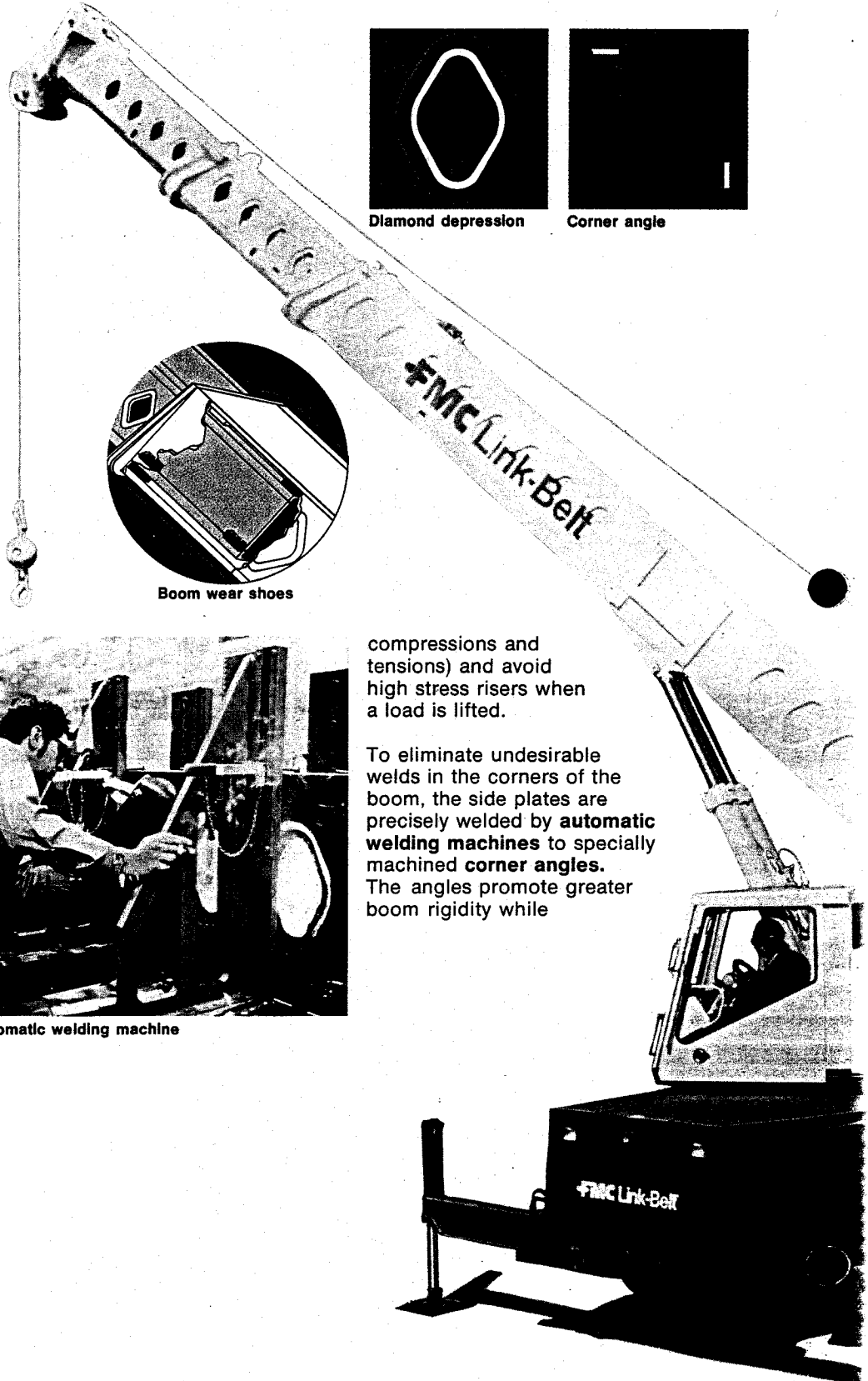

Diamond depression

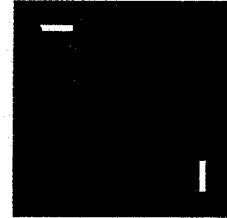

Corner angle

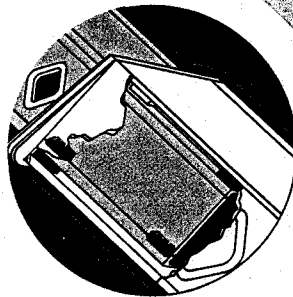

Boom wear shoes

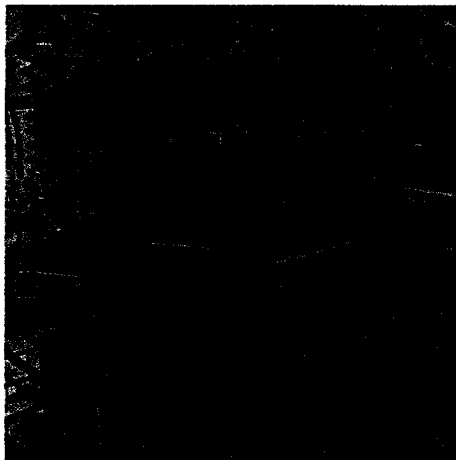

Hydraulically operated press

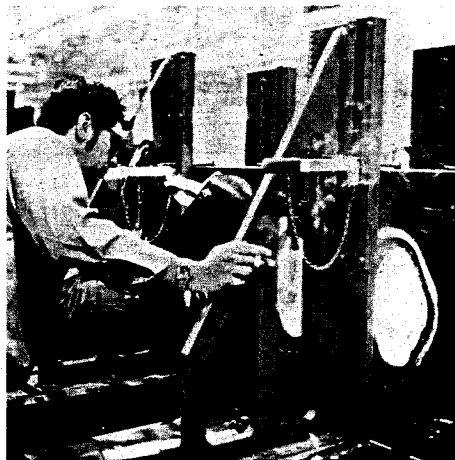

Automatic welding machine

compressions and tensions) and avoid high stress risers when a load is lifted.

To eliminate undesirable welds in the corners of the boom, the side plates are precisely welded by **automatic welding machines** to specially machined **corner angles**. The angles promote greater boom rigidity while

GENERAL INFORMATION ONLY

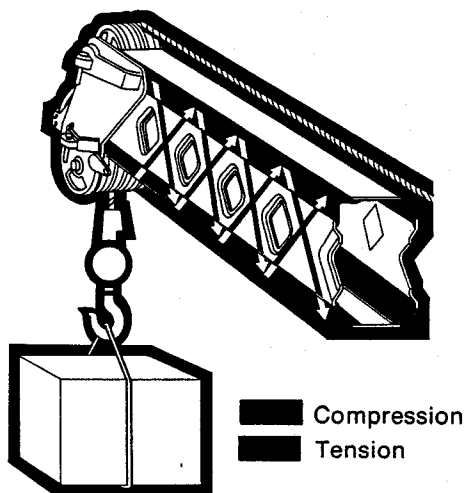

FMC's exclusive boom design (patented)

increasing the overall reliability. The corner angles are able to absorb and efficiently transmit the boom stresses which occur when lifting a load.

To maintain proper alignment of the power boom sections, the FMC boom design incorporates the use of **wear shoes** which are positioned on the top, bottom and sides of each power

section. All of the shoes are readily accessible for serviceability. The rear wear shoes are lubricated through external fittings located at the head of each section. It is not necessary to dismantle the boom for wear shoe replacement.

The total power boom length is 28' 6" - 70' (8.69 - 21.34 m). Also available is a 25' (7.62 m) swing around lattice fly or with an additional 20' (6.10 m) lattice section, a 45' (13.72 m) jib.

Hydraulic out-and-down outriggers are standard. Beams are full width with individual controls for extending the beams and lowering the jacks. **Outrigger controls** are conveniently located under the right arm-rest in the operator's cab. Once the outriggers are set, an automatic check valve attached directly to the jack cylinder "locks" oil in the cylinder to secure the jack in place. The two-position **floats** are pinned to the jacks.

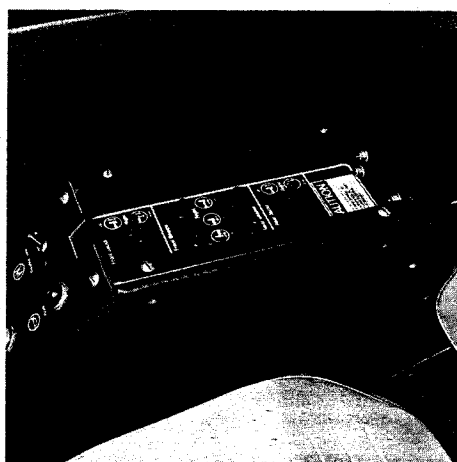
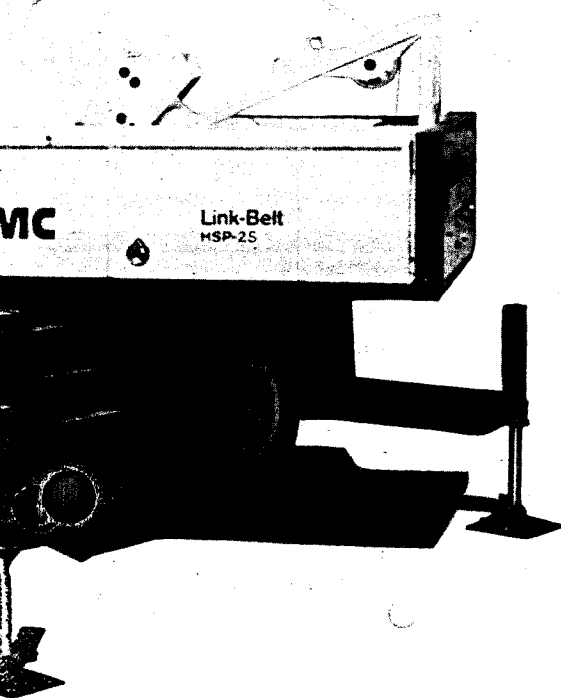

Outrigger controls

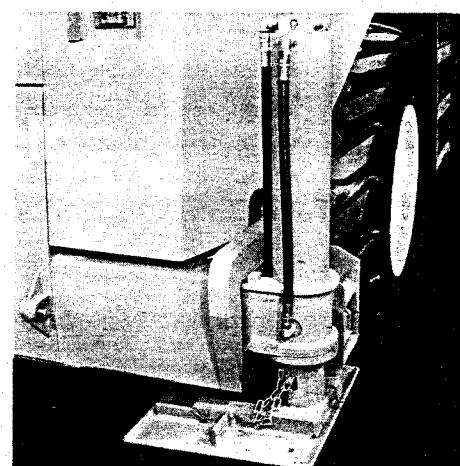

Float in stored position

The HSP-25 maximum boom/jib tip height is 121' (36.88 m)

Convenient storage of fly/jib in travel position

GENERAL INFORMATION ONLY

The HSP-25 lattice fly or jib options are conveniently **stored** on the side of boom in the travel position. A minimal amount of time is required to assemble the boom extensions into a working position. The HSP-25 offers exceptional **boom/fly/jib tip heights**, reach, and lifting capacity.

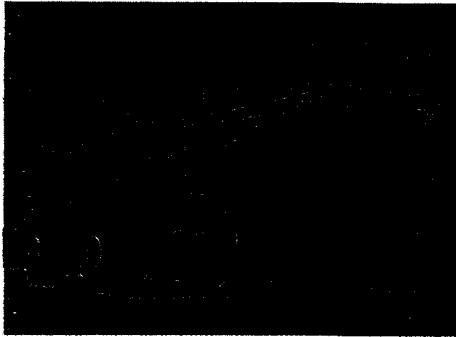

Fly In stored position

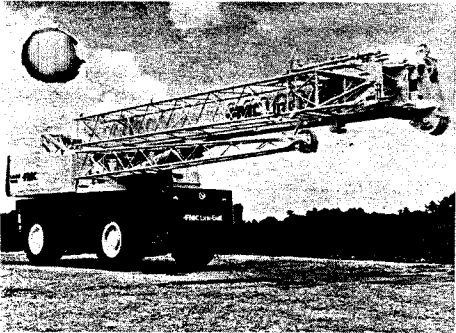

Jib in stored position

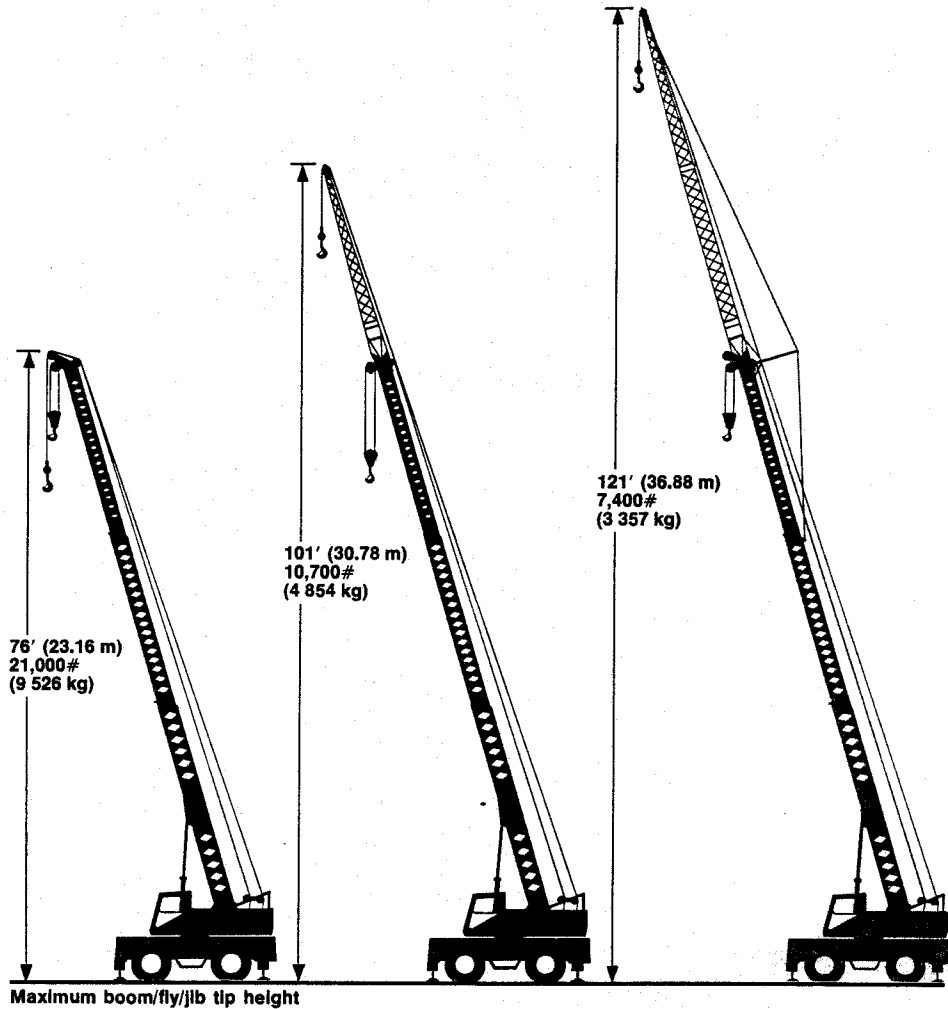

The HSP-25 features:

Carrier

- FMC designed and manufactured
Benefit: *Dependability and performance*
- Flat deck carrier
Benefit: *Added stability and unobstructed vision*
- Steering wheel coordinated steering mode
Benefit: *Added safety, maneuverability, and convenience*

Upperstructure

- Low profile frame
Benefit: *Lower center of gravity*
- Large 2-speed hoist drums
Benefit: *Decrease cycle times*
- Luxurious operator's cab
Benefit: *Increased operator efficiency*

Attachment

- FMC exclusive boom design
Benefit: *Dependable and reliable*
- Swing around fly and jib section
Benefit: *Easily assembled, exceptional capacities*
- 121' (36.88 m) boom/jib tip height
Benefit: *Gives extra added working range capability*

We are constantly improving our products and therefore reserve the right to change designs and specifications.

FMC Corporation Crane and Excavator Division World Headquarters Cedar Rapids Iowa 52406
Plants in: Cedar Rapids Iowa (2) • Lexington & Bowling Green Kentucky • Ontario Canada • Milan Italy • Queretaro Mexico & Nagoya Japa (under license)