

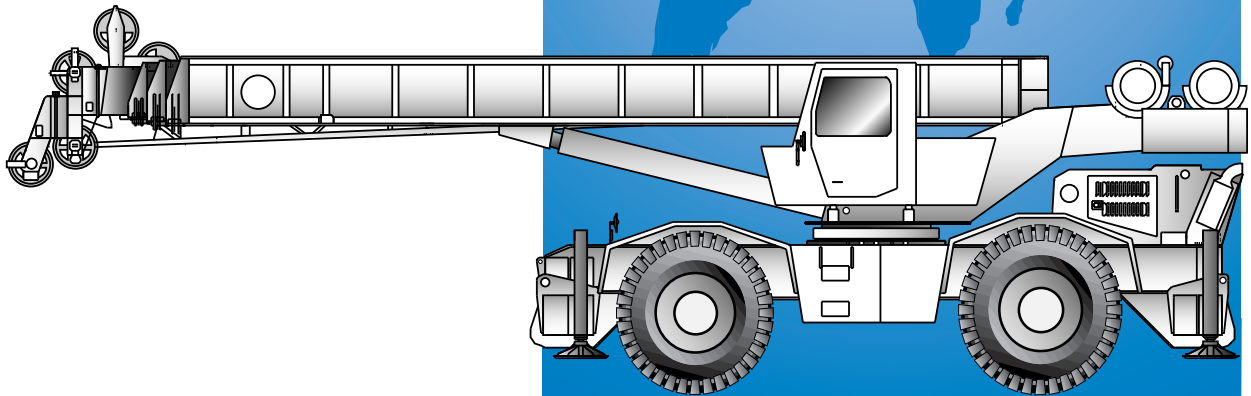

**GROVE<sup>®</sup>**  
**CRANE**

A GROVE WORLDWIDE COMPANY

# RT750



**Rough Terrain Hydraulic Crane**

# Dimensions

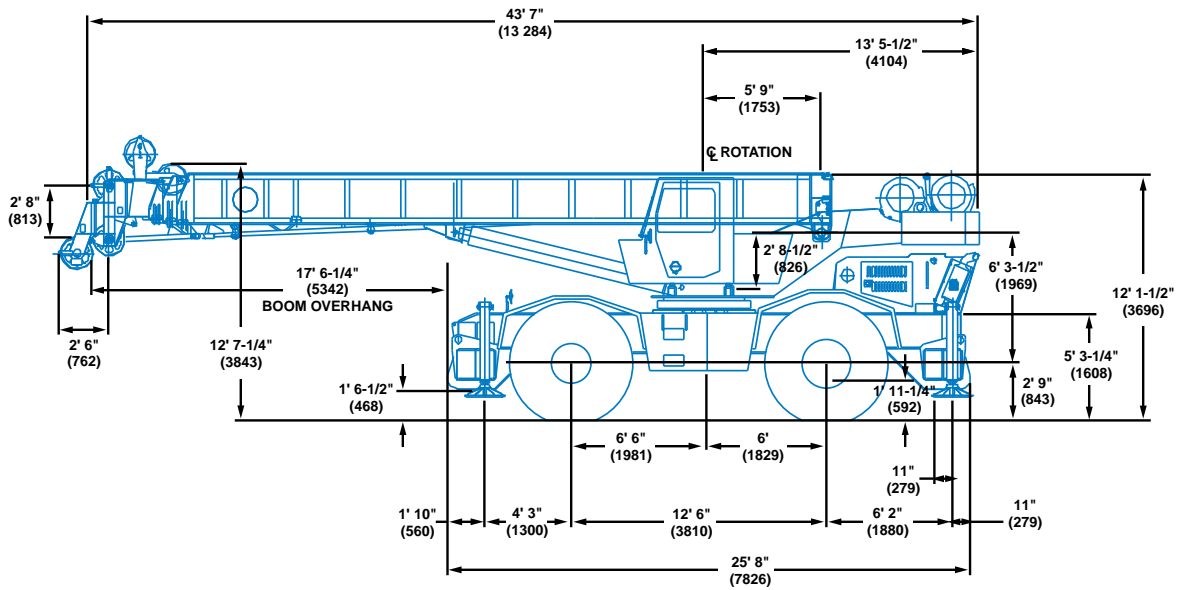
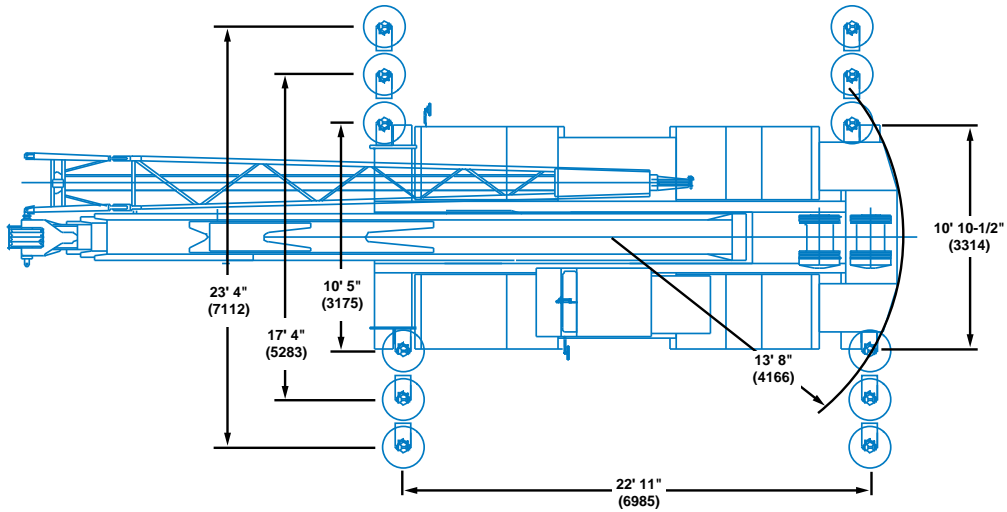

Note: ( ) Reference dimensions in mm

# Working Range



35 - 110 ft.  
(10.6 - 33.5 m)

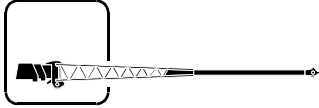

32 - 44 - 56 ft.  
(9.8 - 13.4 - 17.1 m)

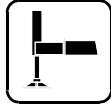

360°

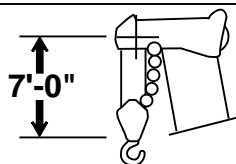
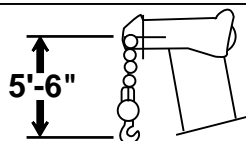
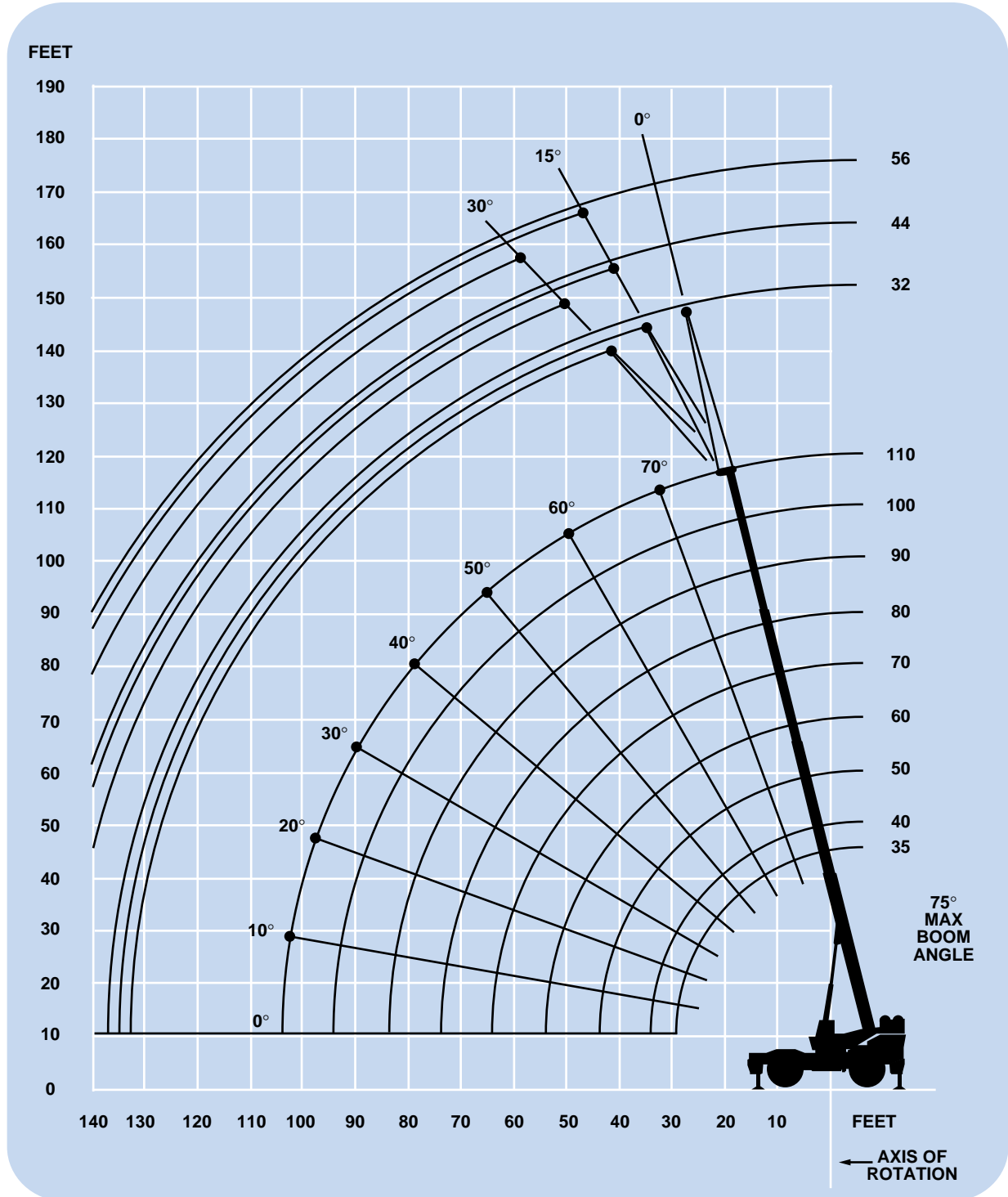

**DIMENSIONS ARE FOR LARGEST GROVE FURNISHED HOOK BLOCK AND HEADACHE BALL, WITH ANTI-TWO BLOCK ACTIVATED.**

# Superstructure specifications

## Boom

35 ft. - 110 ft. (10.6 m - 33.5 m) four-section full power boom.  
Maximum tip height: 117 ft. (35.6 m).

## Lattice Extension

32 ft. (9.8 m) lattice swingaway extension. Offsettable at 0°, 15° or 30°. Stows alongside base boom section.  
Maximum tip height: 147 ft. (44.8 m).

## \*Optional Telescoping Lattice Extension

32 ft. to 44 ft. or 56 ft. (9.8 m to 13.4 m or 17.1 m) telescoping lattice swingaway boom extension offsettable at 0°, 15° or 30°. Stows alongside base boom section.  
Maximum tip height: 170 ft. (51.8 m).

## Boom Nose

Four steel sheaves mounted on heavy duty tapered roller bearings with removable pin-type rope guards. Quick reeve type boom nose.  
\*Optional auxiliary boom nose.

## Boom Elevation

Dual double acting hydraulic cylinders with integral holding valves provide elevation from -4° to 75°.

## Load Moment & Anti-Two Block System

Standard load moment and anti-two block system with audio-visual warning and control lever lock-out. These systems provide electronic display of boom length, boom angle, radius, tip height, relative load moment, maximum permissible load and load indication and warning of impending two-block condition.

## Cab

Full vision, all steel fabricated with acoustical lining and tinted safety glass throughout. Complete driving controls and engine instrumentation. Dash mounted control levers for all craning functions. Other standard features include: hinged skylight, sliding left side door and sliding right side window, electric windshield wash-wipe, propane heater, circulating air fan, fire extinguisher, seat belt and two front mounted worklights.

## Swing

Ball bearing swing circle with 360° continuous rotation. Planetary glide swing with foot applied multi-disc brake. Spring applied, hydraulically released parking brake, plunger type one position and 360° mechanical house lock, operated from cab.  
Maximum speed: 2.6 RPM.

## Counterweight

Integral with turntable mast.  
With main hoist only: 12,000 lbs. (5443 kg)  
With main & aux.: 10,350 lbs. (4695 kg)

## Hydraulic System

4 main pumps with a combined capacity of 146 G.P.M. (553 LPM).  
Maximum operating pressure: 2,500 PSI (172.4 bar).

Four individual valve banks.

Return line type filter with full flow by-pass protection and service indicator. Replaceable cartridge with micron filtration rating of 15/30/38.

154 gallon (583 L) reservoir.

Remote-mounted oil cooler with thermostatically controlled electric motor driven fan/air to oil.

System pressure test ports with quick release type fittings for each circuit.

## HOIST SPECIFICATIONS Main and Auxiliary Hoist

Planetary reduction with automatic spring applied multi-disc brake. Electronic hoist drum rotation indicator, hoist drum cable followers and wire rope.

	High	Low
Maximum Single Line Pull:	9,280 lbs. (4209 kg)	18,560 lbs. (8419 kg)
Maximum Single Line Speed:	532 FPM (162 m/min)	266 FPM (81 m/min)
Maximum Permissible Line Pull:		12,920 lbs. (5860 kg)
Rope Diameter:		3/4" (19 mm)
Rope Length:		500 ft. (152 m)
Maximum Rope Stowage: (3/4" 18 x 19 Class)		690 ft. (210 m)

*\*Denotes optional equipment*

# Carrier specifications

## Chassis

Box section frame fabricated from high strength, low alloy steel. Integral outrigger housings and front/rear towing and tie down lugs.

## Outrigger System

Four hydraulic telescoping, single stage, double box beam outriggers with inverted jacks and integral holding valves. Three position setting, all steel fabricated, quick release type outrigger floats, 24 in. (610 mm) diameter.  
Maximum outrigger pad load: 73,344 lbs. (33 269 kg).

## Outrigger Controls

Controls and crane level indicator located in cab.

## Engine

Cummins 6BTA 5.9 L diesel, six cylinders, turbocharged and after cooled, 200 bhp (149 kW) (Gross) @ 2,500 RPM.  
Maximum torque: 600 ft. lbs. (814 Nm) @ 1,500 RPM.

## \*Optional Engine

Cat 3116TA diesel, six cylinders, turbocharged and after cooled, 190 bhp (142 kW) (Gross) @ 2,600 RPM.  
Maximum torque: 490 ft. lbs. (664 Nm) @ 1,650 RPM.

## Fuel Tank Capacity

60 gallons (227 L).

## Electrical System

Two 12 V - maintenance free batteries. 12 V starting.

## Drive

4 x 4

## Steering

Full independent power steering:

Front: Full hydraulic steering wheel controlled.

Rear: Full hydraulic hand lever controlled.

Provides infinite variations of 4 main steering modes: front only, rear only, crab and coordinated. Rear steer indicating gauge.

## Transmission

Full powershift with 6 forward and 6 reverse speeds.  
Rear axle disconnect for 4 x 2 travel.

## Axles

Front: Drive/steer with differential and planetary reduction hubs rigid mounted to chassis.

Rear: Drive/steer with differential and planetary reduction hubs pivot mounted to chassis.

\*Optional: Cross axle differential lock front and rear.

## Oscillation Lockouts

Automatic full hydraulic lockouts on rear axle permit oscillation only with boom centered over the front.  
\*Optional oscillation lockout override control.

## Tires

29.5 x 25-28 PR earthmover type, bias tubeless.

## \*Optional Tires

29.5R25 radial.

## Brakes

Full air split circuit operating on all wheels. Spring-applied, air released parking brake operating on front and rear axles.

## Lights

Full lighting package including turn indicators, head and tail lights, brake and hazard warning lights.

## Maximum Speed

20.3 mph (32.7 kph).

## Gradeability (Theoretical)

128% (Based on 87,500 lbs. [39 690 kg] GVW) 29.5 x 25 tires, pumps disengaged, 110 ft. (33.5 m) boom, plus 32 ft. (9.8 m) swingaway.

## Miscellaneous Standard Equipment

Full width steel fenders, dual rear view mirrors, hook block tiedown, electronic back-up alarm, front storage well, light package, air dryer, 360° mechanical house lock, tachometer/hourmeter, low oil pressure/high water temperature a/v warning system.

## \*Optional Equipment

- \* 360° flashing light
- \* Cab spotlight
- \* Engine block heater
- \* Manual skylight wiper
- \* Hookblocks (quick reeve type)
- \* Headache ball
- \* Tow winch (15,000 lbs. [6804 kg] single line pull
- \* Tire inflation kit
- \* Tool kit
- \* Pintle hooks - front and rear
- \* Diesel heater/defroster
- \* Hydraulic oil cab heater
- \* Air conditioner
- \* LMI light bar

*\*Denotes optional equipment*



35 - 110 ft.  
(10.6 - 33.5 m)



12,000 lbs.  
(5443 kg)



100%



360°



Pounds

(Feet)	35	40	50	*60	70	80	90	100	110
10	100,000 (63.5)	80,400 (66.5)	74,400 (71.5)	44,600 (75.5)					
12	88,050 (60)	79,050 (63.5)	70,900 (69)	44,600 (74)	@ 35,600 (75.5)				
15	74,500 (54)	67,450 (59)	63,350 (65.5)	44,600 (71)	35,600 (74)	@ 33,000 (75.5)			
20	54,700 (43)	53,850 (50.5)	50,900 (59)	44,600 (66)	35,600 (70)	33,000 (72.5)	25,500 (75)	@ 23,300 (75.5)	
25	41,450 (29)	41,150 (40.5)	40,700 (52.5)	40,350 (60.5)	35,550 (65.5)	33,000 (69)	25,500 (71.5)	23,300 (74)	@ 18,500 (75.5)
30		32,450 (28)	32,050 (45)	31,750 (55)	30,550 (61)	28,950 (65)	25,500 (68)	23,300 (71)	18,500 (73)
35			25,950 (36.5)	25,650 (48.5)	26,500 (56.5)	24,900 (61)	23,000 (64.5)	21,200 (68)	18,500 (70.5)
40			21,400 (25)	21,150 (41.5)	22,000 (51.5)	21,750 (57)	20,000 (61)	18,450 (65)	18,000 (67.5)
45				17,600 (33.5)	18,500 (46)	19,100 (53)	17,600 (57.5)	16,300 (61.5)	15,750 (65)
50				14,600 (23)	15,250 (39.5)	15,700 (48)	15,650 (53.5)	14,400 (58)	13,950 (62)
55					12,650 (32.5)	13,100 (43)	13,550 (49.5)	12,850 (54.5)	12,450 (59)
60					10,500 (23)	11,000 (37.5)	11,450 (45)	11,550 (51)	11,150 (55.5)
65						9,350 (31)	9,780 (40.5)	10,200 (47)	10,050 (52.5)
70						7,870 (22)	8,370 (35)	8,780 (43)	9,090 (49)
75							7,180 (28.5)	7,590 (38.5)	7,980 (45)
80							6,120 (20)	6,560 (33)	6,950 (41)
85								5,680 (27)	6,060 (37)
90								4,910 (19)	5,280 (32)
95									4,600 (26)
100									3,990 (18.5)

Minimum boom angle (deg.) for indicated length

0

Maximum boom length (ft.) at 0 deg. boom angle (no load)

110

Note: ( ) Boom angles are in degrees.

@ This capacity is based upon maximum boom angle.

\* 60 ft. boom length is with inner-mid extended and outer-mid & fly retracted.

Boom Angle	35	40	50	*60	70	80	90	100	110
0°	20,750 (29.2)	16,750 (34.3)	11,300 (44.3)	7,720 (54.1)	5,960 (64.3)	4,680 (74.3)	3,680 (84.3)	2,880 (94.3)	2,240 (104.1)

NOTE: ( ) Reference radii are in feet.

A6-829-015221



35 - 110 ft.  
(10.6 - 33.5 m)



12,000 lbs.  
(5443 kg)



50%  
17' 4" Spread



360°



Pounds

(Feet)	35	40	50	*60	70	80	90	100	110
10	100,000 (63.5)	80,400 (66.5)	74,400 (71.5)	44,600 (75.5)					
12	88,050 (60)	79,050 (63.5)	70,900 (69)	44,600 (74)	@ 35,600 (75.5)				
15	74,500 (54)	67,450 (59)	63,350 (65.5)	44,600 (71)	35,600 (74)	@ 33,000 (75.5)			
20	52,700 (43)	52,350 (50.5)	50,900 (59)	44,600 (66)	35,600 (70)	33,000 (72.5)	25,500 (75)	@ 23,300 (75.5)	
25	34,400 (29)	34,050 (40.5)	33,300 (52.5)	32,600 (60.5)	33,550 (65.5)	33,000 (69)	25,500 (71.5)	23,300 (74)	@ 18,500 (75.5)
30		24,300 (28)	23,550 (45)	22,800 (55)	23,650 (61)	24,500 (65)	25,300 (68)	23,300 (71)	18,500 (73)
35			17,500 (36.5)	16,750 (48.5)	17,550 (56.5)	18,300 (61)	19,000 (64.5)	19,750 (68)	18,500 (70.5)
40			13,400 (25)	12,650 (41.5)	13,350 (51.5)	14,050 (57)	14,750 (61)	15,450 (65)	16,100 (67.5)
45				9,660 (33.5)	10,350 (46)	11,000 (53)	11,650 (57.5)	12,300 (61.5)	12,950 (65)
50				7,400 (23)	8,060 (39.5)	8,690 (48)	9,320 (53.5)	9,940 (58)	10,550 (62)
55					6,260 (32.5)	6,880 (43)	7,480 (49.5)	8,080 (54.5)	8,670 (59)
60					4,810 (23)	5,410 (37.5)	6,000 (45)	6,580 (51)	7,150 (55.5)
65						4,210 (31)	4,780 (40.5)	5,350 (47)	5,910 (52.5)
70						3,200 (22)	3,760 (35)	4,320 (43)	4,860 (49)
75							2,900 (28.5)	3,450 (38.5)	3,980 (45)
80							2,150 (20)	2,690 (33)	3,220 (41)
85								2,040 (27)	2,560 (37)
90								1,460 (19)	1,980 (32)
95									1,460 (26)
100									1,010 (18.5)
0.1A (lbs.)	765	805	870	915	840	790	750	715	690

Minimum boom angle (deg.) for indicated length

10

Maximum boom length (ft.) at 0 deg. boom angle (no load)

100

Note: ( ) Boom angles are in degrees.

@ This capacity is based upon maximum boom angle.

\* 60 ft. boom length is with inner-mid extended and outer-mid & fly retracted.

Boom  
Angle

	35	40	50	60	70	80	90	100
0°	20,750 (29.2)	16,750 (34.3)	10,800 (44.3)	5,910 (54.1)	3,780 (64.3)	2,460 (74.3)	1,600 (84.3)	1,030 (94.3)

Note: ( ) Reference radii in feet.

A6-829-015222



35 - 110 ft.  
(10.6 - 33.5 m)



12,000 lbs.  
(5443 kg)



0%  
10' 5" Spread



360°



Pounds

(Feet)	35	40	50	*60	70	80	90	100	110
10	79,850 (63.5)	75,500 (66.5)	68,400 (71.5)	44,600 (75.5)					
12	60,500 (60)	57,550 (63.5)	52,750 (69)	44,600 (74)	@ 35,600 (75.5)				
15	41,750 (54)	41,550 (59)	38,400 (65.5)	35,800 (71)	35,350 (74)	@ 33,000 (75.5)			
20	25,250 (43)	25,000 (50.5)	24,450 (59)	23,550 (66)	23,750 (70)	23,700 (72.5)	23,500 (75)	@ 23,300 (75.5)	
25	17,100 (29)	16,800 (40.5)	16,200 (52.5)	15,600 (60.5)	16,400 (65.5)	17,150 (69)	17,250 (71.5)	17,200 (74)	@ 17,100 (75.5)
30		11,900 (28)	11,250 (45)	10,600 (55)	11,350 (61)	12,050 (65)	12,750 (68)	13,200 (71)	13,200 (73)
35			7,990 (36.5)	7,330 (48.5)	8,020 (56.5)	8,680 (61)	9,340 (64.5)	9,980 (68)	10,400 (70.5)
40			5,660 (25)	4,970 (41.5)	5,630 (51.5)	6,260 (57)	6,880 (61)	7,500 (65)	8,100 (67.5)
45				3,200 (33.5)	3,840 (46)	4,450 (53)	5,050 (57.5)	5,640 (61.5)	6,220 (65)
50				1,830 (23)	2,450 (39.5)	3,040 (48)	3,620 (53.5)	4,200 (58)	4,760 (62)
55					1,340 (32.5)	1,910 (43)	2,480 (49.5)	3,040 (54.5)	3,590 (59)
60							1,550 (45)	2,100 (51)	2,630 (55.5)
65								1,310 (47)	1,840 (52.5)
70									1,160 (49)
0.1A (lbs.)	765	805	870	915	840	790	750	715	690
Minimum boom angle (deg.) for indicated length				5	26	38	42	45	48
Maximum boom length (ft.) at 0 deg. boom angle (no load)							50		

Note: ( ) Boom angles are in degrees.

@ This capacity is based upon maximum boom angle.

\* 60 ft. boom length is with inner-mid extended and outer-mid & fly retracted.

Boom  
Angle

	35	40	50
0°	12,900 (29.2)	9,100 (34.3)	4,140 (44.3)

Note: ( ) Reference radii in feet.

A6-829-015223





35 - 110 ft.  
(10.6 - 33.5 m)

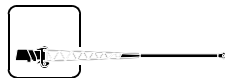

32 - 56 ft.  
(9.8 - 17.1 m)



12,000 lbs.  
(5443 kg)



100%



360°



Pounds

(Feet)	**32 ft. LENGTH			44 ft. LENGTH			56 ft. LENGTH		
	0° OFFSET	15° OFFSET	30° OFFSET	0° OFFSET	15° OFFSET	30° OFFSET	0° OFFSET	15° OFFSET	30° OFFSET
35	@10,400 (75.5)								
40	9,500 (73)	@7,900 (75.5)		@8,800 (75.5)			@7,300 (75.5)		
45	8,600 (71)	7,200 (74.5)	@5,800 (75.5)	7,700 (73.5)	@5,800 (75.5)		6,400 (75)		
50	8,100 (68.5)	6,400 (72.5)	5,150 (74)	7,100 (71.5)	4,800 (74.5)		5,900 (73)	@4,000 (75.5)	
55	7,200 (66.5)	6,080 (70)	4,940 (71.5)	6,500 (69.5)	4,450 (72.5)	@3,750 (75.5)	5,320 (71.5)	3,750 (75)	
60	6,610 (64)	5,800 (68)	4,750 (69)	6,010 (67.5)	4,200 (70.5)	3,300 (74)	4,800 (69.5)	3,500 (74)	@2,600 (75.5)
65	5,950 (62)	5,340 (66)	4,550 (67)	5,370 (65.5)	3,960 (68.5)	3,120 (72)	4,300 (67.5)	3,250 (72)	2,470 (75)
70	5,500 (59.5)	4,970 (63)	4,400 (64.5)	5,000 (63)	3,800 (66.5)	3,050 (70)	4,000 (65.5)	3,000 (70)	2,370 (73.5)
75	4,980 (57)	4,530 (61)	4,240 (62)	4,520 (61)	3,600 (64)	2,930 (67.5)	3,680 (64)	2,800 (68)	2,240 (71.5)
80	4,630 (54.5)	4,250 (58.5)	3,980 (59.5)	4,210 (59)	3,450 (62)	2,850 (65.5)	3,500 (62)	2,670 (66)	2,130 (69.5)
85	4,230 (52)	3,900 (56)	3,690 (57)	3,830 (56.5)	3,300 (60)	2,720 (63)	3,300 (60)	2,500 (64)	2,050 (67)
90	3,940 (49.5)	3,670 (53)	3,470 (54)	3,580 (54.5)	3,200 (57.5)	2,670 (60.5)	3,200 (57.5)	2,400 (62)	2,000 (65)
95	3,620 (46.5)	3,380 (50)	3,200 (51)	3,290 (52)	3,040 (55)	2,600 (58)	3,020 (55.5)	2,330 (59.5)	1,930 (63)
100	3,390 (44)	3,180 (47.5)	3,040 (48)	3,070 (49.5)	2,840 (52.5)	2,580 (55.5)	2,850 (53.5)	2,250 (57.5)	1,890 (60.5)
105	3,130 (40.5)	2,950 (44)	2,820 (45)	2,830 (47)	2,650 (50)	2,500 (53)	2,620 (51)	2,150 (55)	1,830 (58)
110	2,920 (37.5)	2,780 (41)	2,690 (41.5)	2,650 (44)	2,480 (47)	2,370 (50)	2,460 (48.5)	2,050 (53)	1,800 (56)
115	2,570 (34)	2,590 (37)	2,510 (37.5)	2,440 (41)	2,300 (44)	2,200 (47)	2,280 (46)	1,970 (50)	1,750 (53)
120	2,140 (30)	2,250 (33)	2,360 (33)	2,290 (38)	2,170 (41)	2,090 (43.5)	2,130 (43.5)	1,920 (47.5)	1,720 (50.5)
125	1,750 (25)	1,830 (28.5)		2,100 (35)	2,000 (37.5)	1,940 (40)	1,970 (41)	1,830 (45)	1,700 (47.5)
130	1,390 (19.5)	1,440 (22.5)		1,890 (31)	1,910 (34)	1,860 (36)	1,840 (38)	1,740 (42)	1,680 (44.5)
135				1,540 (27)	1,710 (29.5)		1,700 (35)	1,620 (39)	1,570 (41)
140				1,230 (22)	1,410 (24.5)		1,600 (31.5)	1,530 (35.5)	1,490 (37)
145							1,460 (28)	1,430 (31.5)	1,380 (33)
150							1,170 (23.5)	1,350 (27)	
Minimum boom angle (deg.) for indicated length (no load)							15	25	30
Maximum boom length (ft.) at 0 degree boom angle (no load)							100		

NOTE: ( ) Boom angles are in degrees.

@ This capacity is based upon maximum boom angle.

\*\*32 ft. tele. length is also applicable to 32 ft. fixed length, however, the LMI code will change for the 0°, 15° and 30° offsets respectively.

A6-829-015224

THIS CHART IS ONLY A GUIDE AND SHOULD NOT BE USED TO OPERATE THE CRANE. The individual crane's load chart, operating instructions and other instructional plates must be read and understood prior to operating the crane.



35 - 110 ft.  
(10.6 - 33.5 m)



32 - 56 ft.  
(9.8 - 17.1 m)



12,000 lbs.  
(5443 kg)



50%  
17' 4" Spread



360°



Pounds

(Feet)	**32 ft. LENGTH			44 ft. LENGTH			56 ft. LENGTH		
	0° OFFSET	15° OFFSET	30° OFFSET	0° OFFSET	15° OFFSET	30° OFFSET	0° OFFSET	15° OFFSET	30° OFFSET
35	@10,400 (75.5)								
40	9,500 (73)	@7,900 (75.5)		@8,800 (75.5)			@7,300 (75.5)		
45	8,600 (71)	7,200 (74.5)	@5,800 (75.5)	7,700 (73.5)	@5,800 (75.5)		6,400 (75)		
50	8,100 (68.5)	6,400 (72.5)	5,150 (74)	7,100 (71.5)	4,800 (74.5)		5,900 (73)	@4,000 (75.5)	
55	7,200 (66.5)	6,080 (70)	4,940 (71.5)	6,500 (69.5)	4,450 (72.5)	@3,750 (75.5)	5,320 (71.5)	3,750 (75)	
60	6,610 (64)	5,800 (68)	4,750 (69)	6,010 (67.5)	4,200 (70.5)	3,300 (74)	4,800 (69.5)	3,500 (74)	@2,600 (75.5)
65	5,950 (62)	5,340 (66)	4,550 (67)	5,370 (65.5)	3,960 (68.5)	3,120 (72)	4,300 (67.5)	3,250 (72)	2,470 (75)
70	5,410 (59.5)	4,970 (63)	4,400 (64.5)	5,000 (63)	3,800 (66.5)	3,050 (70)	4,000 (65.5)	3,000 (70)	2,370 (73.5)
75	4,440 (57)	4,530 (61)	4,240 (62)	4,520 (61)	3,600 (64)	2,930 (67.5)	3,680 (64)	2,800 (68)	2,240 (71.5)
80	3,610 (54.5)	4,020 (58.5)	3,980 (59.5)	4,150 (59)	3,450 (62)	2,850 (65.5)	3,500 (62)	2,670 (66)	2,130 (69.5)
85	2,890 (52)	3,250 (56)	3,620 (57)	3,440 (56.5)	3,300 (60)	2,720 (63)	3,300 (60)	2,500 (64)	2,050 (67)
90	2,260 (49.5)	2,580 (53)	2,900 (54)	2,820 (54.5)	3,200 (57.5)	2,670 (60.5)	2,890 (57.5)	2,400 (62)	2,000 (65)
95	1,700 (46.5)	1,980 (50)	2,270 (51)	2,270 (52)	2,750 (55)	2,600 (58)	2,390 (55.5)	2,330 (59.5)	1,930 (63)
100	1,200 (44)	1,450 (47.5)	1,700 (48)	1,780 (49.5)	2,200 (52.5)	2,580 (55.5)	1,940 (53.5)	2,250 (57.5)	1,890 (60.5)
105			1,200 (45)	1,340 (47)	1,700 (50)	2,070 (53)	1,540 (51)	2,150 (55)	1,830 (58)
110					1,250 (47)	1,570 (50)	1,180 (48.5)	1,740 (53)	1,800 (56)
115						1,120 (47)		1,340 (50)	1,750 (53)
120									1,410 (50.5)
125									1,010 (47.5)
0.1A (lbs.)	745	735	715	695	685	660	650	640	615
Minimum boom angle (deg.) for indicated length (no load)	35	35	35	40	40	40	40	46	47
Maximum boom length (ft.) at 0 degree boom angle (no load)		80			80			80	

NOTE: ( ) Boom angles are in degrees.

@This capacity is based upon maximum boom angle.

\*\*32 ft. tele. length is also applicable to 32 ft. fixed length, however, the LMI code will change for the 0°, 15° and 30° offsets respectively.

A6-829-015225



35 - 110 ft.  
(10.6 - 33.5 m)



12,000 lbs.  
(5443 kg)



Stationary  
29.5 x 25 (28 Ply) Tires



360°



(Feet)



Pounds

(Feet)	35	40	50	*60	70
10	47,400 (63.5)	38,900 (66.5)	30,550 (71.5)		
12	37,650 (60)	37,650 (63.5)	30,550 (69)	22,250 (74)	
15	26,300 (54)	26,300 (59)	26,300 (65.5)	17,300 (71)	17,300 (74)
20	15,800 (43)	15,800 (50.5)	15,800 (59)	15,800 (66)	15,800 (70)
25	10,350 (29)	10,350 (40.5)	10,350 (52.5)	10,350 (60.5)	10,350 (65.5)
30		7,020 (28)	7,020 (45)	7,020 (55)	7,020 (61)
35			4,750 (36.5)	4,750 (48.5)	4,750 (56.5)
40			3,120 (25)	3,120 (41.5)	3,120 (51.5)
45				1,880 (33.5)	1,880 (46)

NOTE: ( ) Boom angles are in degrees.

\*60 ft. boom length is with inner-mid extended and outer-mid & fly retracted.

Boom Angle	35	40	50
0°	8,560 (29.2)	5,690 (34.3)	2,300 (44.3)

NOTE: ( ) Reference radii are in feet.

A6-829-015218A



35 - 110 ft.  
(10.6 - 33.5 m)



12,000 lbs.  
(5443 kg)



Stationary  
29.5 x 25 (28 Ply) Tires



Defined Arc  
Over Front



(Feet)



Pounds

(Feet)	35	40	50	*60	70
10	47,400 (63.5)	38,900 (66.5)	30,550 (71.5)		
12	38,900 (60)	38,900 (63.5)	30,550 (69)	22,250 (74)	
15	30,550 (54)	30,550 (59)	26,300 (65.5)	17,300 (71)	17,300 (74)
20	26,050 (43)	26,050 (50.5)	22,250 (59)	17,300 (66)	17,300 (70)
25	21,150 (29)	21,150 (40.5)	21,150 (52.5)	17,300 (60.5)	17,300 (65.5)
30		15,300 (28)	15,300 (45)	15,300 (55)	15,300 (61)
35			11,350 (36.5)	11,350 (48.5)	11,350 (56.5)
40			8,590 (25)	8,590 (41.5)	8,590 (51.5)
45				6,490 (33.5)	6,490 (46)
50				4,860 (23)	4,860 (39.5)
55					3,630 (32.5)
60					2,610 (23)

NOTE: ( ) Boom angles are in degrees.

\*60 ft. boom length is with inner-mid extended and outer-mid & fly retracted.

Boom Angle	35	40	50	60	70
0°	16,900 (29.2)	12,400 (34.3)	6,850 (44.3)	3,780 (54.1)	1,890 (64.3)

NOTE: ( ) Reference radii are in feet.

A6-829-015219A



35 - 110 ft.  
(10.6 - 33.5 m)



12,000 lbs.  
(5443 kg)



Pick & Carry  
Up to 2.5 MPH  
29.5 x 25 (28 PR) Tires



Over Front



(Feet)	35	40	50	*60	70
10	50,650 (63.5)	47,450 (66.5)	32,700 (71.5)		
12	47,400 (60)	47,400 (63.5)	32,700 (69)	32,700 (74)	
15	41,300 (54)	41,300 (59)	32,700 (65.5)	32,700 (71)	24,000 (74)
20	31,000 (43)	31,000 (50.5)	31,000 (59)	31,000 (66)	24,000 (70)
25	21,150 (29)	21,150 (40.5)	21,150 (52.5)	21,150 (60.5)	21,150 (65.5)
30		15,300 (28)	15,300 (45)	15,300 (55)	15,300 (61)
35			11,350 (36.5)	11,350 (48.5)	11,350 (56.5)
40			8,590 (25)	8,590 (41.5)	8,590 (51.5)
45				6,490 (33.5)	6,490 (46)
50				4,860 (23)	4,860 (39.5)
55					3,630 (32.5)
60					2,610 (23)

NOTE: ( ) Boom angles are in degrees.

\*60 ft. boom length is with inner-mid extended and outer-mid & fly retracted.

Boom Angle	35	40	50	*60	70
0°	16,900 (29.2)	12,400 (34.3)	6,850 (44.3)	3,780 (54.1)	1,890 (64.3)

NOTE: ( ) Reference radii are in feet.

A6-829-015220

## *Weight Reductions for Load Handling Devices*

<b>32 ft. Fixed Extension (Stowed on Boom Base Section)</b>	<b>521 lbs.</b>
<b>32 ft. - 56 ft. Tele. Extension (Stowed on Boom Base Section)</b>	<b>718 lbs.</b>
<b>32 ft. Fixed Extension (Erected)</b>	<b>5,851 lbs.</b>
<b>32 ft. Tele. Extension (Erected)</b>	<b>8,636 lbs.</b>
<b>44 ft. Tele. Extension (Erected)</b>	<b>10,307 lbs.</b>
<b>56 ft. Tele. Extension (Erected)</b>	<b>12,066 lbs.</b>

<b>AUXILIARY BOOM HEAD</b>	<b>220 lbs.</b>
<b>HOOKBLOCKS and HEADACHE BALLS:</b>	
<b>50 Ton, 4 Sheave</b>	<b>1,469 lbs. +</b>
<b>45 Ton, 3 Sheave w/Cheekplates</b>	<b>977 lbs. +</b>
<b>45 Ton, 3 Sheave w/o Cheekplates</b>	<b>830 lbs. +</b>
<b>15 Ton, 1 Sheave</b>	<b>420 lbs. +</b>
<b>5 Ton Headache Ball</b>	<b>172 lbs. +</b>
<b>7 1/2 Ton Headache Ball</b>	<b>338 lbs. +</b>
<b>10 Ton Headache Ball</b>	<b>560 lbs. +</b>
<b>+Refer to rating plate for actual weight.</b>	

**NOTES:**

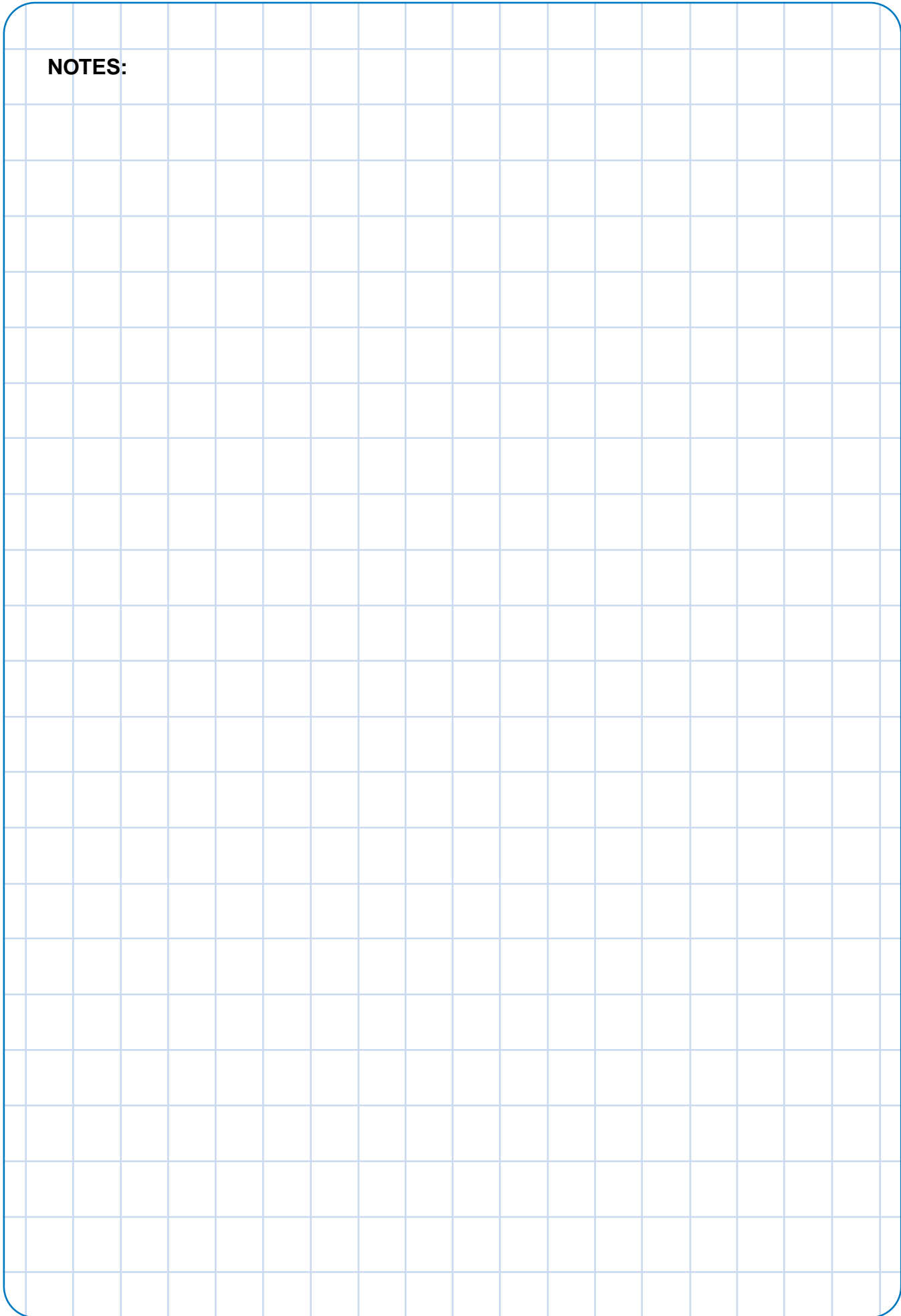

**NOTES:**

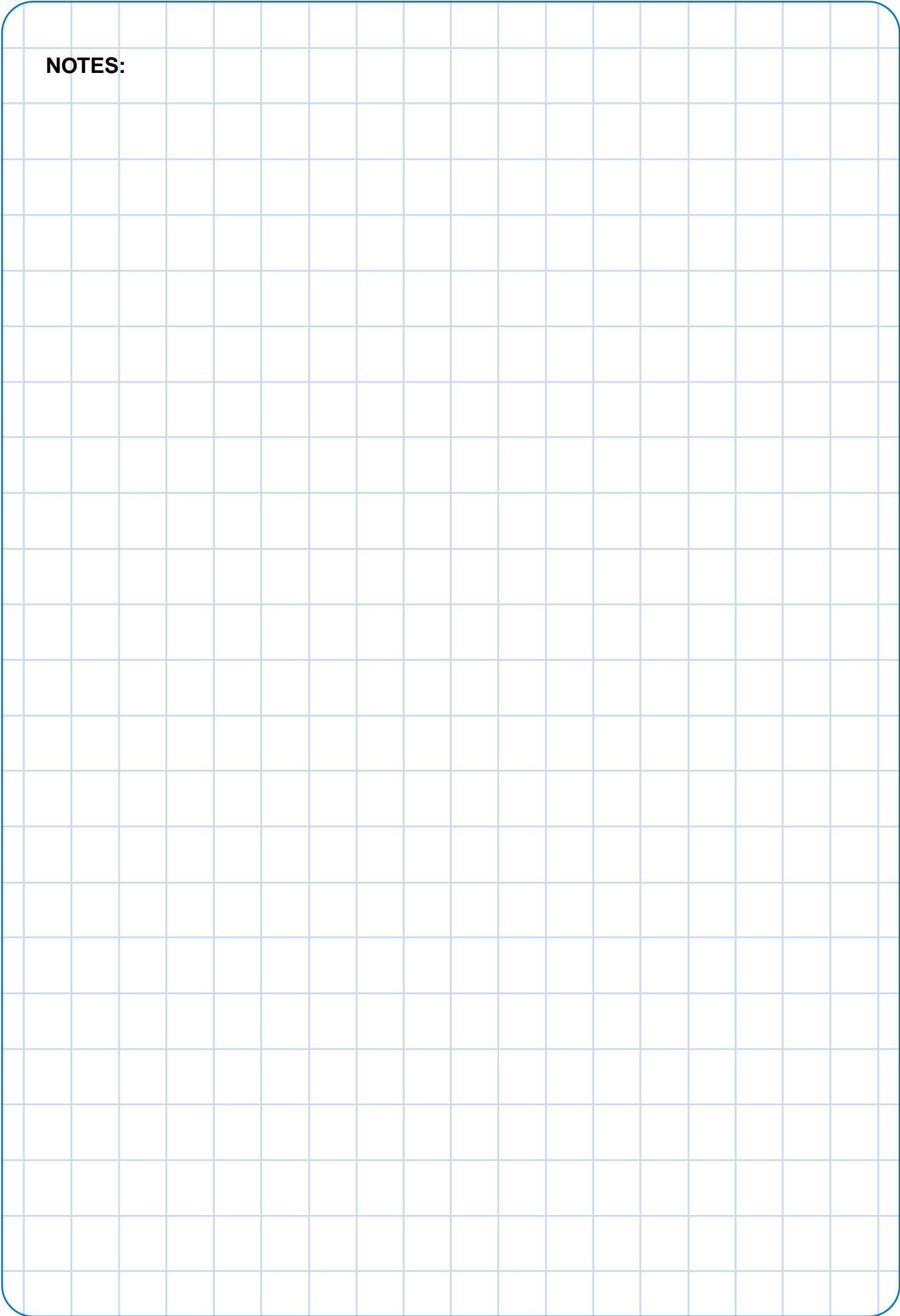



# Rated Lifting Capacities





































## IMPORTANT NOTES:

### WARNING: THIS CHART IS ONLY A GUIDE.

The notes below are for illustration only and should not be relied upon to operate the crane. The individual crane's load chart, operating instructions and other instruction plates must be read and understood prior to operating the crane.

1. All rated loads have been tested to and meet minimum requirements of SAEJ1063 NOV93 - Cantilevered Boom Crane Structures - Method of Test, perform to SAEJ765 OCT90 Crane Stability Test Code.
2. Capacities given do not include the weight of hook blocks, slings, auxiliary lifting equipment and load handling devices. Their weights MUST be added to the load to be lifted. When more than minimum required reeving is used, the additional rope weight shall be considered part of the load.
3. Capacities appearing above the bold line are based on structural strength. Tipping should never be relied upon as a capacity indication.
4. All capacities are for crane on firm, level surface. It may be necessary to have structural supports under the outrigger floats to spread the load to a larger bearing surface.
5. When either boom length or radius or both are between values listed, the smallest load shown at either the next larger radius or boom length shall be used.
6. For outrigger operation, ALL outriggers shall be properly extended with tires raised free of ground before raising the boom or lifting loads.

## Symbols Glossary

	Frame		Steering
	Outriggers		Transmission
	Outrigger Controls		Axles
	Engine		Brakes
	Fuel Tank Capacity		Tires
	Electrical System		Suspension
	Drive		Rotation
	Lights		Boom Elevation
	Cab		Swing
	Boom		Counterweight
	Fixed Swingaway		Oil
	Tele-Swingaway		Hydraulic System
	Jib		Hoist
	Boom Nose		Radius
	Boom Extension		Boom Length
	Speed		Hookblock
	Grade		Gear
	Lattice Extension		Luffing Jib

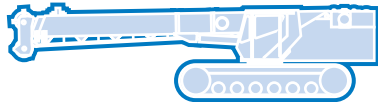
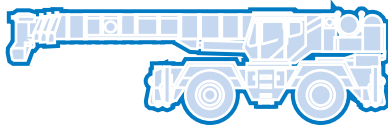
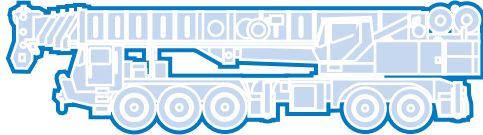
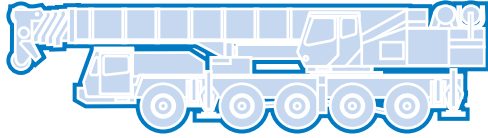

**Grove Worldwide – World Headquarters**

**Grove North America**  
1565 Buchanan Trail East  
P.O. Box 21  
Shady Grove, Pennsylvania 17256, U.S.A.  
Tel: [Int + 1] (717) 597-8121  
Fax: [Int + 1] (717) 597-4062  
Western Hemisphere, Asia/Pacific

**Grove Europe Limited\***

Sunderland SR4 6TT, England  
Tel: [Int + 44] 191 565-6281  
Fax: [Int + 44] 191 564-0442  
Europe, Africa, Middle East

**Grove Europe Limited\***

P.O. Box No. 268  
4A Kimber Road  
Abingdon, Oxfordshire, OX141SG  
Tel: [Int + 44] 1235 55-3184  
Fax: [Int + 44] 1235 55-3218

**Deutsche Grove GmbH**

**Sales and Service**  
Helmholtzstrasse 12, Postfach 5026  
D-40750 Langenfeld, Germany  
Tel: [Int + 49] (2173) 8909-0  
Fax: [Int + 49] (2173) 8909-30

**Wilhelmshaven Works**

Industriegelände West, Postfach 1853  
D-26358 Wilhelmshaven, Germany  
Tel: [Int + 49] (4421) 294-0  
Fax: [Int + 49] (4421) 294-301

**Grove France S.A.**

16, chaussée Jules-César, 95520 OSNY  
B.P. 203, 95523 CERGY PONTOISE CEDEX  
France  
Tel: [Int + 33] (1) 30313150  
Int: [Int + 33] (1) 30386085

\*Grove Europe Limited, Registered in England,  
Number 1845128, Registered office, Crown Works,  
Pallion, Sunderland, Tyne & Wear, England SR4 6TT

**Grove Asia/Pacific - Regional Office**

171 Chin Swee Road  
#06-01 San Centre  
Singapore 0316  
Tel: [Int + 65] 536-6112  
Fax: [Int + 65] 536-6119  
Asia/Pacific, Near East

**Grove China - Representative Office**

Beijing Hotel Room 6074  
No. 33 East Chang An Avenue  
Beijing, 100004, China  
Tel: [Int + 86] (10) 513-7766  
Fax: [Int + 86] (10) 513-7307

**Grove Product Support**

Western Hemisphere, Asia/Pacific  
1086 Wayne Avenue  
Chambersburg, Pennsylvania USA  
Tel: [Int + 1] (717) 263-5100  
Fax: [Int + 1] (717) 267-0404

Europe, Africa, Middle East  
Sunderland SR4 6TT, England  
Tel: [Int + 44] 191 565-6281  
Parts Fax: [Int + 44] 191 510-9242  
Service Fax: [Int + 44] 191 510-9560

Constant improvement and engineering progress make it necessary that we reserve the right to make specification, equipment, and price changes without notice. Illustrations shown may include optional equipment and accessories and may not include all standard equipment.

Distributed By: