

National Series 900 Telescoping Crane

Designed Exclusively for the Canadian Market



*Load Rating Charts
for Model 990 (50,000-pound
capacity crane) without a jib
and with a 48-foot jib*

NATIONAL CRANE CORPORATION

876093

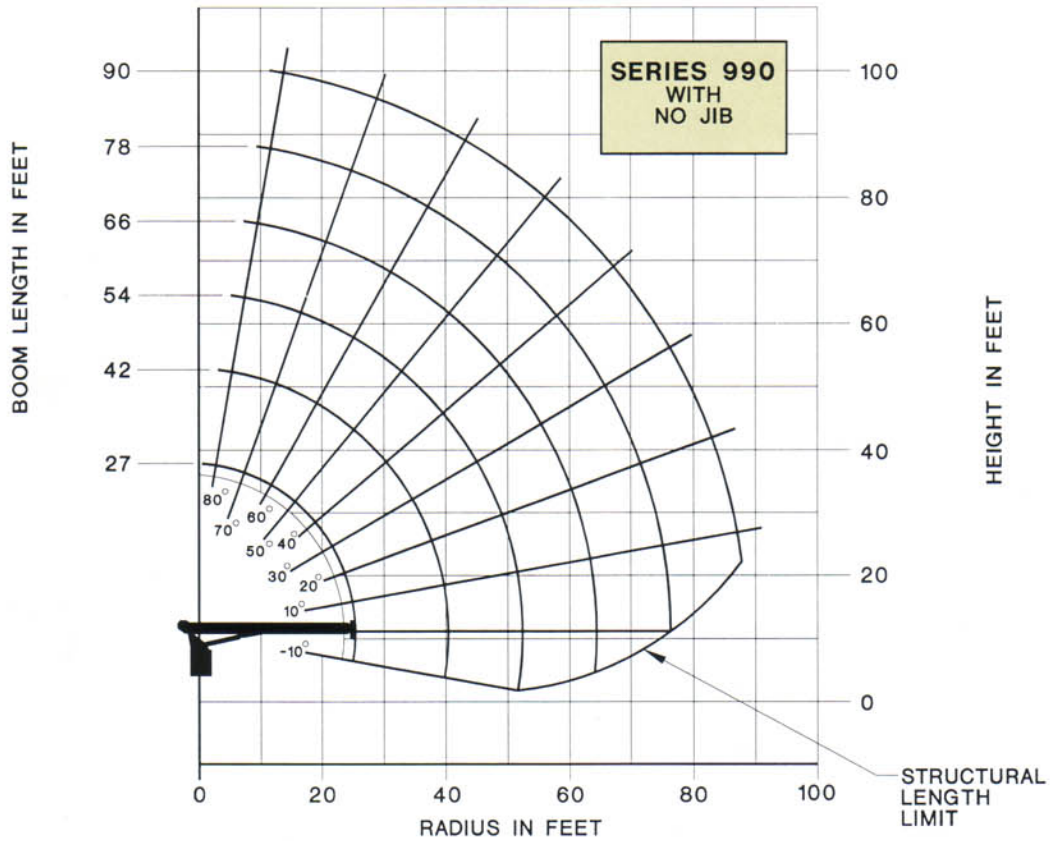

LOAD RATINGS

LOAD RADIUS (FEET)	LOADED BOOM ANGLE	27FT BOOM (LBS)	42FT BOOM (LBS)	42FT BOOM (LBS)	LOADED BOOM ANGLE	54FT BOOM (LBS)	LOADED BOOM ANGLE	66FT BOOM (LBS)	LOADED BOOM ANGLE	78FT BOOM (LBS)	LOADED BOOM ANGLE	90FT BOOM (LBS)
*4.75	79.4	50,000										
5	79	46,000										
8	72	33,000										
10	67	27,400	76½	23,900	80	22,300						
12	62	23,500	73½	20,900	77½	19,100						
14	57	20,500	70½	18,100	75½	16,700	79	15,400				
16	51	18,100	67½	16,100	73½	14,800	77	13,500	79½	12,600		
20	37	14,500	61	13,100	68½	12,000	73	11,000	76½	10,200	79	9,800
25			52½	10,500	62½	9,700	68½	8,900	72½	8,200	75½	7,700
30			43	8,650	56	8,100	63½	7,300	68½	6,700	72	6,200
35			30	6,950	49	6,700	58½	6,200	64½	5,650	68½	5,200
40					41	5,700	53	5,300	60	4,850	65	4,500
45					31½	4,700	47	4,800	55½	4,200	61½	3,900
50					17	3,400	40½	3,850	51	3,700	57½	3,350
55							32½	3,200	45½	3,200	53½	2,900
60							22	2,450	40	2,700	49	2,500
65									33	2,250	44½	2,150
70									25	1,750	39½	1,800
75									11	900	34	1,450
80											27	1,100
85											17	600

LOADLINE EQUIPMENT DEDUCT

DOWNHAUL WEIGHT = 150
 ONE SHEAVE BLOCK = 200
 TWO SHEAVE BLOCK = 355
 THREE SHEAVE BLOCK = 530

*REQUIRES 6x25 WIRE ROPE OPTION

1 PART LINE	2 PART LINE	3 PART LINE	4 PART LINE	5 PART LINE	6 PART LINE
MAX. PULL 7,700 LBS	MAX. PULL 15,400 LBS	MAX. PULL 23,100 LBS	MAX. PULL 30,800 LBS	MAX. PULL 38,500 LBS	MAX. PULL 50,000 LBS

NOTICE

DO NOT DEADHEAD LINE BLOCK AGAINST BOOM TIP WHEN EXTENDING BOOM.
 KEEP AT LEAST 3 WRAPS OF LOADLINE ON DRUM AT ALL TIMES.

USE ONLY 9/16" DIAMETER ROTATION RESISTANT CABLE WITH 38,500 LBS BREAKING STRENGTH ON THIS MACHINE.

MAXIMUM CAPACITY WITH "BURST OF SPEED" IS 3,000 LBS.

NATIONAL CRANE CORPORATION

876092

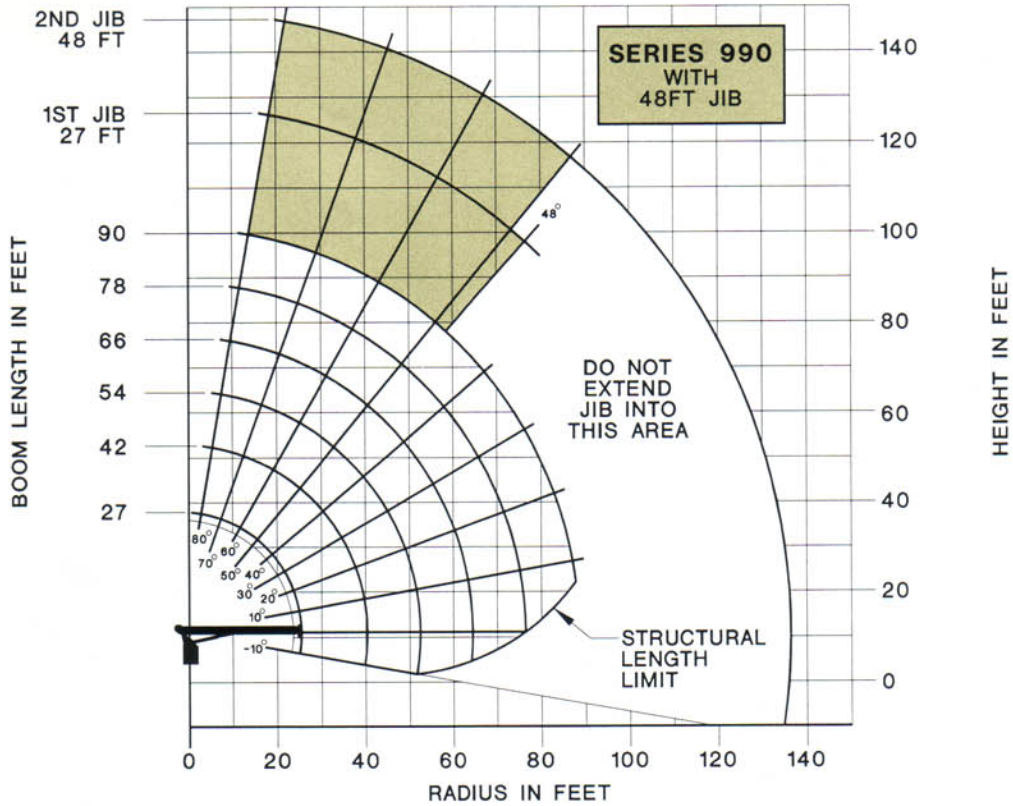

NOTE:

1. OPERATE WITH JIB BY RADIUS, WHEN MAIN BOOM IS FULLY EXTENDED. IF NECESSARY INCREASE BOOM ANGLE TO MAINTAIN LOADED RADIUS.
2. OPERATE WITH JIB BY BOOM ANGLE WHEN MAIN BOOM IS NOT FULLY EXTENDED. DO NOT EXCEED RATED JIB CAPACITIES AT ANY REDUCED BOOM LENGTHS.

LOAD RATINGS

LOAD RADIUS (FEET)	LOADED BOOM ANGLE	27FT BOOM (LBS)	LOADED BOOM ANGLE	42FT BOOM (LBS)	LOADED BOOM ANGLE	54FT BOOM (LBS)	LOADED BOOM ANGLE	66FT BOOM (LBS)	LOADED BOOM ANGLE	78FT BOOM (LBS)	LOADED BOOM ANGLE	90FT BOOM (LBS)	LOAD RADIUS (FEET)	LOADED BOOM ANGLE	27FT JIB (LBS)	LOADED BOOM ANGLE	48FT JIB (LBS)
4.75	79.4	50,000											30	77	4,800	79½	3,100
5	79	46,000											35	74½	4,300	77½	2,900
8	72	32,300											40	72	3,650	75½	2,700
10	67	28,700	76½	23,500	80	22,000							45	69	3,000	73½	2,500
12	62	22,800	73½	20,500	77½	18,800							50	66½	2,450	71½	2,300
14	57	19,800	70½	17,700	75½	16,400	79	15,200					55	63½	2,000	69½	2,100
16	51	17,400	67½	15,700	73½	14,500	77	13,300	79½	12,400			60	60½	1,600	67	1,800
20	37	13,800	61	12,700	68½	11,700	73	10,800	76½	10,000	79	9,500	65	57½	1,300	64½	1,500
25			52½	10,100	62½	9,400	68½	8,700	72½	8,000	75½	7,600	70	54½	1,000	62	1,250
30			43	8,250	56	7,800	63½	7,100	68½	6,500	72	6,100	75	51½	750	59½	1,050
35			30	6,550	49	6,400	58½	6,000	64½	5,450	68½	5,100	80	48	500	57	850
40					41	5,400	53	5,100	60	4,650	65	4,400	85			54	650
45					31½	4,400	47	4,400	55½	4,000	61½	3,800	90			51	450
50					17	3,100	40½	3,650	51	3,500	57½	3,250					
55							32½	3,000	45½	3,000	53½	2,800					
60							22	2,250	40	2,500	49	2,400					
65									33	2,050	44½	2,050					
70									25	1,550	39½	1,700					
75									11	700	34	1,350					
80											27	1,000					
85											17	500					

*REQUIRES 6x25 WIRE ROPE OPTION

LOADLINE EQUIPMENT DEDUCT

- DOWNHAUL WEIGHT = 150
- ONE SHEAVE BLOCK = 200
- TWO SHEAVE BLOCK = 355
- THREE SHEAVE BLOCK = 530

1 PART LINE	2 PART LINE	3 PART LINE	4 PART LINE	5 PART LINE	6 PART LINE
MAX. PULL 7,700 LBS	MAX. PULL 15,400 LBS	MAX. PULL 23,100 LBS	MAX. PULL 30,800 LBS	MAX. PULL 38,500 LBS	MAX. PULL 50,000 LBS

NOTICE

DO NOT DEADHEAD LINE BLOCK AGAINST BOOM TIP WHEN EXTENDING BOOM.
KEEP AT LEAST 3 WRAPS OF LOADLINE ON DRUM AT ALL TIMES.
USE ONLY 9/16" DIAMETER ROTATION RESISTANT CABLE WITH 38,500 LBS BREAKING STRENGTH ON THIS MACHINE.
MAXIMUM CAPACITY WITH "BURST OF SPEED" IS 3,000 LBS.

National Series 900 Booms and Jibs

Boom and Jib Combination

Series 900: 27 - 90 ft four section

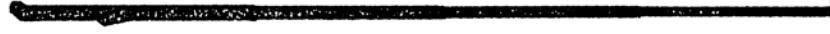

Series 900: 27 - 90 ft four section

9FJ48M: 27 - 48 ft manual pull-out



Reaches to 146 feet
The Series 900 is currently available in the two configurations shown above

- 1 The Series 900 with the 27-90 ft four section boom
- 2 Same as above with optional side-stowing jib: Model 9FJ48M, 27 - 48 ft manual pull-out







Do not operate crane booms, jib extensions, any accessories, or loads within 10 feet (3m) of live power lines or other conductors of electricity.

- 1 Load ratings shown on these charts are maximum allowable loads with the outriggers properly extended on a firm, level surface and the crane

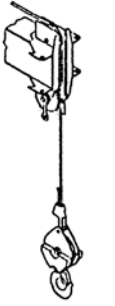
leveled and mounted on a factory-recommended truck

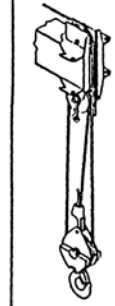
- 2 Always level the crane with the level indicator located on the crane frame
- 3 The operator must reduce loads to allow for factors such as wind, ground conditions, operating speeds and the effect of freely suspended loads

- 4 Overloading this crane may cause structural collapse or instability
- 5 Weights of any accessories attached to the boom or loadline must be deducted from the load chart capacities
- 6 Do not exceed jib capacities at any reduced boom lengths

NATIONAL SERIES 900 WINCH DATA			1 Part Line	2 Part Line	3 Part Line	4 Part Line	5 Part Line	6 Part Line
CAUTION								
<ul style="list-style-type: none"> • Do not deadhead lineblock against boom tip when extending boom • Keep at least three wraps of loadline on drum at all times • Use only 9/16" diameter rotation resistant cable with 38,500 pounds breaking strength on this machine • Maximum capacity with "Burst-of-Speed" is 3,000 pounds 								
Winch	Cable Supplied	Average Breaking Strength	Lift and Speed	Lift and Speed	Lift and Speed	Lift and Speed	Lift and Speed	Lift and Speed
Standard Planetary Winch	9/16" diameter rotation resistant 19 x 7 IWRC	38,500 lbs	7,700 lbs 164 fpm	15,400 lbs 82 fpm	23,100 lbs 55 fpm	30,800 lbs 41 fpm	38,500 lbs 33 fpm	46,000 lbs 27 fpm
	Optional 9/16" diameter 6 x 25 IWRC	29,750 lbs	7,700 lbs 164 fpm	15,400 lbs 82 fpm	23,100 lbs 55 fpm	30,800 lbs 41 fpm	38,500 lbs 33 fpm	46,000 lbs 27 fpm
with "Burst-of-Speed" Feature	Same as corresponding cable data shown above		3,000 lbs 265 fpm	6,000 lbs 133 fpm	9,000 lbs 88 fpm	12,000 lbs 66 fpm	15,000 lbs 53 fpm	18,000 lbs 44 fpm

All winch pulls and speeds are shown on the fourth layer. Winch pulls would increase on the first, second and third layers. Winch line pulls would decrease on the first, second, and third layers. Winch line pulls may be limited by the winch capacity or the cable safety factor. These are shown below:

Winch
With standard rotation resistant rope
With optional 6 x 25 IWRC rope

Bare Drum Pull
10,000 pounds
10,000 pounds

Allowable Cable Pull
7,700 pounds
8,400 pounds

National Series 900 Truck Specifications

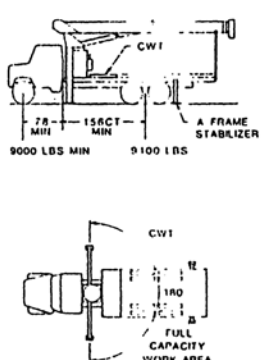
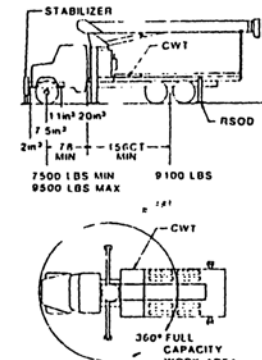
Mounting Configurations The versatility of the Series 900 can be enhanced by the mounting configurations described at the right. The configurations are based on the Series 900 with an 85% stability factor. The complete unit must be installed in accordance with factory requirements and a test performed to determine actual stability and counterweight requirements since individual truck chassis vary.	Configuration 1 with Torsion Box	Configuration 2 with Torsion Box
	This configuration is the least expensive mounting method for the Series 900. This mount, with the crane mounted behind the truck cab, requires the least weight of all mounts for stability, thus, you can haul larger payloads on your truck. It requires standard subbase and rear (RSOD) stabilizers.	This mount requires front stabilizers to give the machine full capacity 360° around the truck. Care must be taken in the selection of the truck. It must meet the minimum requirements shown below. The front stabilizer gives the machine a solid base, helping the operator control the loads precisely. Requires front and rear down-and-out stabilizers and a subbase. The truck frame must be made from 110,000 PSI steel. See "Truck Frame and Mounting Bolt Requirements for Front Stabilizer" statement on page 11. Contact the factory for details.
Stable	180°	360°
Gross Axle Weight Rating (GAWR), front	16,000 lbs	16,000 lbs
Gross Axle Weight Rating (GAWR), rear	34,000 lbs	34,000 lbs
Wheelbase (WB)	234 inches	231 inches
Cab to axle/trunnion (CA/CT)	156 inches	156 inches
Frame Section Modulus (SM) under crane 50,000 PSI or 110,000 PSI	35.0 inch ³ 15.9 inch ³	Not applicable (see note above) 20.0 inch ³
Frame Section Modulus (SM) over rear stabilizers: 50,000 PSI or 110,000 PSI	17.0 inch ³ 13.0 inch ³	Not applicable (see note above) 13.0 inch ³
Stability Weight, Front	7,500 lbs minimum *	7,500 lbs minimum *
Stability Weight, Rear	9,100 lbs minimum, RSOD *	9,100 lbs minimum, RSOD *
Estimated Average Final Weight	37,500 lbs	37,500 lbs
NOTES: (1) GAWR means Gross Axle Weight Rating and is dependent on all components of the vehicle such as axles, tires, springs, frame, etc meeting manufacturer's recommendations. Always specify GAWR when purchasing trucks. (2) Minimum axle requirements may increase with use of longer wheelbase, service bodies, diesel engines or front stabilizers. (3) Diesel engines require variable speed governor and energize-to-run fuel solenoid for smooth crane operation.		
* Estimated axle scale weights prior to installation of crane, stabilizers, and subbase for 85% sta		

National Boom Rests

Dimensional Specification

Series	Retracted Length	Extended Length	G	Dry* Wt/Lb	With Oil* Wt/Lb
990	27 ft	90 ft	98"	19,000*	19,800*

* Weight includes all items except RSOD (1200#)

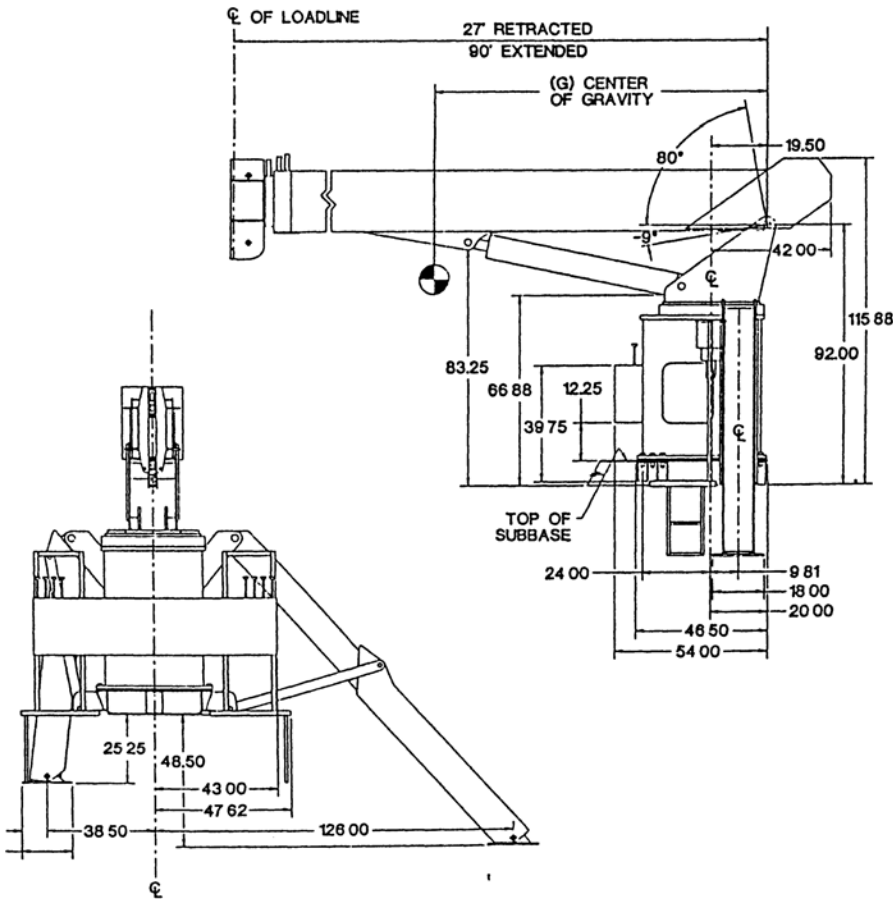
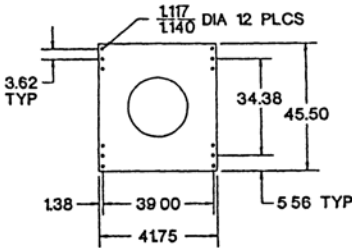

Cranes are tough when they're in use, but they can be severely damaged during travel from job to job. The only way a crane can be protected from this type of wear and damage is a strong, solid, boom rest.

Boom Rests

- Add years to the life of your crane
- Reduce stress on the crane frame
- Protect rotation gear from transit damage
- Remove stress from truck frame
- Spread crane load more evenly
- Reduce maintenance and downtime

In addition, boom rests are required to provide a positive way to immobilize your crane for transit.

National Crane supplies two heavy-duty boom rests for strong, sure protection of your crane. There is a quality National boom rest to fit your mounting configuration. All National Cranes must be fitted with a boom rest. All factory mounted cranes will be supplied with a boom rest.

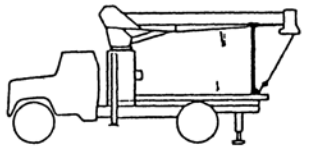

Horizontal rear bed mount for greater load space

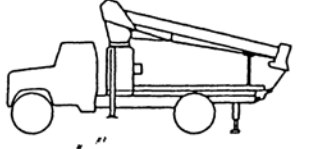

Low-profile rear bed mount for lower center of gravity