

**Link-Belt®**

# Wire Rope Truck Crane

75-ton (68.02 metric ton)

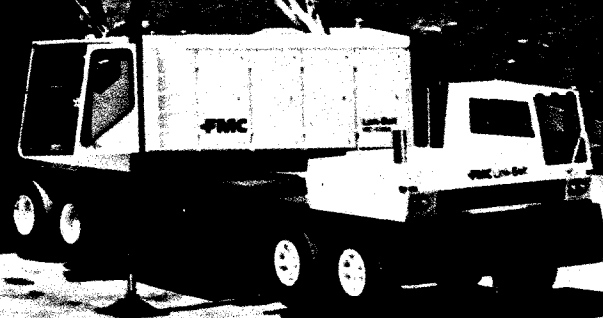

GENERAL INFORMATION ONLY

# EMC's exclusive low-profile Function Machinery Design

- 1
- 2
- 3
- 4
- 5
- 6
- 7
- 8
- 9
- 10
- 11

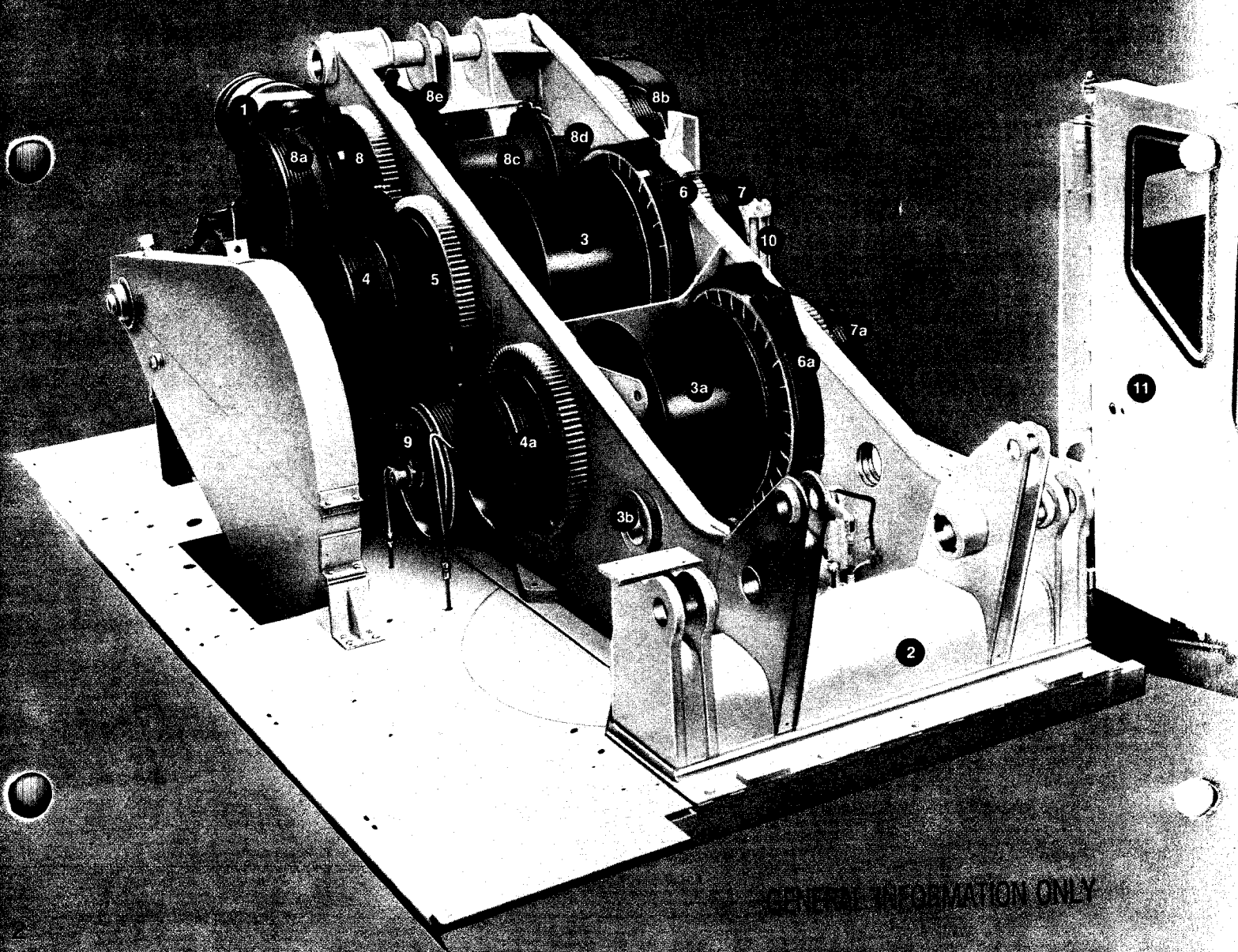

GENERAL INFORMATION ONLY

The 75-ton (68.02 metric ton) HC-138A Link-Belt® truck crane features the FMC exclusive stylized cab design for more effective operator performance.

The power train is FMC's exclusive **Full-Function design**. A precision built, all-gear drive unit that permits independent or simultaneous performance of all the crane functions.

The modular and humanized **operator cab** is designed for arm-chair control and optimum visibility. Upholstered seat, arm rest, sound reduction materials, etc. are all standard equipment.

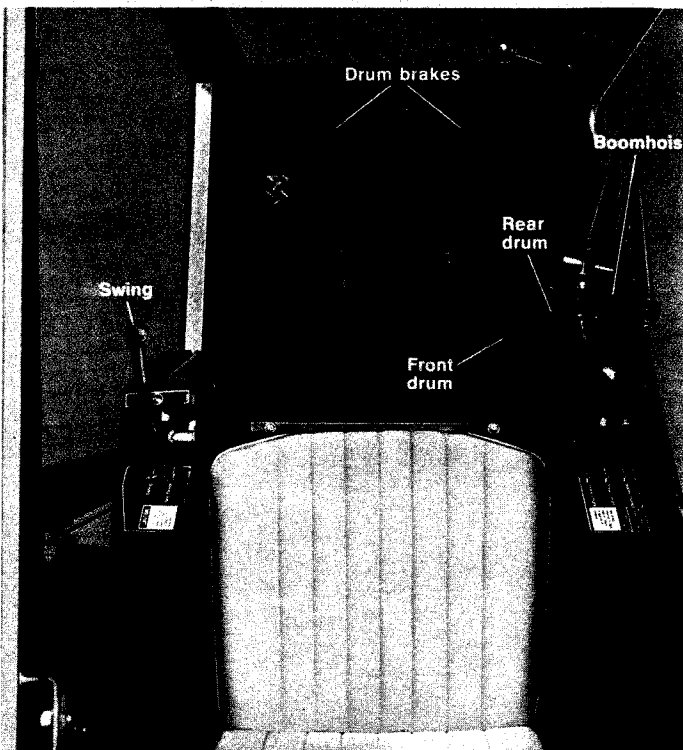

**Operator cab**

To assist operator in precision load hoisting or lowering particularly with long boom/jib, **drum rotation indicator buttons** on the drum clutch control levers pulsate whenever rope drums rotate to indicate both load speed and direction.

For superb control of all the crane functions, the HC-138A incorporates the exclusive **Speed-o-Matic power**



**Drum rotation indicator buttons**

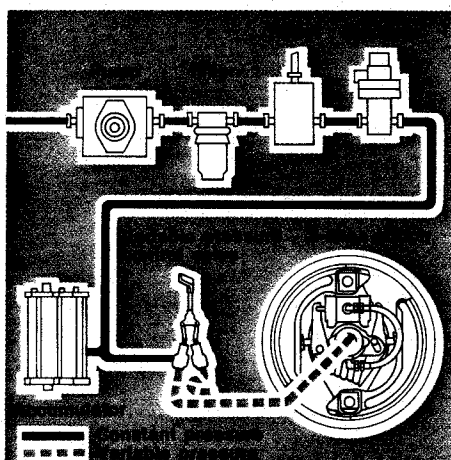

**Speed-o-Matic power hydraulic control system**

**hydraulic control system** and 2-shoe clutches. Short throw levers on operator's control consoles actuate variable pressure valves from which oil under pressure is metered to the 2-shoe clutch cylinders. Clutches can be engaged to any degree for smooth acceleration/deceleration of swing, load hoist/lowering and the boomhoist.



# Carrier designed and manufactured by FMC's Crane and Excavator Division

*Luxurious carrier cab insulated and isolated for sound level reduction*

The model HC-138A carrier is designed with a 100,000 p.s.i. (689 500 kPa) quench and tempered, high-strength alloy steel frame for optimum weight-to-strength ratio — an important consideration in the HC-138A axle loadings for machine transportability.

The **carrier cab** interior provides a touch of luxury for the operator. The cab is insulated and isolated from the frame by rubber mounts to reduce shock and sound levels. Upholstered side panels, luxury instrument panel, excellent gauge visibility, floor carpet, large glass area, bucket seat with safety belt, right and left-hand mirrors, windshield washers and wipers, heater, defroster fan, and tachometer are all standard equipment on the HC-138A.

The carrier **diesel engine** drives through a **Roadranger 15-speed transmission**, into a **2-speed** (direct and low) **auxiliary transmission**, powering the rear axle **planetaries**. This **power train** allows for negotiating steep grades, maneuvering through traffic, and travelling at highway speeds up to 40.2 m.p.h. (64.68 km/hr). In addition, the low range provides for on-the-job precision travel movement as low as 1.0 m.p.h. (1.61 km/hr).

Eight-wheel air brakes are standard. When lifting "on tires", parking brake can be set from the carrier cab. The brake chambers on the rear tandem also provide emergency braking.



Carrier cab

Hydraulic **front center jack** (optional) allows handling of the over-the-side outrigger capacities throughout 360° swing (refer to page #6). The control is located on the right front corner of the carrier.

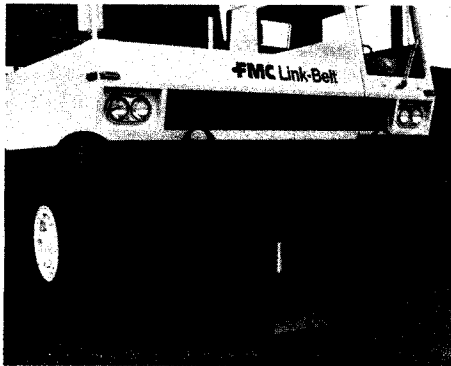

Front center jack

Power for the hydraulic outriggers is from the carrier engine-driven pump, with individual control of beams and jacks. This permits leveling the machine on reasonably uneven terrain. Once the outriggers are set, a **check valve** fixed to the jack cylinder "locks" the oil in the cylinder and the outrigger jacks in place. For assistance in leveling, sight levels are located near the outrigger boxes.

Both front and rear outrigger boxes are pin-connected to the carrier frame for quick removal to reduce over-all weight for highway travel. Removal of four pins in each frees the outrigger from the

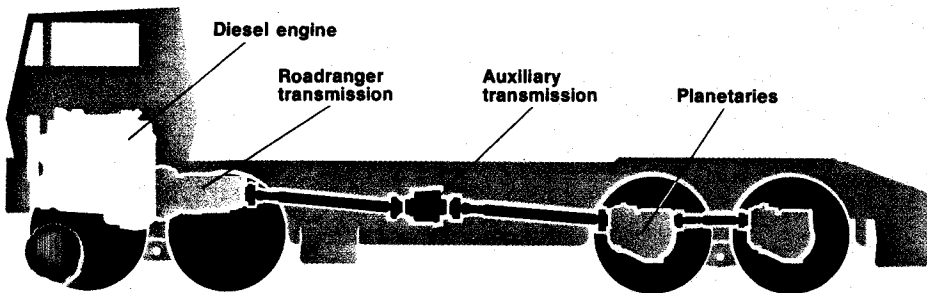
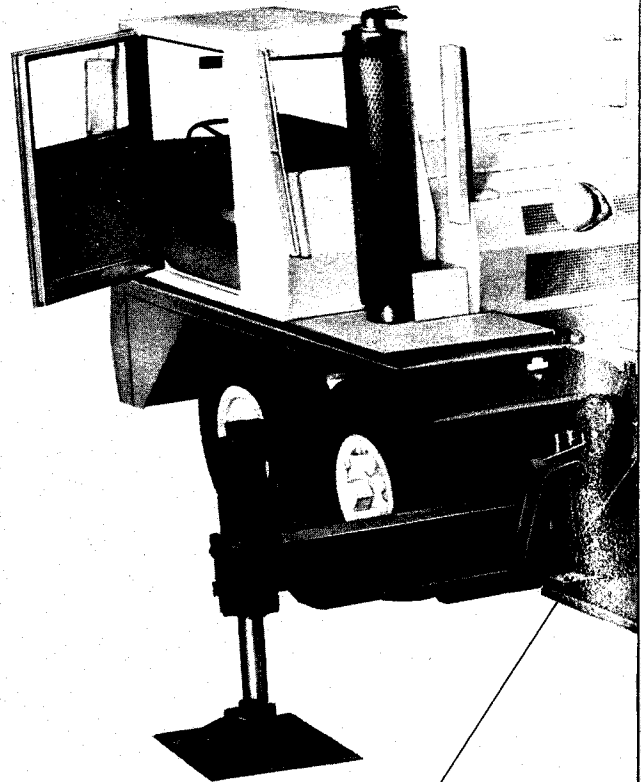

Carrier power train

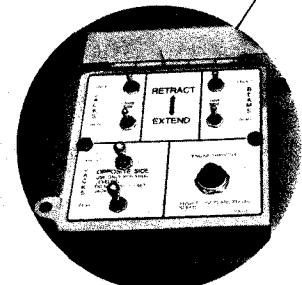

Outrigger control panel

GENERAL INFORMATION ONLY

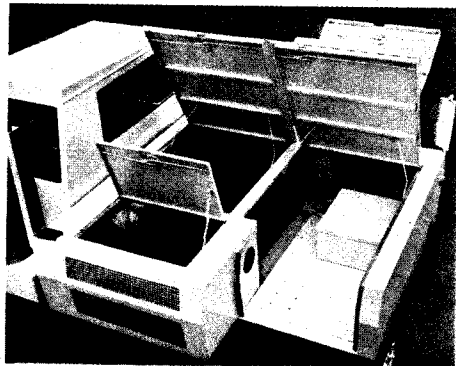

**Engine accessibility**

carrier. Hydraulic lines are equipped with quick disconnects. Also, to facilitate removal of the front outrigger assembly, the jack cylinder can be disassembled from one outrigger beam. (See page #8)

The **outrigger control panels** are located on each side of the carrier. Control panels are equipped with an engine "throttle" control.

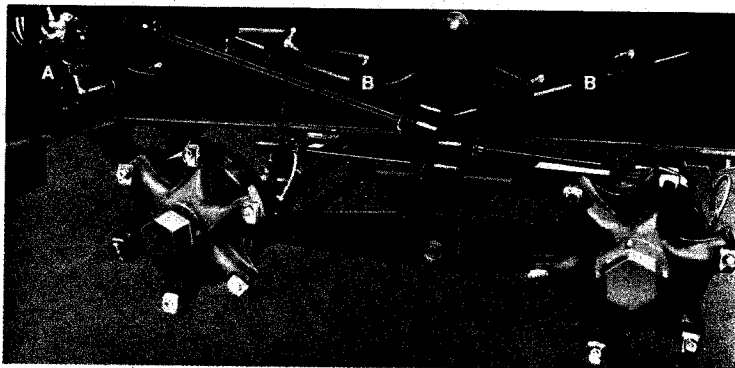

**Power assist hydraulic steer**

For complete service **accessibility to the engine** and accessories, the hood can be quickly raised.

The **power assist hydraulic steer** components are mounted to the side of the carrier frame for protection. The operator controls steering gear (A) and steer linkage. A hydraulic control valve activated by the steering gear (A) directs oil from the steering pump to the

interconnected, double-acting cylinders (B) for power assist hydraulic steer. This design results in equal power assist force when steering right or left.

The revolving upperstructure is mounted to the carrier by a turntable bearing with integral swing gear.

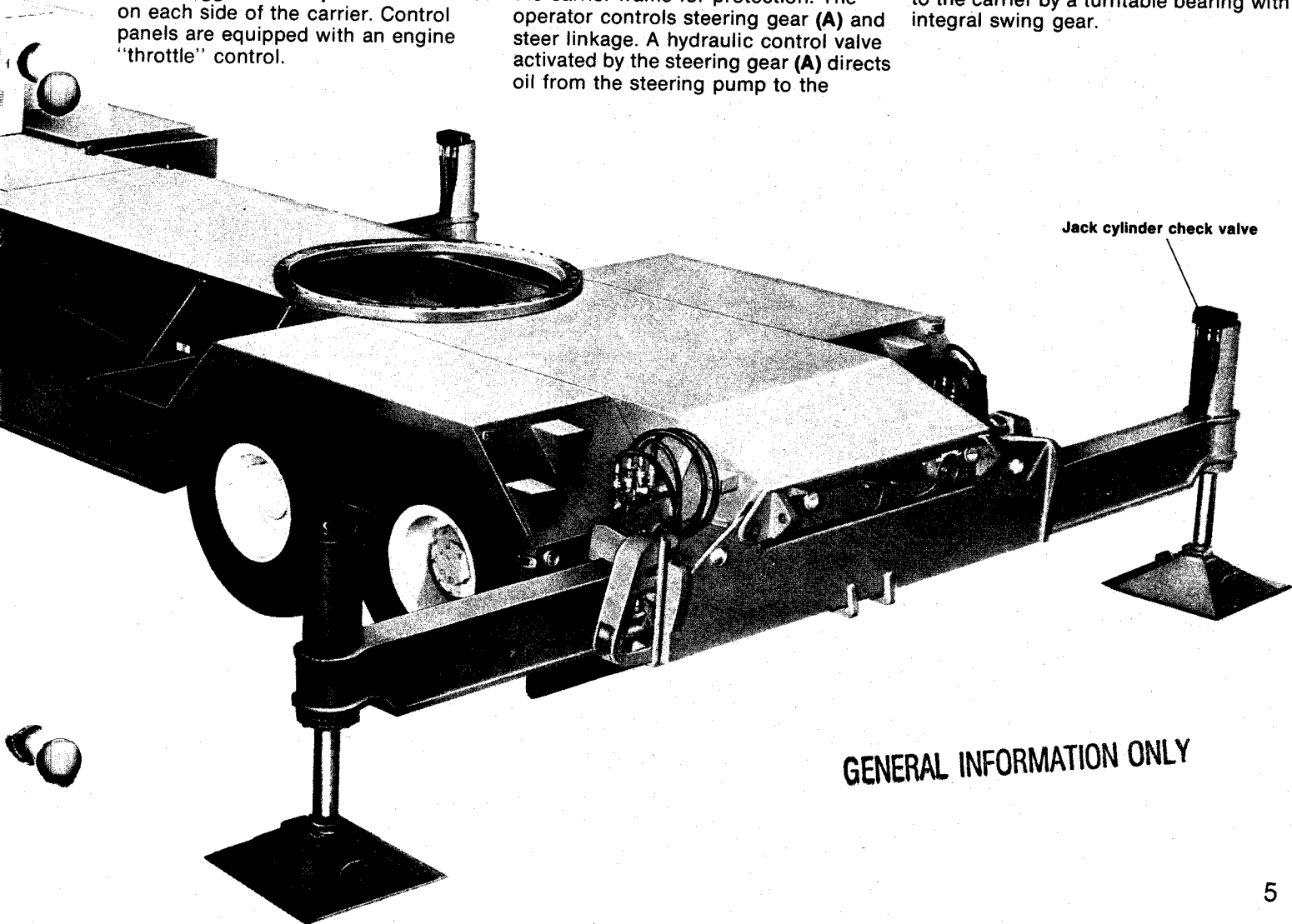

GENERAL INFORMATION ONLY



# Pin-connected tubular boom and jib

## Two types of boom top sections available

Up to 200' (60.96 m) main boom, or 190' (57.91 m) boom plus 50' (15.24 m) jib

GENERAL INFORMATION ONLY

The HC-138A features a pin-connected tubular boom and jib. Tubular boom chord members are 100,000 p.s.i. (689 500 kPa) quench and tempered, high-strength alloy steel.

The tubular boom represents the latest advances in boom design and is precision built with special automatic machine tools and fixtures. Machine-coped lattice ends match the contour of the round, alloy steel, tubular chords and are carefully welded in place with 360° welds.

The method of welding the in-line pin lugs to the round tube chord minimizes stress concentration and is an exclusive development of FMC engineering/manufacturing technology. The

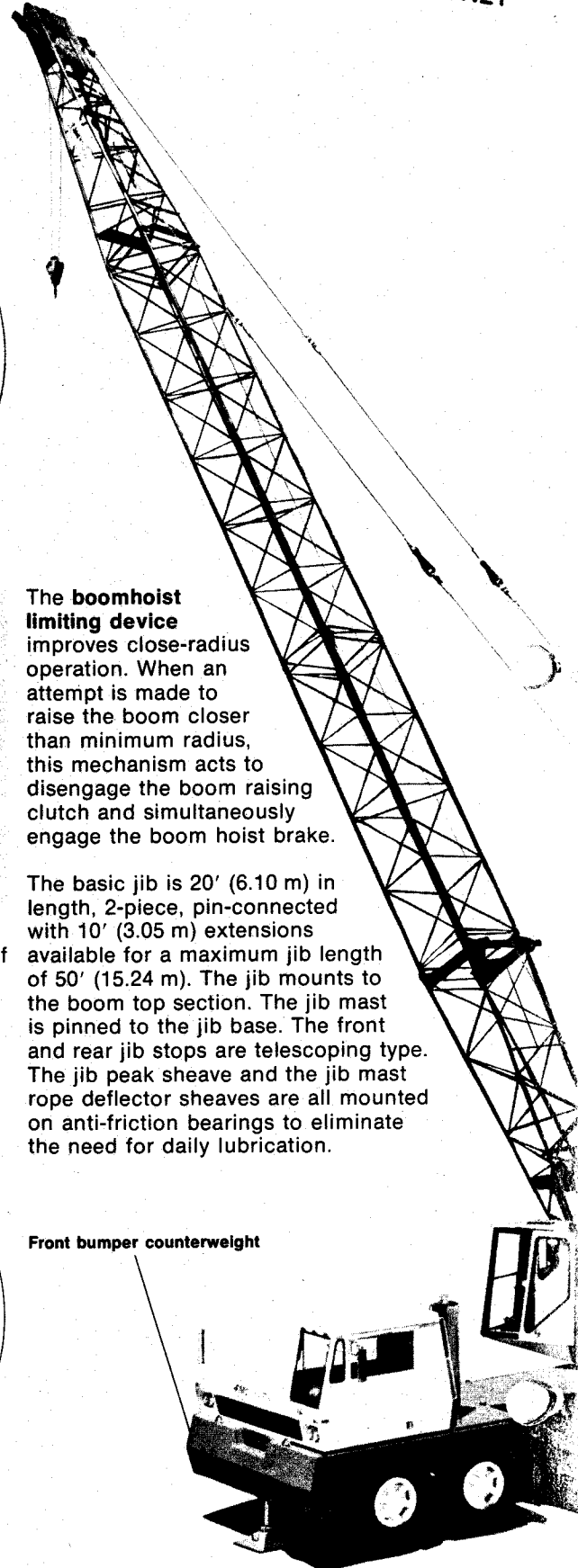
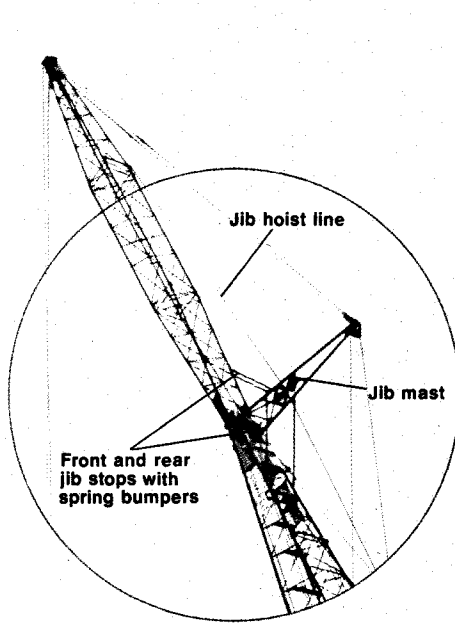

### The boomhoist limiting device

improves close-radius operation. When an attempt is made to raise the boom closer than minimum radius, this mechanism acts to disengage the boom raising clutch and simultaneously engage the boom hoist brake.

The basic jib is 20' (6.10 m) in length, 2-piece, pin-connected with 10' (3.05 m) extensions available for a maximum jib length of 50' (15.24 m). The jib mounts to the boom top section. The jib mast is pinned to the jib base. The front and rear jib stops are telescoping type. The jib peak sheave and the jib mast rope deflector sheaves are all mounted on anti-friction bearings to eliminate the need for daily lubrication.

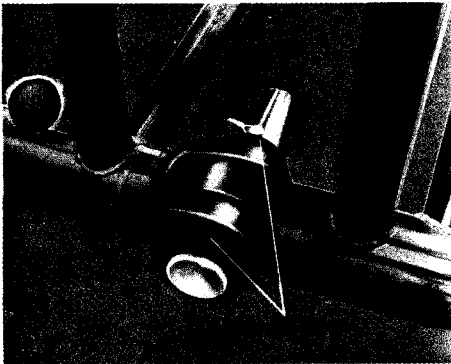

Boom pin-connection

**extended hub** on the female connection serves as an anchor for the jib guyline, mid-point pendants, or for pendant lines when assembling the boom. The **boom pin-connection** tapered end pin is held in place with a latchpin.

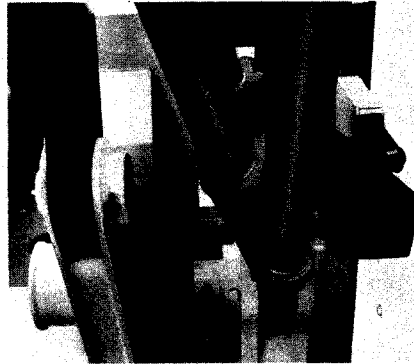

Boom hoist limiting device

The front center jack allows handling of the **over-the-side outrigger capacities throughout 360° swing**. This gives the HC-138A greater on-the-job working capability for increased truck crane performance and profits.

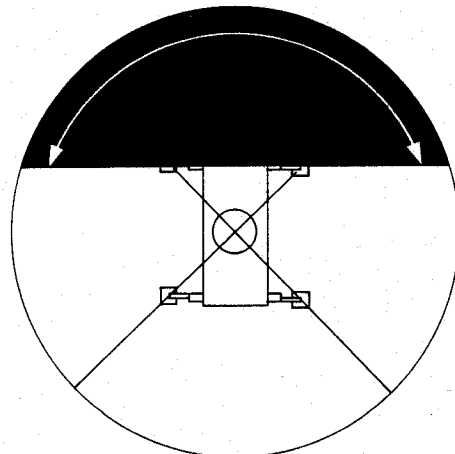

Over-the-side outrigger capacities throughout 360° swing with front center jack

Front bumper counterweight

## GENERAL INFORMATION ONLY

The flexibility of **Full-Function** design makes possible 2-speed front and rear rope drums and, at the same time, retain standard speed for swing, boomhoist and third drum. This exclusive, **independent planetary arrangement** (item 5, page 2) can be mounted at **either or both hoist and lowering ends** of the drum shafts.

Planetary is mounted between the drum gear and 2-shoe clutch drum. The planetary arrangement can provide up to 70% increased hoist speed or can be modified to provide 40% decreased speed for either hoisting or lowering. Engaging the 2-shoe clutch provides standard rope speed; planetaries are controlled by push button located on each hoist drum control lever.

To meet user's job requirements, the HC-138A crane boom can be equipped with one of two types of boom top sections — **hammerhead** or **open throat**. All boom peak sheaves are

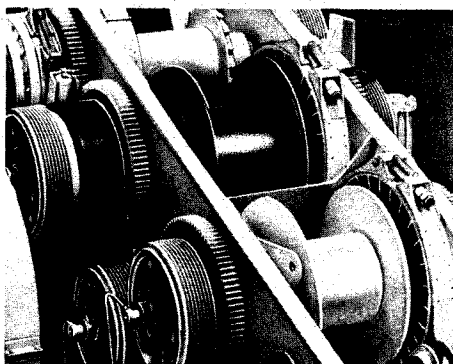

**Independent planetary driven 2-speed drums**

mounted on anti-friction bearings to eliminate the need for daily lubrication. The lower boom section is 20' (6.10 m) with various length boom extensions available.

boom is 190' (57.91 m) and boom and jib is 180' (54.86 m) plus 50' (15.24 m).

The 20' (6.10 m) **open throat top section** is equipped with five sheaves for multiple reeving to handle rated loads of 75 tons (68.02 metric ton) with boom length of 40' (12.19 m). Maximum length boom is 200' (60.96 m) and boom and jib is 190' (57.91 m) plus 50' (15.24 m).

**Dual, lever-type boom stops**, each with spring-loaded bumpers, are standard. When the **live mast** is used for assembly purposes, the boom stops can be arranged to serve as mast stops.

The boom live mast is equipped with sheaves and can be used for handling boom sections, counterweight, etc.

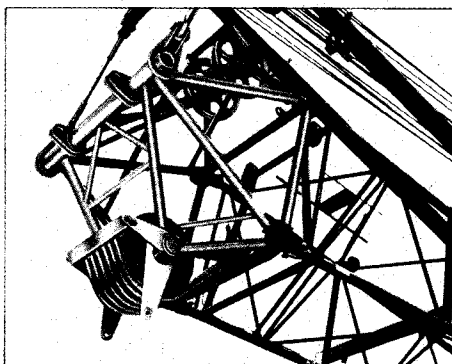

**Hammerhead top section**

The 5' (1.52 m) **hammerhead top section** is equipped with five sheaves for multiple reeving to handle rated loads of 75 tons (68.02 metric ton) with boom length of 25' (7.62 m). Maximum length

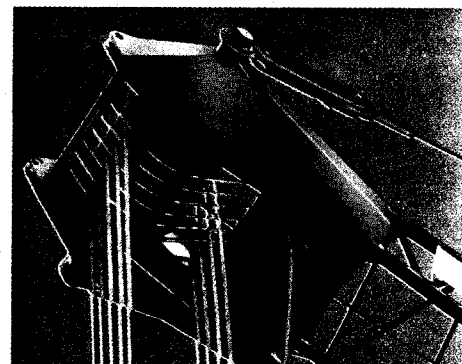

**Open throat top section**

**Boom folding with the 20' (6.10 m) open throat top section** is possible with the insertion of an optional 10' (3.05 m) boom section equipped with **offset lugs**. In addition, tubular **struts with offset lugs** are installed to mate with the offset lugs on the special section.

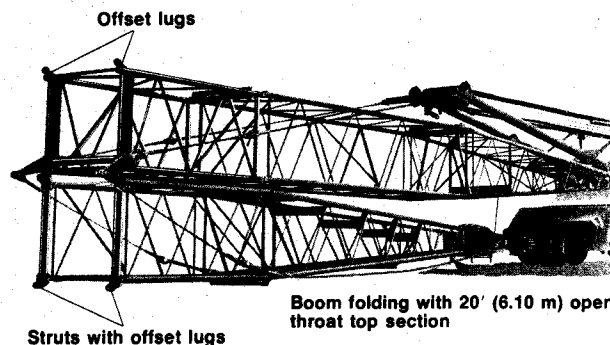
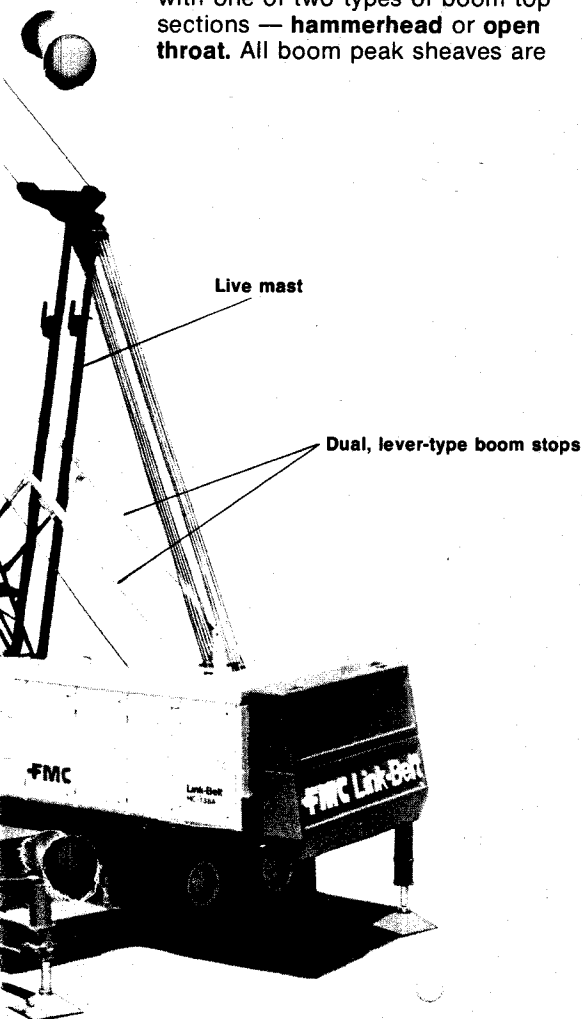

**Struts with offset lugs**

**Boom folding with 20' (6.10 m) open throat top section**

## Designed for fast stripdown of outriggers, boom and counterweight

The HC-138A is available for greater weight distribution

GENERAL INFORMATION ONLY

The HC-138A upperstructure machinery is fully enclosed within FMC's exclusive, distinguished and stylized cab. The cab is equipped with multiple side doors for accessibility to the machinery.

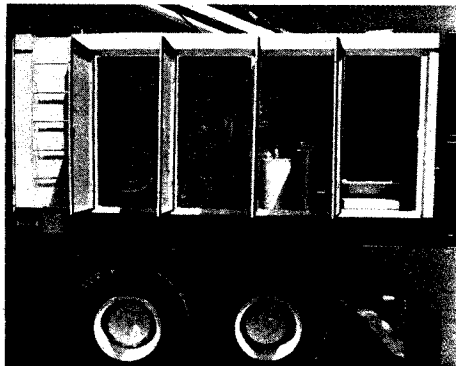

Machinery accessibility

Fast stripdown of the carrier bumper counterweight, upper counterweight and outrigger assemblies for job-to-job transportability was an important design consideration.

Bumper counterweight can be lifted off the two bumper lugs. Removal of two pins in each frees the front and rear outrigger assembly from the carrier. One jack assembly can be disassembled from the beam to facilitate removal of the front outrigger assembly from beneath the carrier. Hydraulic lines are equipped with quick disconnects. Floats are pin-connected to the jack cylinder rods. The crane upper counterweight can be lowered (or raised) hydraulically in just seconds. Counterweight is held in place

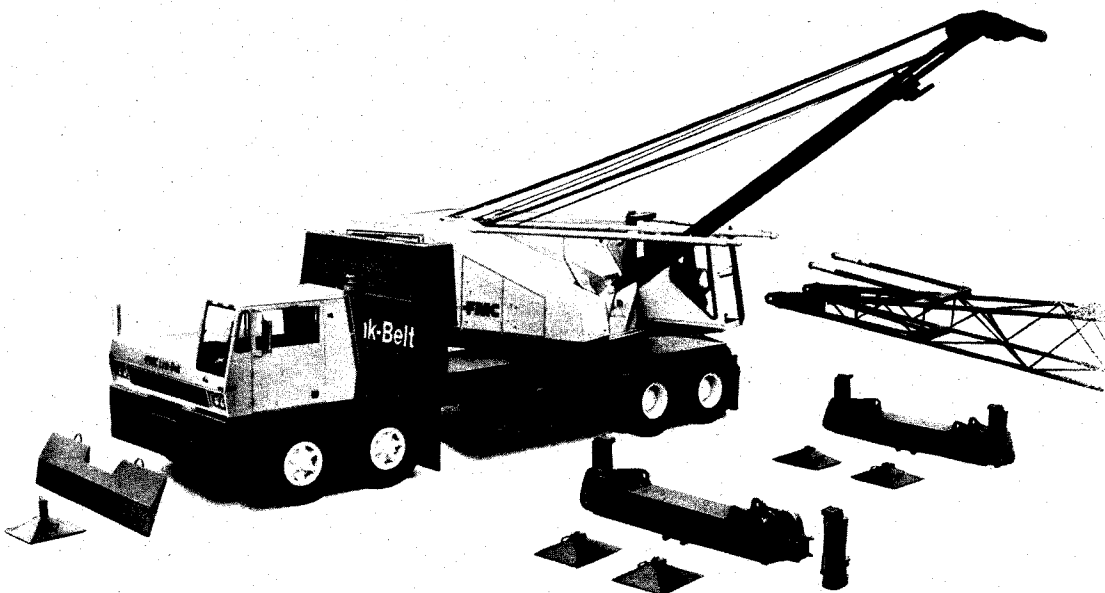

Fast stripdown of outriggers and counterweights

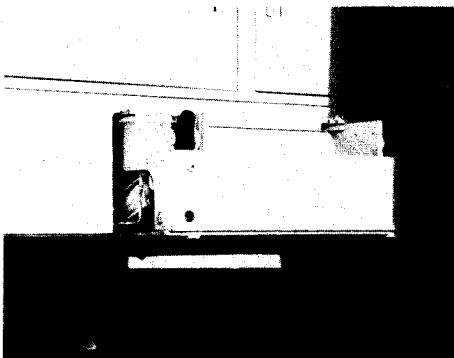

Hydraulic counterweight lowering

by the hydraulically controlled frustrums. Time consuming use of counterweight bolts or mechanical devices have been eliminated.

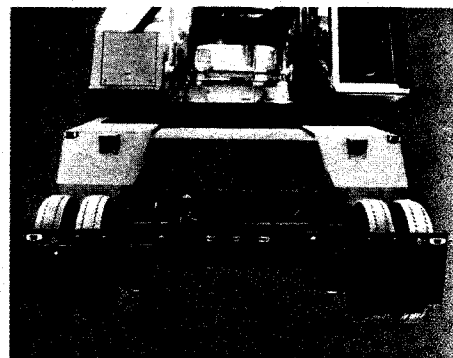

Rear tag axle

The HC-138A can be equipped with a tag axle, allowing greater over-all payload.

### Carrier features

- FMC designed and manufactured  
**Benefit - Dependability and performance**
- Luxurious operator cab  
**Benefit - Increased operator efficiency**
- Roadranger 15-speed transmission  
**Benefit - Job-to-job mobility**
- Front center jack  
**Benefit - "Over-the-side" lift capacity through 360° swing**
- Auxiliary 2-speed transmission  
**Benefit - Low speed on-the-job travel**

### Upperstructure features

- Operator's cab forward mounted  
**Benefit - Greater operator visibility**
- Full-Function gear train design  
**Benefit - Permits independent or simultaneous crane functions for increased performance and production**
- Speed-o-Matic® power hydraulic system  
**Benefit - Proven and dependable. No daily system maintenance**
- Interchangeable 2-shoe clutches  
**Benefit - Serviceability, accessibility and performance**

- High speed planetary drive for load hoist  
**Benefit - Increases hoist cycles for greater production**

### Attachment features

- Choice of boom top sections  
**Benefit - User job flexibility**
- Tubular boom with 100,000 p.s.i. (689 500 kPa) alloy steel chords  
**Benefit - Dependability**
- Exclusive boom pin-connection design with extended hub on female connection  
**Benefit - Faster boom assembly and disassembly**

We are constantly improving our products and therefore reserve the right to change designs and specifications.

**FMC Corporation Cable Crane & Excavator Division Cedar Rapids Iowa 52406**

Link-Belt® cranes/excavators manufactured in: Cedar Rapids Iowa • Lexington & Bowling Green Kentucky • Ontario Canada • Milan Italy • Queretaro Mexico & Nagoya Japan (under license)