

**KOBELCO**

**HYDRAULIC CRAWLER CRANE**  
***CKL2600i***

Model: CKL2600i





**Max. Lifting Capacity: 260 t x 4.6 m**  
**Max. Crane Boom Length: 91.4 m**  
**Max. Fixed Jib Combination: 76.2 + 30.5 m**

# CONFIGURATION

**Crane Boom**

Max. Lifting Capacity:  
260 metric ton x 4.6 m

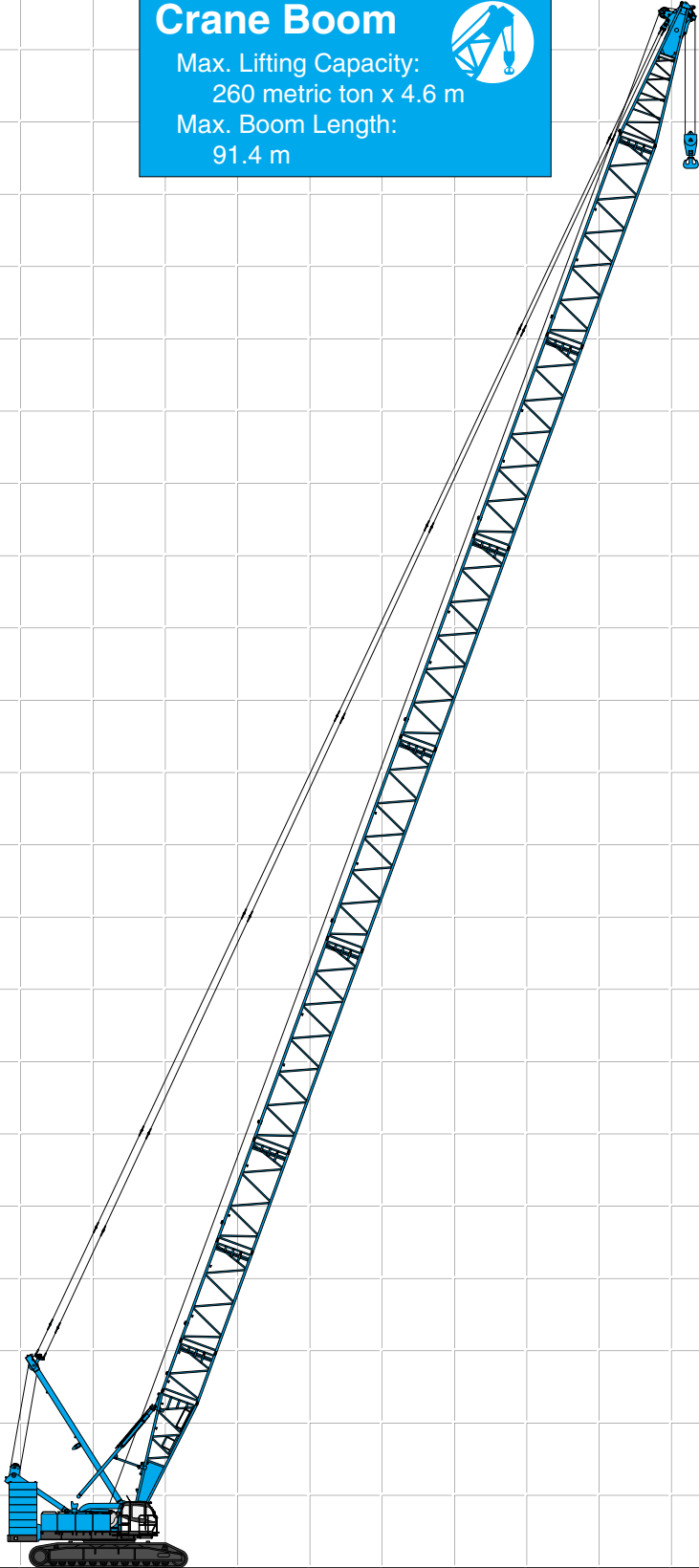
Max. Boom Length:  
91.4 m



**Fixed Jib**  
Max. Lifting Capacity:  
27 metric ton x 10.4 m  
Max. Combination:  
76.2 m + 30.5 m

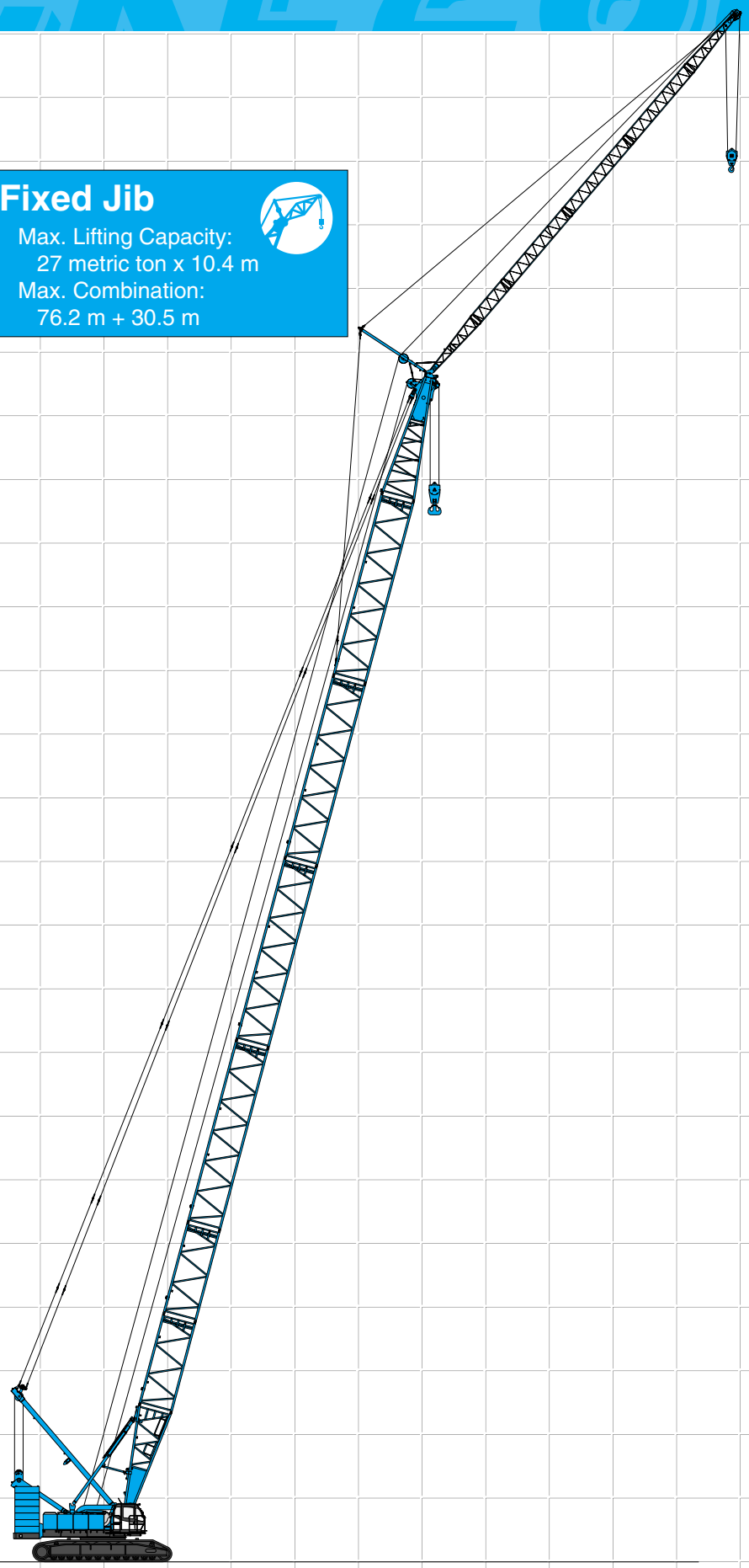

## CONTENTS

- Configuration ..... 1
- Specifications ..... 3
- General Dimensions ..... 5
- Boom and Jib Arrangements**
  - Crane Boom Arrangements ..... 7
  - Fixed Jib Arrangements ..... 8
- Working Ranges and Lifting Capacities**
  - Crane Boom Working Ranges ..... 9
  - Crane Boom Lifting Capacity ..... 10
  - Auxiliary Sheave Lifting Capacity for Crane Boom ..... 11
  - Fixed Jib Working Ranges ..... 12
  - Fixed Jib Lifting Capacities ..... 13
- Parts and Attachments ..... 15
- Self-Removal Device ..... 17

# SPECIFICATIONS



## Power Plant

**Model:** Hino diesel engine P11C-UN

**Type:** Water-cooled, direct fuel injection, with turbocharger  
Complies with NRMM (Europe) Stage IIIA and US EPA Tier III.

**Displacement:** 10.520 liters

**Rated Power:** 247 kW at 2,000 min<sup>-1</sup> {rpm} (ISO)

**Max. torque:** 1,300 N·m/1,500 min<sup>-1</sup>

**Cooling system:** Liquid, recirculating bypass

**Starter:** 24 V/6.0 kW

**Radiator:** Corrugated type core, thermostatically controlled

**Air cleaner:** Dry type with replaceable paper element

**Throttle:** Electric throttle control, twist grip type

**Fuel filter:** Replaceable paper element

**Batteries:** Two 12V, 150Ah/20HR capacity batteries, series connected.

**Fuel tank capacity:** 370 liters



## Hydraulic System

Four variable displacement piston pumps are driven by heavy-duty pump drive. Two of variable displacement pumps are used in the main hook hoist circuit, auxiliary hook hoist circuit, jib hoist circuit and each propel circuit. One of the other two pumps is used in the boom hoist circuit, and the other is used in the swing circuit.

**Control:** Full-flow hydraulic control system for infinitely variable pressure to front and rear drums, boom hoist drum and propel. Controls respond instantly to the touch, delivering smooth function operation.

**Cooling:** Oil-to-air heat exchanger (plate-fin type)

**Filtration:** Full-flow and bypass type with replaceable element

**Electrical system:** All wiring corded for easy servicing, individual fused branch circuits.

**Max. relief valve pressure:**

**Load hoist, boom hoist and propel system:**

31.9 MPa {325 kgf/cm<sup>2</sup>}

**Swing system:** 27.5 MPa {280 kgf/cm<sup>2</sup>}

**Control system:** 5.4 MPa {55 kgf/cm<sup>2</sup>}

**Reservoir capacity:** 600 liters



## Boom Hoisting System

Powered by a hydraulic motor through a planetary reducer.

**Brake:** A spring-set, hydraulically released multiple-disc brake is mounted on the boom hoist motor and operated through a counter-balance valve.

**Drum lock:** External ratchet for locking drum.

**Drum:** Double drum, grooved for 26 mm dia. wire rope.

**Line speed:** Double line on first drum layer

**Hoisting/Lowering:** 22 to 2 m/min x 2

**Diameter of wire ropes**

**Boom guy line:** 38 mm

**Boom hoist reeving:** 16 parts of 26 mm dia. high strength wire rope

**Boom backstops:** Required for all boom lengths



## Load Hoist System

Front and rear drums for load hoist powered by a hydraulic variable plunger motors, driven through planetary reducers.

**Negative Brake:** A spring-set, hydraulically released multiple-disc brake is mounted on the hoist motor and operated through a counter-balance valve. (Positive free fall brake is optional item.)

**Drum lock:** External ratchet for locking drum

**Drums:**

**Front drum:**

617.1 mm P.C.D. x 833.7 mm Lg. wide drum, grooved for 25 mm wire rope. Rope capacity is 480 m working length and 600 m storage length.

**Rear drum:**

617.4 mm P.C.D. x 833.7 mm Lg. wide drum, grooved for 25 mm wire rope. Rope capacity is 390 m working length and 600 m storage length.

Note: Rope lengths listed above denote drum capacity and may differ from actual rope lengths supplied when machinery is shipped.

**Line speed:** Single line on the first drum layer

**Hoisting/Lowering:** 100 to 3 m/min

**Line Pull (Single-line):**

**Rated line pull:** 132 kN {13.5 tf}



## Swing System

Swing unit is powered by hydraulic motor driving spur gears through planetary reducers (2 sets), the swing system provides 360° rotation.

**Swing parking brakes:** A spring-set, hydraulically released multiple-disc brake is mounted on swing motor.

**Swing circle:** Single-row ball bearing with an integral internally cut swing gear.

**Swing lock:** Manually, four position lock for transportation

**Swing speed:** 2.0 min<sup>-1</sup> {rpm}



## Upper Structure

Torsion-free precision machined upper frame. All components are located clearly and service friendly. Engine with low noise level. Complies with EC Directive 2000/14/EC.

**Counterweight:** 90.0 t



## Cab & Control

Totally enclosed, full vision cab with safety glass, fully adjustable, high backed seat with a head-rest and armrests, and intermittent wiper and window washer (skylight and front window).

### Cab fittings:

Air conditioner, convenient compartment (for tool), cup holder, ashtray, cigarette lighter, sun visor, roof blind, tinted glass, floor mat, foot-rest, shoe tray

### Controls:

Four adjustable levers for front drum, rear drum, boom drum and swing controls, and boom hoist pedal.



## Lower Structure

Steel-welded carbody with axles. Crawler assemblies are designed with quick disconnect feature for individual removal as a unit from axles. Crawler belt tension is maintained by hydraulic jack force on the track-adjusting bearing block.

**Carbody weight:** 24.0 t

**Crawler drive:** Independent hydraulic propel drive is built into each crawler side frame. Each drive consists of a hydraulic motor propelling a driving tumbler through a planetary gear box. Hydraulic motor and gear box are built into the crawler side frame within the shoe width.

**Crawler brakes:** Spring-set, hydraulically released parking brakes are built into each propel drive.

**Steering mechanism:** A hydraulic propel system provides both skid steering (driving one track only) and counter-rotating steering (driving each track in opposite directions).

**Track rollers:** Sealed track rollers for maintenance-free operation.

**Shoes (flat):** 68 shoes, 1,220 mm wide each crawler  
(Optional 1,330 mm shoe is available)

**Max. travel speed:** 1.1/0.7 km/h

**Max. gradeability:** 30%



## Weight

Including upper and lower machine, 90.0 ton counterweight and 24.0 ton carbody weight, basic boom (or basic boom + basic jib), hook, and other accessories.

Specification	Weight	Ground pressure
Crane boom	Approx. 214 t, 109 kPa	{1.11 kgf/cm <sup>2</sup> }
Fixed jib	Approx. 215 t, 109 kPa	{1.11 kgf/cm <sup>2</sup> }



## Attachment

### Boom and Jib:

Welded lattice construction using tubular, high-tensile steel chords with pin connections between sections.

### Boom and Jib Length

	Min. Length (Min. Combination)	Max. Length (Max. Combination)
Crane Boom	15.2 m	91.4 m
Fixed Jib	27.4 m + 12.2 m	76.2 m + 30.5 m

## Main Specifications (Model: CKL2600i)

Crane Boom	
Max. Lifting Capacity	260 t/4.6 m
Max. Length	91.4 m
Fixed Jib	
Max. Lifting Capacity	27 t/10.4 m
Max. Length	30.5 m
Max. Combination	76.2 m + 30.5 m
Luffing Jib : OPTIONAL	
Max. Lifting Capacity	80 t/9.8 m
Jib Length	21.3 m ~ 61.0 m
Max. Combination	61.0 m + 61.0 m
Luffing Angle	63° ~ 88°
Main & Aux. Winch	
Max. Line Speed	100 m/min (1st layer)
Rated Line Pull (Single Line)	132 kN {13.5 tf}
Wire Rope Diameter	25.4 mm
Wire Rope Length	480 m (Main) 390 m (Aux.)
Brake Type	Spring set hydraulically released (Negative)
Free-Fall Brake Type	Wet-type multiple disc brake (Optional)
Working Speed	
Swing Speed	2.0 min <sup>-1</sup> {2.0 rpm}
Travel Speed	1.1/0.7 km/h

Power Plant	
Model	Hino P11C-UN
Engine Output	247 kW/2,000 min <sup>-1</sup> {rpm}
Fuel Tank Capacity	370 liters
Hydraulic System	
Main Pumps	4 variable displacement
Max. Pressure	31.9 MPa {325 kgf/cm <sup>2</sup> }
Hydraulic Tank Capacity	600 liters
Self-Removal Device	
	Standard
Weight	
Operating Weight*	Approx. 214 t
Ground Pressure*	109 kPa {1.11 kgf/cm <sup>2</sup> }
Counterweight	90.0 t (Upper), 24.0 t (Lower)
Transport Weight**	Approx. 46.0 t

\* Including upper and lower machine, 90.0 t counterweight and 24.0 t carbody weight, basic boom, hook, and other accessories.

\*\* Base machine with trans-lifter, main and aux. winches (non-free fall) including wire rope, and boom hoist winch including wire rope.

Units are SI units. { } indicates conventional units.

# GENERAL DIMENSIONS

## Crane Boom

(Unit: mm)

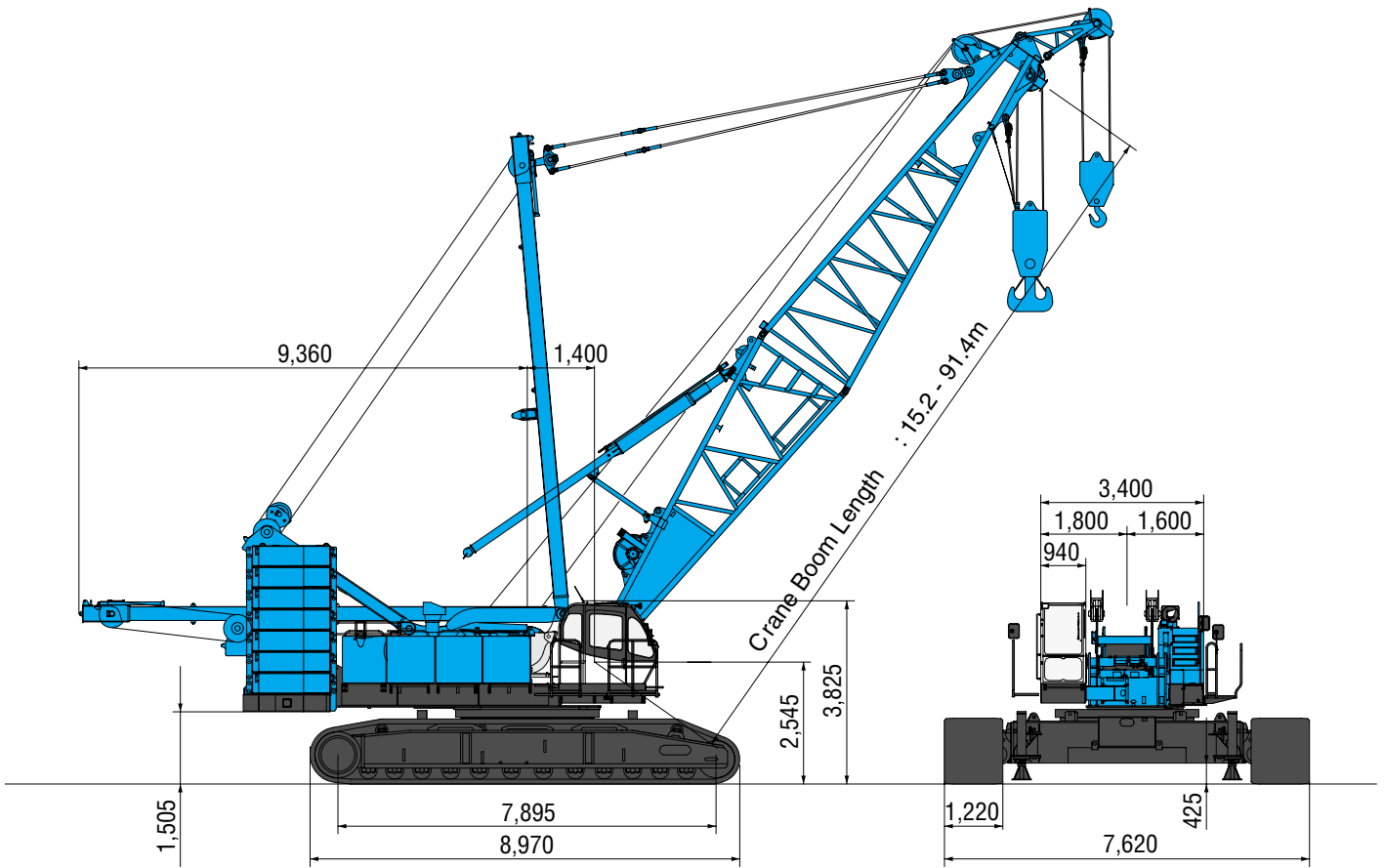

## Limit of Hook Lifting

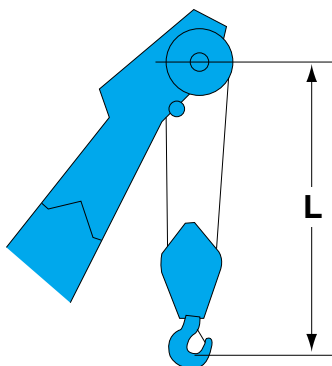

Hook	L
260 t hook	5.3 m
150 t hook	5.9 m
70 t hook	4.9 m
35 t hook	4.7 m

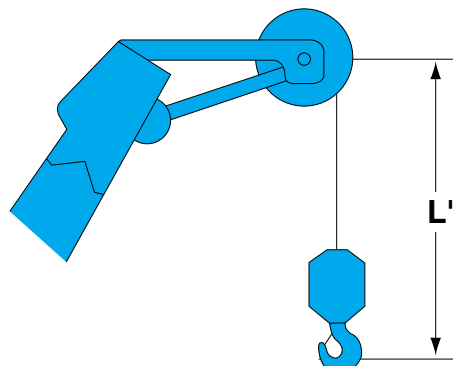

Hook	L'
35 t hook	3.8 m
13.5 t ball hook	3.5 m



# BOOM AND JIB ARRANGEMENTS

## Crane Boom Arrangements

Boom length m (ft)	Boom arrangement
15.2 (50)	
18.3 (60)	
21.3 (70)	※
24.4 (80)	※
27.4 (90)	※
30.5 (100)	※
33.5 (110)	※
36.6 (120)	※
39.6 (130)	※
42.7 (140)	※
45.7 (150)	※
48.8 (160)	※
51.8 (170)	※

Boom length m (ft)	Boom arrangement
54.9 (180)	※
57.9 (190)	※
61.0 (200)	※
64.0 (210)	※
67.1 (220)	※
70.1 (230)	※
73.2 (240)	※
76.2 (250)	※
79.3 (260)	※
82.3 (270)	※
85.3 (280)	※
88.4 (290)	※
91.4 (300)	※

Symbol	Boom Length	Remarks
	7.6 m	Boom Base
	7.6 m	Boom Top
	3.0 m	Insert Boom
	6.1 m	Insert Boom
	12.2 m	Insert Boom

↗ mark shows the guy line installing position when the fixed jib is used.

※ Indicates the most flexible combination of insert booms, which can be modified to form all shorter boom arrangements.



## Fixed Jib Arrangements

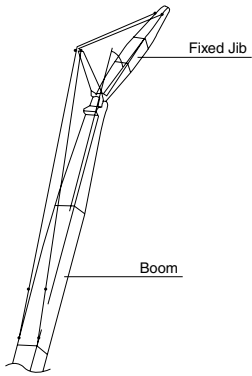

Crane boom length	Jib length m (ft)	Jib arrangement
27.4 m	12.2 (40)	
	18.3 (60)	
76.2 m	24.4 (80)	
	30.5 (100)	

Symbol	Jib Length	Remarks
	4.6 m	Jib Base
	4.6 m	Jib Top
	3.0 m	Insert Jib
	6.1 m	Insert Jib



### Hook Blocks

A range of hook blocks can be specified, each with a safety latch.

Hooks	Weight (kg)	No. of sheaves	No. of lines and max. rated loads (t)							
			1	2	3	4	5	6	7	8
260-t	4,160	11	-	-	-	54.0	-	81.0	-	108.0
150-t	2,300	6	-	-	40.5	54.0	67.5	81.0	94.5	108.0
70-t	1,200	3	-	27.0	40.5	54.0	67.5	70.0	-	-
35-t	900	1	-	27.0	35.0	-	-	-	-	-
13.5-t ball hook	450	0	13.5	-	-	-	-	-	-	-

Hooks	Weight (kg)	No. of sheaves	No. of lines and max. rated loads (t)							
			9	10	12	14	16	18	20	22
260-t	4,160	11	-	135.0	160.0	183.0	205.0	227.0	240.0	260.0
150-t	2,300	6	121.5	135.0	150.0	-	-	-	-	-
70-t	1,200	3	-	-	-	-	-	-	-	-
35-t	900	1	-	-	-	-	-	-	-	-
13.5-t ball hook	450	0	-	-	-	-	-	-	-	-



### Main Hoist Drum Rated Loads in Metric Tons

No. of Parts of Line	1	2	3	4	5	6	7	8
Max. Loads (t)	13.5	27.0	40.5	54.0	67.5	81.0	94.5	108.0
No. of Parts of Line	9	10	12	14	16	18	20	22
Max. Loads (t)	121.5	135.0	160.0	183.0	205.0	227.0	240.0	260.0

### Symbols for Attachments:

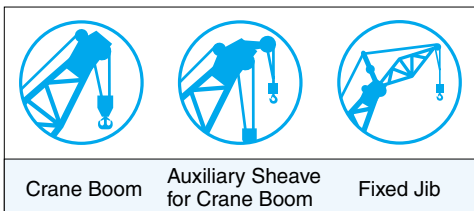

Crane Boom

Auxiliary Sheave for Crane Boom

Fixed Jib

# WORKING RANGES AND LIFTING CAPACITIES

## Crane Boom Working Ranges

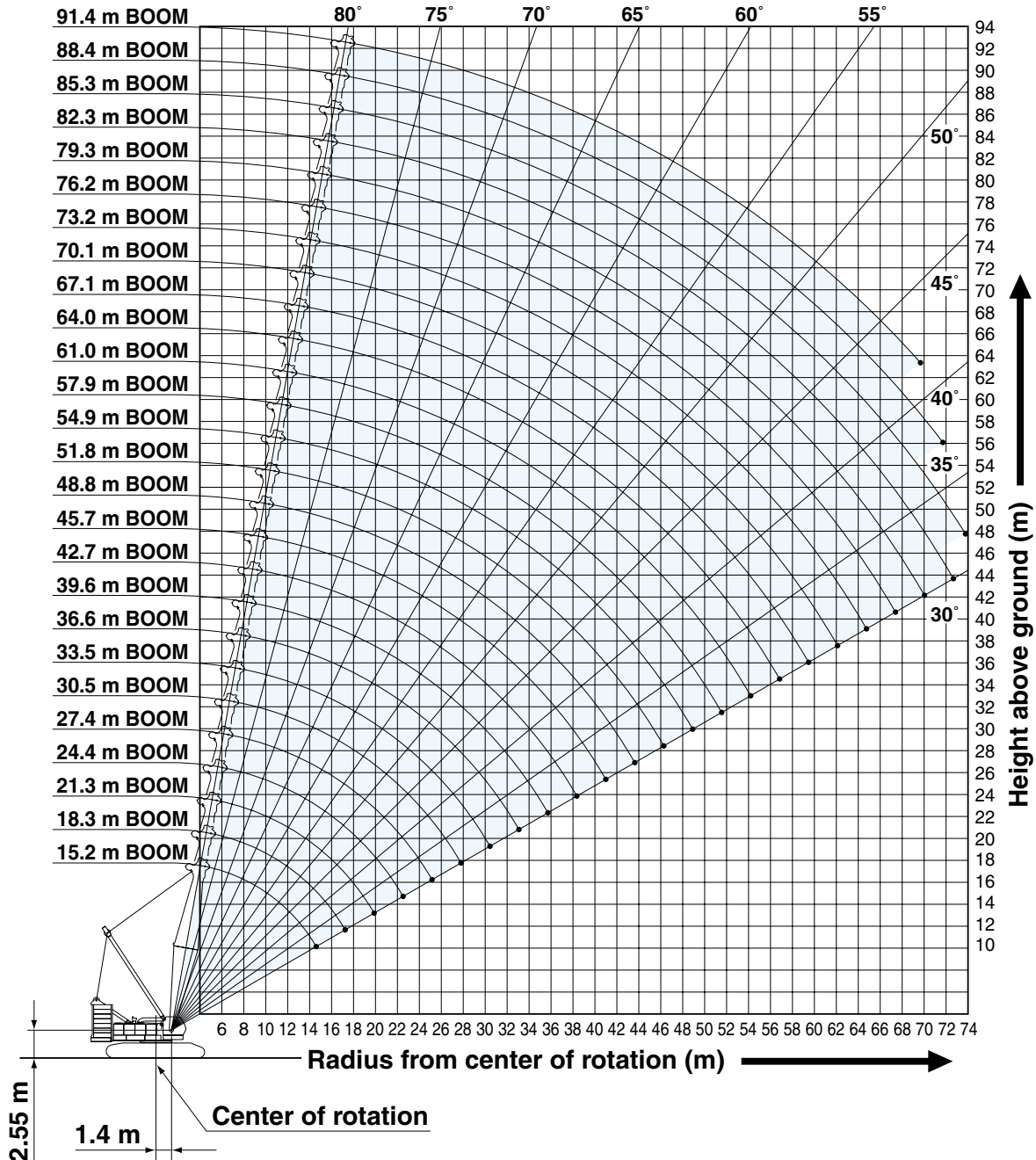

### NOTES:

1. Ratings according to EN13000.
2. Ratings in metric tons for 360° working area.
3. Operating radius is the horizontal distance from center of rotation to a vertical line through the center of gravity of the load.
4. Weight of hook block(s), slings and other load handling accessories is included in rated load. Their total weight must be subtracted from rated load to obtain weight that can be lifted.
5. Ratings shown are based on freely suspended loads and make no allowance for such factors as wind effect on lifted load, ground conditions out-of-level, operating speeds or any other condition that could be detrimental to the safe operation of this equipment. Operator, therefore, has the responsibility to judge the existing conditions and reduce lifted loads and operating speeds accordingly.
6. Ratings are for operation on a firm and level surface, up to 1% gradient.
7. At radii and boom lengths where no ratings are shown on chart, operation is not intended nor approved.
8. Boom inserts and guy lines must be arranged as shown in the "Operator's Manual".
9. Boom hoist reeving is 16 part line.
10. Gantry must be in raised position for all conditions.
11. Boom backstops are required for all boom lengths.
12. The boom should be erected over the front of crawlers, not laterally.
13. Ratings shown in   are determined by the strength of the boom or other structural component.
14. When erecting or lowering the boom length of 88.4 m or over, the pillow plate for erection must be placed at the end of crawlers.
15. Instruction in the "Operator's Manual" must be strictly observed when operating the machine.
16. Crane boom ratings: Deduct weight of hook block, slings, and all other load handling accessories from crane boom ratings shown.
17. Auxiliary sheave ratings for crane boom: Deduct weight of hook block, slings, and all other load handling accessories from auxiliary sheave ratings for crane boom shown.
18. Crane boom lengths for auxiliary sheave mounting are 15.2 m to 88.4 m.



# HYDRAULIC CRAWLER CRANE

## AKL 2600i

### Crane Boom Lifting Capacity

Unit: metric ton

Counterweight: 90.0 t, Carbody weight: 24.0 t

Working radius (m)	Boom Length (m)													Working radius (m)
	15.2	18.3	21.3	24.4	27.4	30.5	33.5	36.6	39.6	42.7	45.7	48.8	51.8	
4.6	4.6 m/260.0													4.6
5.0	230.7	226.7	5.5m/205.0											5.0
6.0	191.5	191.5	191.1	6.1 m/183.0	6.6 m/174.5									6.0
7.0	165.9	165.6	165.2	165.0	164.7	7.1 m/154.2	7.7 m/143.8							7.0
8.0	146.1	145.8	145.4	145.2	144.9	144.6	141.4	8.2 m/127.3	8.7 m/115.7					8.0
9.0	130.4	130.1	129.8	129.6	129.2	127.0	127.3	123.8	114.8	9.2 m/107.2	9.8 m/98.3			9.0
10.0	117.7	117.4	117.1	116.9	114.7	115.0	113.3	110.5	107.4	103.8	97.0	10.3 m/92.6	10.8 m/84.7	10.0
12.0	90.0	90.2	90.2	90.2	90.2	90.1	90.0	89.9	87.8	85.9	83.8	82.0	79.5	12.0
14.0	72.2	72.4	72.4	72.4	72.3	72.2	72.1	72.0	72.0	72.0	70.8	69.4	68.0	14.0
16.0	14.8 m/65.7	60.2	60.2	60.2	60.0	59.9	59.8	59.8	59.7	59.6	59.4	59.3	58.7	16.0
18.0		17.5 m/53.5	51.3	51.3	51.1	51.1	50.9	50.8	50.7	50.7	50.4	50.3	50.2	18.0
20.0			44.6	44.6	44.4	44.3	44.1	44.0	43.9	43.9	43.6	43.5	43.4	20.0
22.0			20.1 m/44.3	39.3	39.1	39.0	38.7	38.7	38.6	38.5	38.3	38.2	38.0	22.0
24.0				22.7 m/37.6	34.8	34.7	34.5	34.4	34.3	34.2	34.0	33.8	33.7	24.0
26.0					25.4 m/32.3	31.3	30.9	30.8	30.7	30.7	30.4	30.3	30.1	26.0
28.0						28.3	28.0	27.9	27.8	27.7	27.4	27.3	27.1	28.0
30.0							25.5	25.4	25.2	25.2	24.9	24.8	24.6	30.0
32.0							30.7 m/24.8	23.4	23.1	23.0	22.7	22.6	22.4	32.0
34.0								33.3 m/22.1	21.2	21.1	20.8	20.7	20.5	34.0
36.0									35.9 m/19.7	19.5	19.2	19.1	18.9	36.0
38.0										18.0	17.7	17.6	17.4	38.0
40.0										38.6 m/17.6	16.4	16.3	16.1	40.0
42.0											41.2 m/15.7	15.2	14.9	42.0
44.0												43.9 m/14.2	13.9	44.0
46.0													13.0	46.0
48.0													46.5 m/12.8	48.0
Reeves	22	18	16	14	14	12	12	10	10	8	8	7	7	Reeves

Working radius (m)	Boom Length (m)													Working radius (m)
	54.9	57.9	61.0	64.0	67.1	70.1	73.2	76.2	79.3	82.3	85.3	88.4	91.4	
10.0	11.4 m/81.4	11.9 m/76.1												10.0
12.0	78.0	75.5	12.4 m/68.8	12.9 m/67.5	13.5 m/63.8									12.0
14.0	66.5	65.2	63.3	62.5	61.3	59.4	14.5 m/54.5	15.1 m/49.1	15.6 m/44.7					14.0
16.0	57.5	56.4	55.4	54.2	53.2	51.2	48.4	44.5	41.1	16.1 m/40.9	16.6 m/37.4	17.2 m/33.8	17.7 m/31.0	16.0
18.0	50.0	49.5	48.6	47.6	46.8	45.6	44.9	44.2	43.2	39.7	36.6	33.3	30.9	18.0
20.0	43.2	43.0	42.9	42.2	41.5	40.6	39.9	39.2	38.4	37.6	35.4	32.2	29.8	20.0
22.0	37.8	37.7	37.5	37.3	37.2	36.5	35.7	35.1	34.4	33.6	32.9	31.2	28.8	22.0
24.0	33.5	33.3	33.2	32.9	32.9	32.6	32.2	31.6	30.9	30.2	29.6	29.2	27.7	24.0
26.0	29.9	29.7	29.6	29.4	29.3	29.0	28.9	28.6	28.0	27.3	26.8	26.3	25.7	26.0
28.0	26.9	26.8	26.6	26.4	26.3	26.0	25.9	25.8	25.4	24.8	24.3	23.9	23.3	28.0
30.0	24.4	24.2	24.1	23.8	23.7	23.5	23.3	23.2	23.0	22.6	22.1	21.7	21.2	30.0
32.0	22.2	22.0	21.9	21.6	21.5	21.3	21.1	21.0	20.8	20.5	20.2	19.8	19.3	32.0
34.0	20.3	20.1	20.0	19.7	19.6	19.4	19.2	19.1	18.9	18.6	18.4	18.1	17.6	34.0
36.0	18.6	18.5	18.3	18.1	17.9	17.7	17.5	17.4	17.2	16.9	16.8	16.6	16.1	36.0
38.0	17.2	17.0	16.9	16.6	16.5	16.2	16.0	15.9	15.7	15.4	15.3	15.2	14.7	38.0
40.0	15.9	15.7	15.5	15.3	15.2	14.9	14.7	14.6	14.4	14.1	13.9	13.8	13.5	40.0
42.0	14.7	14.5	14.4	14.1	14.0	13.7	13.5	13.4	13.2	12.9	12.8	12.7	12.4	42.0
44.0	13.7	13.5	13.3	13.0	12.9	12.6	12.5	12.3	12.1	11.8	11.7	11.6	11.3	44.0
46.0	12.7	12.5	12.4	12.1	12.0	11.7	11.5	11.4	11.2	10.9	10.7	10.6	10.4	46.0
48.0	11.9	11.6	11.5	11.2	11.1	10.8	10.7	10.5	10.3	10.0	9.8	9.7	9.4	48.0
50.0	49.1 m/11.4	10.9	10.7	10.4	10.3	10.0	9.9	9.7	9.5	9.1	8.9	8.8	8.5	50.0
52.0		51.8 m/10.2	10.0	9.7	9.6	9.3	9.1	8.9	8.7	8.3	8.1	8.0	7.7	52.0
54.0			9.3	9.1	8.9	8.6	8.4	8.2	7.9	7.6	7.4	7.2	7.0	54.0
56.0			54.4 m/9.2	8.4	8.3	7.9	7.7	7.5	7.2	6.9	6.7	6.5	6.3	56.0
58.0				57.1 m/8.1	7.7	7.3	7.1	6.9	6.6	6.3	6.1	5.9	5.6	58.0
60.0					59.7 m/7.2	6.7	6.5	6.3	6.0	5.7	5.5	5.3	5.0	60.0
62.0						6.2	6.0	5.8	5.5	5.1	4.9	4.8	4.5	62.0
64.0						62.3 m/6.1	5.5	5.3	5.0	4.6	4.4	4.3	4.0	64.0
66.0							65.0 m/5.3	4.8	4.5	4.2	4.0	3.8	3.5	66.0
68.0								67.6 m/4.5	4.1	3.7	3.5	3.3	2.9	68.0
70.0									3.7	3.3	3.1	2.9	2.4	70.0
72.0									70.2 m/3.6	2.9	2.7	2.5		72.0
74.0										72.9 m/2.8	2.4			74.0
Reeves	7	6	6	5	5	5	5	4	4	4	3	3	3	Reeves

Note: Ratings according to EN13000.

Ratings shown in   are determined by the strength of the boom or other structural components.

Refer to notes P12.



# Auxiliary Sheave Lifting Capacity for Crane Boom (With 70 t Main Hook)

Unit: metric ton

Counterweight: 90.0 t, Carbody weight: 24.0 t

Working radius (m)	Boom Length (m)													Working radius (m)
	15.2	18.3	21.3	24.4	27.4	30.5	33.5	36.6	39.6	42.7	45.7	48.8	51.8	
5.0	5.4 m/27.0	5.8 m/27.0												5.0
6.0	27.0	27.0	6.3 m/27.0	6.9 m/27.0										6.0
7.0	27.0	27.0	27.0	27.0	7.4 m/27.0	7.9 m/27.0								7.0
8.0	27.0	27.0	27.0	27.0	27.0	27.0	8.5 m/27.0							8.0
9.0	27.0	27.0	27.0	27.0	27.0	27.0	27.0	27.0	9.5 m/27.0					9.0
10.0	27.0	27.0	27.0	27.0	27.0	27.0	27.0	27.0	27.0	10.6 m/27.0	11.1 m/27.0	11.6 m/27.0		10.0
12.0	27.0	27.0	27.0	27.0	27.0	27.0	27.0	27.0	27.0	27.0	27.0	27.0	27.0	12.0
14.0	27.0	27.0	27.0	27.0	27.0	27.0	27.0	27.0	27.0	27.0	27.0	27.0	27.0	14.0
16.0	27.0	27.0	27.0	27.0	27.0	27.0	27.0	27.0	27.0	27.0	27.0	27.0	27.0	16.0
18.0	16.5 m/27.0	19.2 m/27.0	27.0	27.0	27.0	27.0	27.0	27.0	27.0	27.0	27.0	27.0	27.0	18.0
20.0			27.0	27.0	27.0	27.0	27.0	27.0	27.0	27.0	27.0	27.0	27.0	20.0
22.0			21.8 m/27.0	27.0	27.0	27.0	27.0	27.0	27.0	27.0	27.0	27.0	27.0	22.0
24.0				27.0	27.0	27.0	27.0	27.0	27.0	27.0	27.0	27.0	27.0	24.0
26.0				24.4 m/27.0	27.0	27.0	27.0	27.0	27.0	27.0	27.0	27.0	27.0	26.0
28.0					27.1 m/26.6	26.4	26.5	26.4	26.3	26.2	25.9	25.8	25.6	28.0
30.0						29.7 m/23.5	24.0	23.9	23.7	23.7	23.4	23.3	23.1	30.0
32.0							32.4 m/21.0	21.9	21.6	21.5	21.2	21.1	20.9	32.0
34.0								19.9	19.7	19.6	19.3	19.2	19.0	34.0
36.0								35.0 m/18.9	17.8	18.0	17.7	17.6	17.4	36.0
38.0									37.6 m/16.3	16.5	16.2	16.1	15.9	38.0
40.0										15.0	14.9	14.8	14.6	40.0
42.0										40.3 m/14.8	13.6	13.7	13.4	42.0
44.0											42.9 m/13.0	12.6	12.4	44.0
46.0												45.6 m/11.7	11.5	46.0
48.0													10.6	48.0
50.0													48.2 m/10.5	50.0
Reeves	2	2	2	2	2	2	2	2	2	2	2	2	2	Reeves

Working radius (m)	Boom Length (m)												Working radius (m)
	54.9	57.9	61.0	64.0	67.1	70.1	73.2	76.2	79.3	82.3	85.3	88.4	
12.0	12.2 m/27.0	12.7 m/27.0	13.2 m/27.0	13.7 m/27.0									12.0
14.0	27.0	27.0	27.0	27.0	14.3 m/27.0	14.8 m/27.0	15.3 m/27.0	15.9 m/27.0					14.0
16.0	27.0	27.0	27.0	27.0	27.0	27.0	27.0	27.0	16.4 m/27.0	16.9 m/27.0	17.4 m/27.0		16.0
18.0	27.0	27.0	27.0	27.0	27.0	27.0	27.0	27.0	27.0	27.0	27.0	27.0	18.0
20.0	27.0	27.0	27.0	27.0	27.0	27.0	27.0	27.0	27.0	27.0	27.0	27.0	20.0
22.0	27.0	27.0	27.0	27.0	27.0	27.0	27.0	27.0	27.0	27.0	27.0	27.0	22.0
24.0	27.0	27.0	27.0	27.0	27.0	27.0	27.0	27.0	27.0	27.0	27.0	27.0	24.0
26.0	27.0	27.0	27.0	27.0	27.0	27.0	27.0	27.0	26.5	25.8	25.3	24.8	26.0
28.0	25.4	25.3	25.1	24.9	24.8	24.5	24.4	24.3	23.9	23.3	22.8	22.4	28.0
30.0	22.9	22.7	22.6	22.3	22.2	22.0	21.8	21.7	21.5	21.1	20.6	20.2	30.0
32.0	20.7	20.5	20.4	20.1	20.0	19.8	19.6	19.5	19.3	19.0	18.7	18.3	32.0
34.0	18.8	18.6	18.5	18.2	18.1	17.9	17.7	17.6	17.4	17.1	16.9	16.6	34.0
36.0	17.1	17.0	16.8	16.6	16.4	16.2	16.0	15.9	15.7	15.4	15.3	15.1	36.0
38.0	15.7	15.5	15.4	15.1	15.0	14.7	14.5	14.4	14.2	13.9	13.8	13.7	38.0
40.0	14.4	14.2	14.0	13.8	13.7	13.4	13.2	13.1	12.9	12.6	12.4	12.3	40.0
42.0	13.2	13.0	12.9	12.6	12.5	12.2	12.0	11.9	11.7	11.4	11.3	11.2	42.0
44.0	12.2	12.0	11.8	11.5	11.4	11.1	11.0	10.8	10.6	10.3	10.2	10.1	44.0
46.0	11.2	11.0	10.9	10.6	10.5	10.2	10.0	9.9	9.7	9.4	9.2	9.1	46.0
48.0	10.4	10.1	10.0	9.7	9.6	9.3	9.2	9.0	8.8	8.5	8.3	8.2	48.0
50.0	9.6	9.4	9.2	8.9	8.8	8.5	8.4	8.2	8.0	7.6	7.4	7.3	50.0
52.0	50.8 m/9.3	8.7	8.5	8.2	8.1	7.8	7.6	7.4	7.2	6.8	6.6	6.5	52.0
54.0		53.5 m/8.2	7.8	7.6	7.4	7.1	6.9	6.7	6.4	6.1	5.9	5.7	54.0
56.0			7.1	6.9	6.8	6.4	6.2	6.0	5.7	5.4	5.2	5.0	56.0
58.0			56.1 m/7.1	6.2	6.2	5.8	5.6	5.4	5.1	4.8	4.6	4.4	58.0
60.0				58.8 m/5.9	5.6	5.2	5.0	4.8	4.5	4.2	4.0	3.8	60.0
62.0					61.4 m/5.2	4.7	4.5	4.3	4.0	3.6	3.4	3.3	62.0
64.0						4.2	4.0	3.8	3.5	3.1	2.9	2.8	64.0
66.0							3.5	3.3	3.0	2.7	2.5		66.0
68.0							66.7 m/3.3	2.8	2.6				68.0
70.0								69.3 m/2.5					70.0
Reeves	2	2	2	2	2	2	2	2	2	2	2	2	Reeves

Note: Ratings according to EN13000.

Ratings shown in   are determined by the strength of the boom or other structural components.

Refer to notes P12.

## Fixed Jib Working Ranges

Jib Offset Angle: 10°, 30°

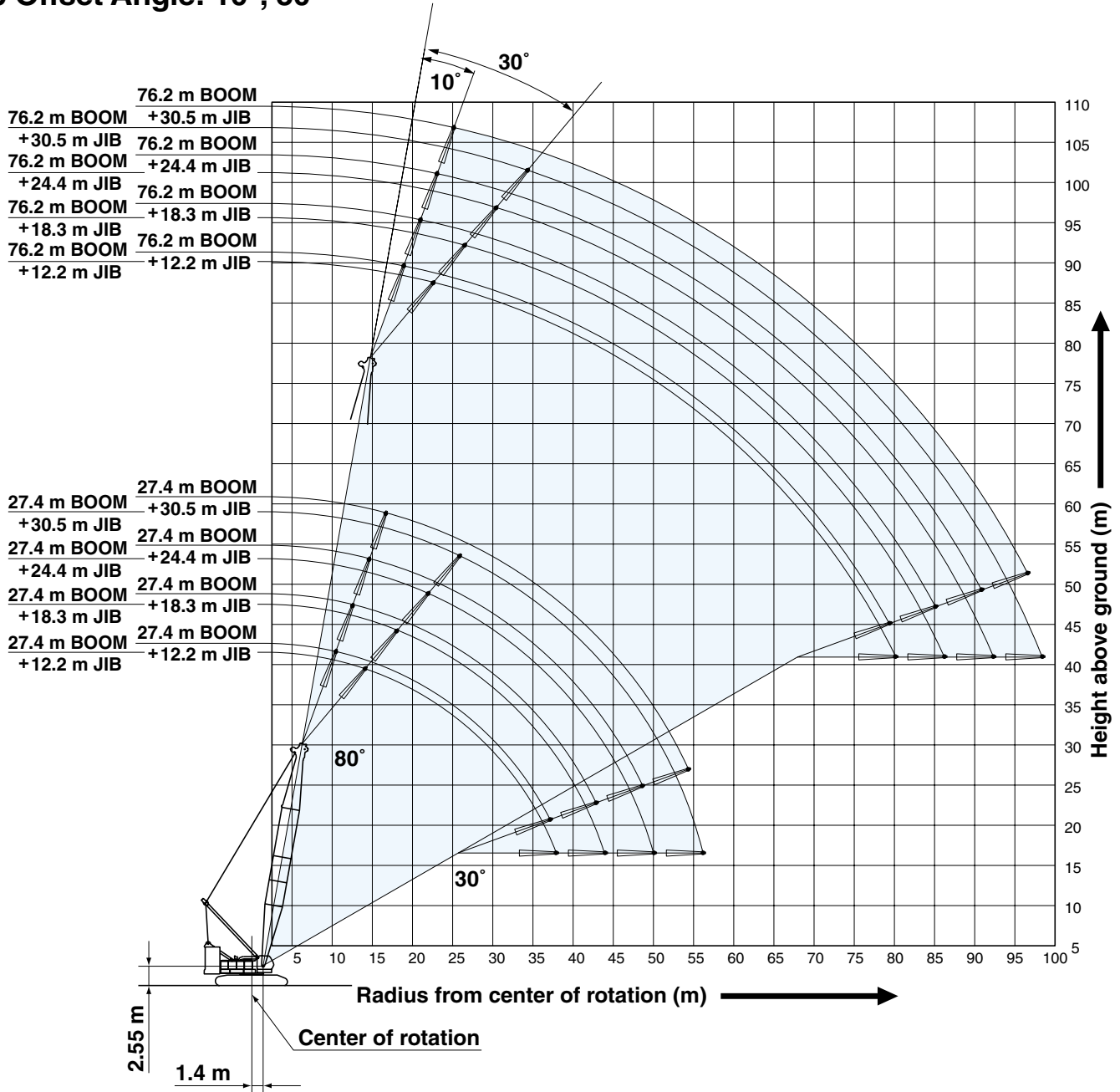

### NOTES:

- Ratings according to EN13000.
- Ratings in metric tons for 360° working area.
- Operating radius is the horizontal distance from center of rotation to a vertical line through the center of gravity of the load.
- Weight of hook block(s), slings and other load handling accessories is included in rated load. Their total weight must be subtracted from rated load to obtain weight that can be lifted.
- Ratings shown are based on freely suspended loads and make no allowance for such factors as wind effect on lifted load, ground conditions out-of-level, operating speeds or any other condition that could be detrimental to the safe operation of this equipment. Operator, therefore, has the responsibility to judge the existing conditions and reduce lifted loads and operating speeds accordingly.
- Ratings are for operation on a firm and level surface, up to 1% gradient.
- At radii and boom lengths where no ratings are shown on chart, operation is not intended nor approved.
- Boom/ jib inserts and guy lines must be arranged as shown in the "Operator's Manual".
- Boom hoist reeving is 16 part line.
- Gantry must be in raised position for all conditions.
- Boom backstops are required for all boom lengths.
- The boom should be erected over the front of crawlers, not laterally.
- Ratings shown in   are determined by the strength of the boom or other structural component.
- When erecting or lowering the boom length of 76.2 m, the pillow plate for erection must be placed at the end of crawlers.
- Instruction in the "Operator's Manual" must be strictly observed when operating the machine.
- Fixed jib ratings: Deduct weight of jib hook block, slings, and all other load handling accessories from fixed jib ratings shown.
- Crane boom lengths for fixed jib mounting are 27.4 m to 76.2 m.
- One part of line on hook is not allowed to use for 12.2 m jib length with offset angle 10 degrees.



# Fixed Jib Lifting Capacities (Without Main Hook)

Unit: metric ton

Jib Offset Angle: 10°

Counterweight: 90.0 t, Carbody weight: 24.0 t

Boom length (m)		27.4				36.6				45.7				54.9				Boom length (m)
Jib length (m)		12.2	18.3	24.4	30.5	12.2	18.3	24.4	30.5	12.2	18.3	24.4	30.5	12.2	18.3	24.4	30.5	Jib length (m)
Working radius (m)	10.0	10.4 m/27.0																10.0
	12.0	25.5	12.5 m/21.2			26.6				13.6 m/26.5								12.0
	14.0	24.3	20.4	14.6 m/12.1		25.5	14.1 m/21.2			26.3	15.7 m/21.2			15.2 m/26.4				14.0
	16.0	23.0	19.3	11.8	16.7 m/6.8	24.5	20.3	16.2 m/12.1		25.4	21.0	17.8 m/12.1		26.2	17.3 m/21.1			16.0
	18.0	21.8	18.4	11.2	6.5	23.6	19.4	11.7	18.3 m/6.8	24.6	20.2	12.1	19.9 m/6.7	25.4	20.9	19.4 m/12.1		18.0
	20.0	20.7	17.5	10.7	6.2	22.7	18.6	11.2	6.5	23.8	19.5	11.6	6.7	24.7	20.2	12.0	21.5 m/6.8	20.0
	22.0	19.8	16.8	10.3	5.9	21.9	17.9	10.8	6.2	23.0	18.8	11.3	6.4	23.9	19.5	11.6	6.7	22.0
	24.0	18.9	16.1	9.9	5.6	21.2	17.2	10.4	5.9	22.2	18.1	10.9	6.2	23.2	18.9	11.3	6.4	24.0
	26.0	18.1	15.4	9.4	5.3	20.5	16.6	10.1	5.7	21.5	17.5	10.5	5.9	22.5	18.3	10.9	6.2	26.0
	28.0	17.3	14.3	9.1	5.1	19.8	16.1	9.7	5.4	20.7	17.0	10.2	5.7	21.9	17.8	10.6	6.0	28.0
	30.0	16.7	13.4	8.7	4.9	19.1	15.5	9.4	5.2	20.0	16.5	9.9	5.5	21.3	17.3	10.3	5.8	30.0
	34.0	15.5	11.9	8.1	4.5	17.8	13.8	8.7	4.8	18.6	15.6	9.3	5.1	20.1	16.4	9.8	5.4	34.0
	38.0	37.1 m/14.5	10.7	7.6	4.2	16.4	12.4	8.2	4.5	17.1	14.0	8.8	4.8	17.4	15.6	9.2	5.1	38.0
	42.0		9.8	7.1	3.9	15.3	11.3	7.7	4.2	15.5	12.8	8.3	4.5	14.9	14.2	8.8	4.8	42.0
	46.0		42.9 m/9.7	6.8	3.7	45.1 m/14.4	10.5	7.3	4.0	13.6	11.8	7.9	4.2	12.8	13.1	8.3	4.5	46.0
	50.0			48.6 m/6.6	3.5		9.8	7.0	3.8	11.9	11.0	7.5	4.0	11.1	11.6	8.0	4.3	50.0
	54.0				3.2		50.8 m/9.6	6.7	3.6	53.0 m/10.9	10.3	7.2	3.8	9.7	10.1	7.6	4.1	54.0
	58.0				54.3 m/3.1			56.5 m/6.5	3.4		9.7	6.9	3.7	8.5	8.9	7.3	3.9	58.0
	62.0								3.2		58.7 m/9.6	6.7	3.5	60.9 m/7.8	7.8	7.1	3.7	62.0
	66.0								62.3 m/3.1			64.4 m/6.5	3.4		6.9	6.8	3.6	66.0
70.0												3.1		66.6 m/6.8	6.5	3.5	70.0	
74.0													70.2 m/3.1		72.4 m/6.1	3.4	74.0	
78.0																3.2	78.0	
82.0																78.1 m/3.2	82.0	
Reeves	2	2	1	1	2	2	1	1	2	2	1	1	2	2	1	1	Reeves	

Boom length (m)		64.0				73.2				76.2				Boom length (m)
Jib length (m)		12.2	18.3	24.4	30.5	12.2	18.3	24.4	30.5	12.2	18.3	24.4	30.5	Jib length (m)
Working radius (m)	16.0	16.8 m/26.5												16.0
	18.0	26.0	18.9 m/21.1			18.4 m/26.4				18.9 m/26.4				18.0
	20.0	25.3	20.7	21.0 m/12.1		25.9	20.5 m/21.1			26.1	21.0 m/21.1			20.0
	22.0	24.7	20.1	11.9	23.0 m/6.7	25.3	20.6	22.5 m/12.1		25.5	20.8	23.1 m/12.0		22.0
	24.0	24.1	19.5	11.6	6.6	24.7	20.0	11.8	24.6 m/6.7	24.9	20.2	11.9	25.2 m/6.7	24.0
	26.0	23.5	19.0	11.3	6.4	24.2	19.5	11.5	6.5	24.4	19.7	11.6	6.6	26.0
	28.0	23.0	18.4	11.0	6.2	23.7	19.0	11.2	6.3	23.9	19.2	11.3	6.4	28.0
	30.0	22.4	18.0	10.7	6.0	22.6	18.5	11.0	6.2	21.7	18.7	11.1	6.2	30.0
	34.0	19.8	17.1	10.2	5.6	18.9	17.7	10.5	5.8	18.3	17.9	10.6	5.9	34.0
	38.0	16.6	16.3	9.7	5.3	15.8	16.3	10.0	5.5	15.5	15.9	10.1	5.6	38.0
	42.0	14.1	14.5	9.2	5.0	13.3	13.8	9.6	5.2	13.0	13.5	9.7	5.3	42.0
	46.0	12.0	12.5	8.8	4.7	11.2	11.7	9.2	4.9	10.9	11.4	9.3	5.0	46.0
	50.0	10.3	10.7	8.4	4.5	9.5	10.0	8.8	4.7	9.2	9.7	8.9	4.8	50.0
	54.0	8.9	9.3	8.0	4.3	8.1	8.5	8.4	4.5	7.8	8.2	8.5	4.5	54.0
	58.0	7.7	8.1	7.7	4.1	6.9	7.3	7.8	4.3	6.5	7.0	7.6	4.4	58.0
	62.0	6.6	7.0	7.5	3.9	5.8	6.2	6.8	4.1	5.5	5.9	6.5	4.2	62.0
	66.0	5.7	6.1	6.6	3.8	4.9	5.3	5.8	4.0	4.6	5.0	5.5	4.0	66.0
	70.0	68.8 m/5.1	5.3	5.7	3.6	4.1	4.5	5.0	3.8	3.7	4.1	4.7	3.9	70.0
	74.0		4.6	5.0	3.5	3.4	3.7	4.3	3.7	3.0	3.4	4.0	3.7	74.0
	78.0		74.6 m/4.5	4.3	3.4	76.7 m/2.9	3.1	3.6	3.6	2.4	2.8	3.3	3.5	78.0
82.0			80.3 m/4.0	3.4		2.5	3.0	3.3	79.4 m/2.2	2.2	2.7	3.0	82.0	
86.0				3.2		82.5 m/2.5	2.5	2.7		85.1 m/1.8	2.2	2.5	86.0	
90.0							88.2 m/2.2	2.1			1.7	2.0	90.0	
94.0								93.9 m/1.8			90.8 m/1.5	1.6	94.0	
98.0											96.6 m/1.3		98.0	
Reeves	2	2	1	1	2	2	1	1	2	2	1	1	Reeves	

Note: Ratings according to EN13000.  
 Ratings shown in   are determined by the strength of the boom or other structural components.  
 Refer to notes P21.  
 \*One part of line on hook is not allowed to use for 12.2 m jib length with offset angle 10 degrees.

# HYDRAULIC CRAWLER CRANE CKL 2600i

Unit: metric ton

**Jib Offset Angle: 30°**

**Counterweight: 90.0 t, Carbody weight: 24.0 t**

Boom length (m)		27.4				36.6				45.7				54.9				Boom length (m)
Jib length (m)		12.2	18.3	24.4	30.5	12.2	18.3	24.4	30.5	12.2	18.3	24.4	30.5	12.2	18.3	24.4	30.5	Jib length (m)
Working radius (m)	14.0	14.1 m/19.3				15.7 m/19.3												14.0
	16.0	18.7				19.2				17.3 m/19.2								16.0
	18.0	17.9	13.5			18.7	19.6 m/13.5			19.1				18.9 m/19.2				18.0
	20.0	16.8	13.5	21.9 m/8.2		18.1	13.5			18.7	21.2 m/13.5			19.0				20.0
	22.0	15.9	13.1	8.2		17.2	13.5	23.5 m/8.1		18.2	13.5			18.6	22.8 m/13.5			22.0
	24.0	15.2	12.6	7.9	25.9 m/4.4	16.4	13.1	8.1		17.4	13.4	25.1 m/8.1		18.2	13.5			24.0
	26.0	14.5	12.0	7.6	4.4	15.7	12.8	7.9	27.5 m/4.3	16.7	13.2	8.0		17.6	13.4	26.7 m/8.1		26.0
	28.0	13.9	11.4	7.4	4.2	15.1	12.3	7.6	4.3	16.1	12.9	7.8	29.0 m/4.4	17.0	13.2	8.0		28.0
	30.0	13.4	10.9	7.2	4.1	14.6	11.8	7.4	4.2	15.6	12.5	7.6	4.3	16.4	12.9	7.8	30.6 m/4.3	30.0
	34.0	12.7	10.0	6.8	3.8	13.7	10.9	7.1	4.0	14.6	11.6	7.3	4.1	15.5	12.2	7.5	4.2	34.0
	38.0	37.9 m/12.4	9.4	6.5	3.7	13.0	10.2	6.8	3.8	13.9	10.9	7.0	3.9	14.7	11.5	7.2	4.0	38.0
	42.0		9.0	6.2	3.5	12.6	9.6	6.5	3.6	13.3	10.3	6.7	3.7	14.0	10.9	6.9	3.8	42.0
	46.0		44.0 m/8.9	6.1	3.3	45.8 m/12.4	9.2	6.3	3.5	12.8	9.8	6.5	3.6	13.2	10.4	6.7	3.7	46.0
	50.0			6.1	3.3		8.9	6.1	3.4	12.1	9.4	6.3	3.5	11.4	9.9	6.5	3.6	50.0
	54.0			50.1 m/6.1	3.0		51.9 m/8.9	6.1	3.3	53.7 m/10.7	9.1	6.2	3.4	9.9	9.5	6.4	3.5	54.0
	58.0				56.2 m/2.8			6.1	3.1		8.9	6.1	3.3	8.6	9.2	6.2	3.4	58.0
	62.0								2.9		59.8 m/8.9	6.1	3.3	61.6 m/7.6	8.2	6.1	3.3	62.0
	66.0								64.1 m/2.8			65.9 m/6.1	3.1		7.2	6.0	3.2	66.0
	70.0												2.9		67.7 m/6.8	6.0	3.2	70.0
	74.0													72.0 m/2.8		73.8 m/6.0	3.1	74.0
78.0																2.9	78.0	
82.0																79.9 m/2.8	82.0	
Reeves	2	1	1	1	2	1	1	1	2	1	1	1	2	1	1	1	Reeves	

Boom length (m)		64.0				73.2				76.2				Boom length (m)
Jib length (m)		12.2	18.3	24.4	30.5	12.2	18.3	24.4	30.5	12.2	18.3	24.4	30.5	Jib length (m)
Working radius (m)	20.0	20.5 m/19.2												20.0
	22.0	18.9				19.1				22.6 m/19.1				22.0
	24.0	18.6	24.4 m/13.5			18.8				18.9				24.0
	26.0	18.3	13.5			18.6	13.5			18.7	26.5 m/13.5			26.0
	28.0	17.7	13.4	28.3 m/8.1		18.3	13.5	29.9 m/8.1		18.4	13.5			28.0
	30.0	17.2	13.2	7.9	32.2 m/4.3	17.8	13.4	8.0	33.8 m/4.3	18.0	13.4	30.4 m/8.0		30.0
	34.0	16.2	12.8	7.6	4.2	16.8	13.0	7.8	4.3	17.0	13.1	7.8	34.3 m/4.3	34.0
	38.0	15.4	12.0	7.4	4.1	16.0	12.5	7.5	4.1	16.2	12.7	7.5	4.2	38.0
	42.0	14.6	11.4	7.1	3.9	13.9	11.9	7.3	4.0	13.6	12.0	7.3	4.0	42.0
	46.0	12.4	10.9	6.9	3.8	11.7	11.3	7.1	3.8	11.5	11.5	7.1	3.9	46.0
	50.0	10.7	10.4	6.7	3.7	10.0	10.9	6.9	3.7	9.7	10.6	6.9	3.8	50.0
	54.0	9.2	10.0	6.5	3.6	8.5	9.3	6.7	3.6	8.2	9.1	6.7	3.7	54.0
	58.0	7.9	8.7	6.4	3.4	7.2	8.0	6.5	3.5	6.9	7.7	6.6	3.5	58.0
	62.0	6.8	7.5	6.3	3.4	6.1	6.9	6.4	3.4	5.8	6.6	6.4	3.5	62.0
	66.0	5.8	6.5	6.1	3.3	5.1	5.8	6.3	3.4	4.8	5.6	6.1	3.4	66.0
	70.0	69.6 m/5.1	5.6	6.1	3.3	4.2	5.0	5.5	3.3	3.9	4.7	5.2	3.3	70.0
	74.0		4.8	5.3	3.2	3.4	4.2	4.7	3.3	3.2	3.9	4.4	3.3	74.0
	78.0		75.7 m/4.5	4.6	3.2	77.5 m/2.9	3.4	3.9	3.2	2.5	3.2	3.7	3.2	78.0
	82.0			81.8 m/3.9	3.0		2.8	3.3	3.2	80.1 m/2.2	2.5	3.0	3.2	82.0
	86.0				2.9		83.6 m/2.5	2.7	2.9		1.9	2.4	2.8	86.0
90.0				87.8 m/2.8			89.7 m/2.1	2.5		86.2 m/1.9	1.8	2.3	90.0	
94.0								2.0			92.3 m/1.5	1.8	94.0	
98.0								95.8 m/1.7				1.4	98.0	
100.0												98.4 m/1.3	100.0	
Reeves	2	1	1	1	2	1	1	1	2	1	1	1	Reeves	

Note: Ratings according to EN13000.  
Ratings shown in   are determined by the strength of the boom or other structural components.  
Refer to notes P21.

# PARTS AND ATTACHMENTS

Dimensions: mm Weight: kg

## Base Machine

With trans-lifter, main and aux. winches (non-free fall) including wire rope and boom hoist winch including wire rope  
Weight: 46,000 kg Width: 3,400 mm

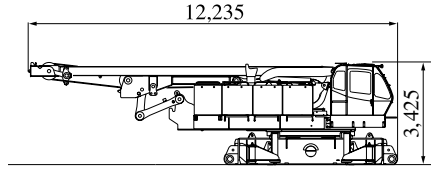

## Crawler

Weight: 20,700 kg

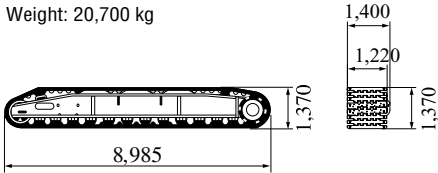

## Mast

Weight: 2,870 kg

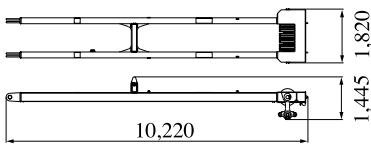

## Gantry

Weight: 3,020 kg

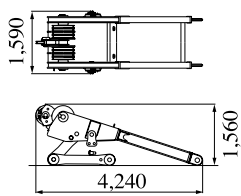

## Translifter

Weight: 395 kg

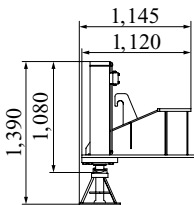

## Boom Base

Weight: 4,665 kg

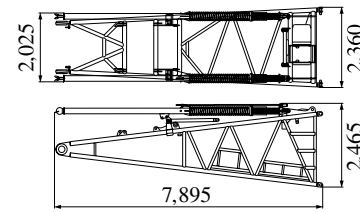

## 3.0 m Insert Boom (with Guy Line)

Weight: 890 kg

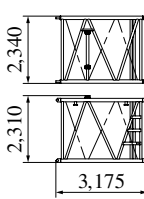

## 6.1 m Insert Boom (with Guy Line)

Weight: 1,440 kg

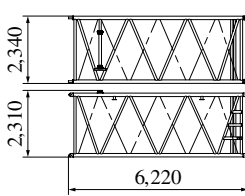

## Jib Base (Fixed Jib)

Weight: 210 kg

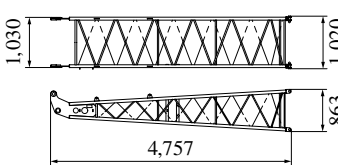

## Boom Base (with Winch)

Weight: 6,810 kg

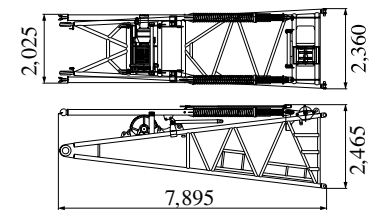

## Boom Top

Weight: 3,740 kg (with boom guy cables)

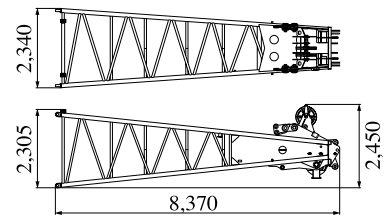

## 12.2 m Insert Boom (with Guy Line)

Weight: 2,540 kg

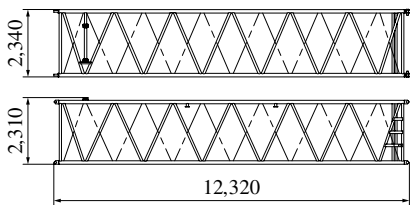

## Jib Strut (Fixed Jib)

Weight: 300 kg

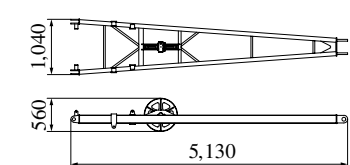

## Counterweight (A) with Hanger

Weight: 11,040 kg

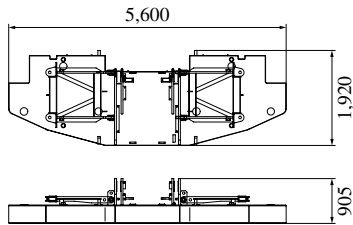

## Counterweight (B)

Weight: 5,685 kg / 1 Piece

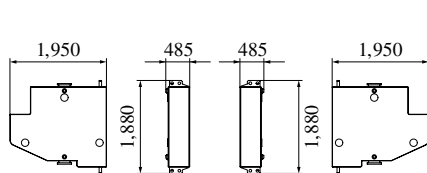

## Counterweight Assy

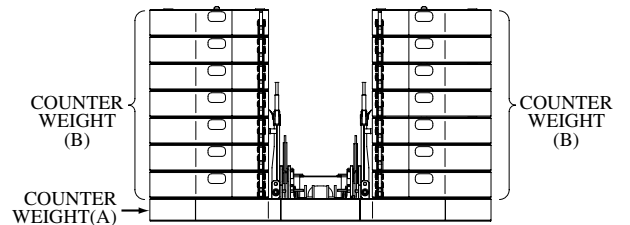

## Carbody Weight (Base) (with Link)

Weight: 6,350 kg x 1 piece

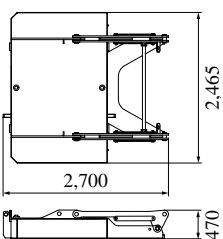

## Carbody Weight (B)

Weight: 5,625 kg

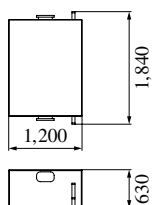

## Carbody Weight Assy

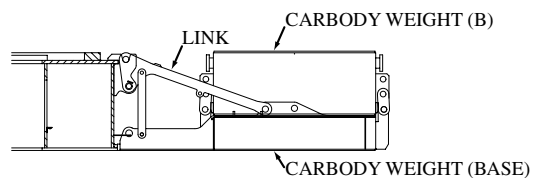



# HYDRAULIC CRAWLER CRANE GKL 2600i

Dimensions: mm Weight: kg

**Jib Top (For Crane)**

Weight: 315 kg

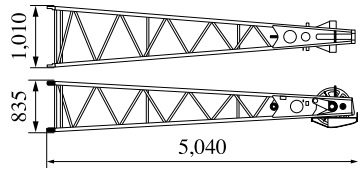

**Aux. Sheave**

Weight: 290 kg

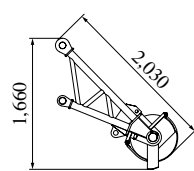

**3.0 m**

**Insert Jib (Fixed Jib)**

Weight: 110 kg

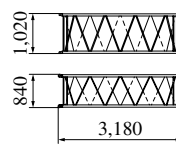

**6.1 m**

**Insert Jib (Fixed Jib)**

Weight: 190 kg

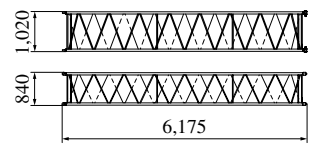

**Ball Hook**

Weight: 455 kg

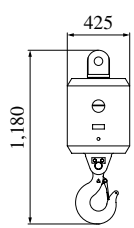

**35 t Hook**

Weight: 900 kg

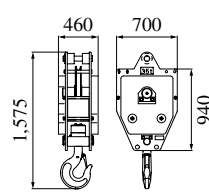

**70 t Hook**

Weight: 1,200 kg

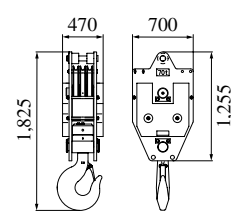

**100 t Hook**

Weight: 1,800 kg

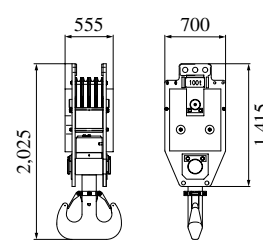

**150 t Hook**

Weight: 2,300 kg

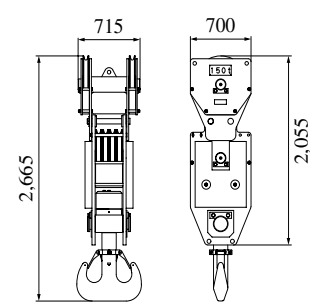

**260 t Hook**

Weight: 4,160 kg

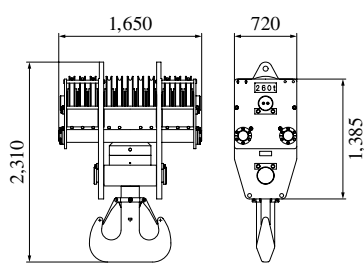

# SELF-REMOVAL DEVICE

1

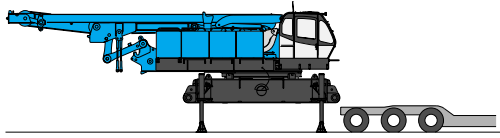

2

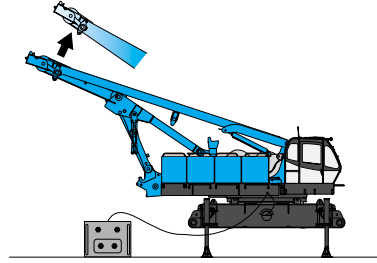

3

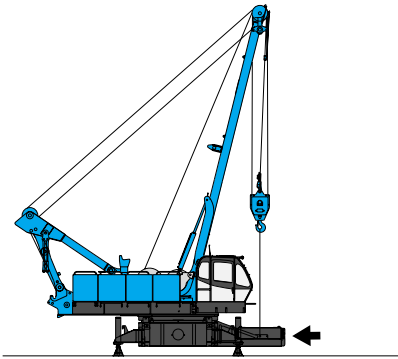

4

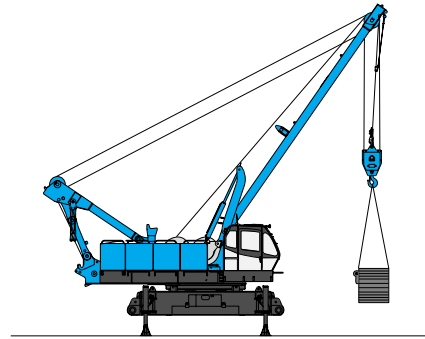

5

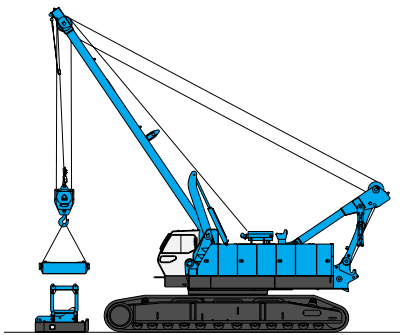

6

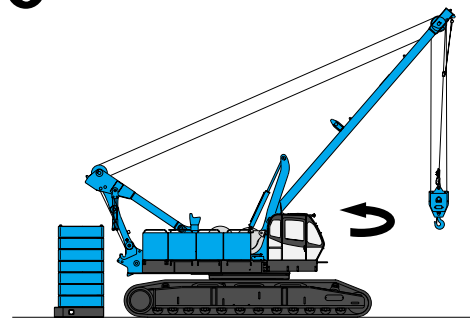

7

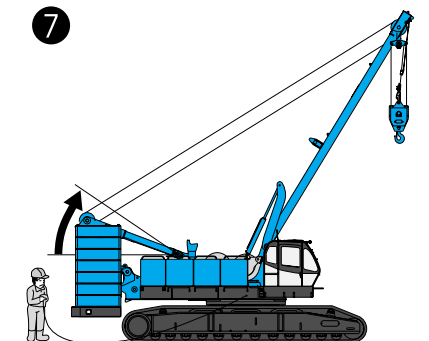

8

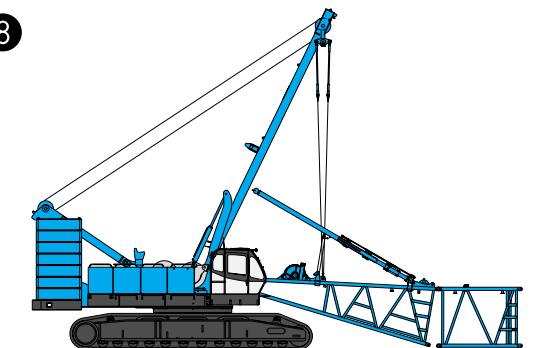





**HYDRAULIC CRAWLER CRANE**  
**CKL2600i**

**Standard Equipment**

**Upper structure/Lower structure**

- Counterweight: 90.0 t (total weight)
- Carbody weight: 24.0 t (total weight)
- 1,220 mm shoe crawlers
- Batteries (150Ah/20HR)
- Trans-lifter (jack system)
- Gantry raising/lowering cylinder
- Electric hand throttle grip
- Variable boom hoist speed controller
- Variable main/aux. hoist speed controller
- Swing neutral-free/brake select switch
- Side deck for cab
- Side deck (right side guard)
- Steps (crawlers)
- Two front working lights
- Tools (for routine maintenance)
- Two rear view mirrors
- Electric fuel pump
- Counterweight self removal
- Crawler self removal
- Base boom self removal
- Cable roller (for boom)

**Cab/Control**

- Air conditioner
- Cup holder
- Ashtray
- Cigar lighter
- Intermittent wiper & window washer (skylight and front window)
- Sun visor
- Roof blind
- Floor mat (cloth)
- Foot rest
- Shoe tray

**Safety Device**

- Load Moment Indicator (with boom lowering slow stop function)
- LMI release key (for hook over-hoist prevention device and boom over-hoist prevention device)
- LCD multi display
- Ultimate stop function for boom over-hoist
- Function lock lever
- Propel lever lock
- Mechanical drum lock pawl (main, aux. and boom hoist)
- Signal horn
- Swing parking brake
- Mechanical swing lock pin (four positions)
- Swing flashers/warning buzzer
- External lamp for over-load alarm

**Note:** Standard equipment may vary depending on your areas or countries.

Due to our policy of continual product improvements all designs and specifications are subject to change without advance notice.

Copyright by KOBELCO CRANES CO., LTD. No part of this catalog may be reproduced in any manner without notice.

**KOBELCO CRANES INDIA PVT. LTD.**

Third Floor, Mother House, Plot No. 22,  
 Gulmohar Enclave Community Center, Yusuf Sarai, New Delhi - 110 049, India  
 Tel: +91-11-30151950 Fax: +91-11-30151952

Inquiries To:

**KOBELCO** is the corporate mark used by Kobe Steel on a variety of products and in the names of a number of Kobe Steel Group companies.