

New Dimensions  
in Motion

**SPECIFICATIONS**

 **HITACHI**

# **KH100D**

**HYDRAULIC CRAWLER DRAGLINE**

**CLAMSHELL, CRANE**

Dragline Bucket Capacity ... 1.0 m<sup>3</sup>

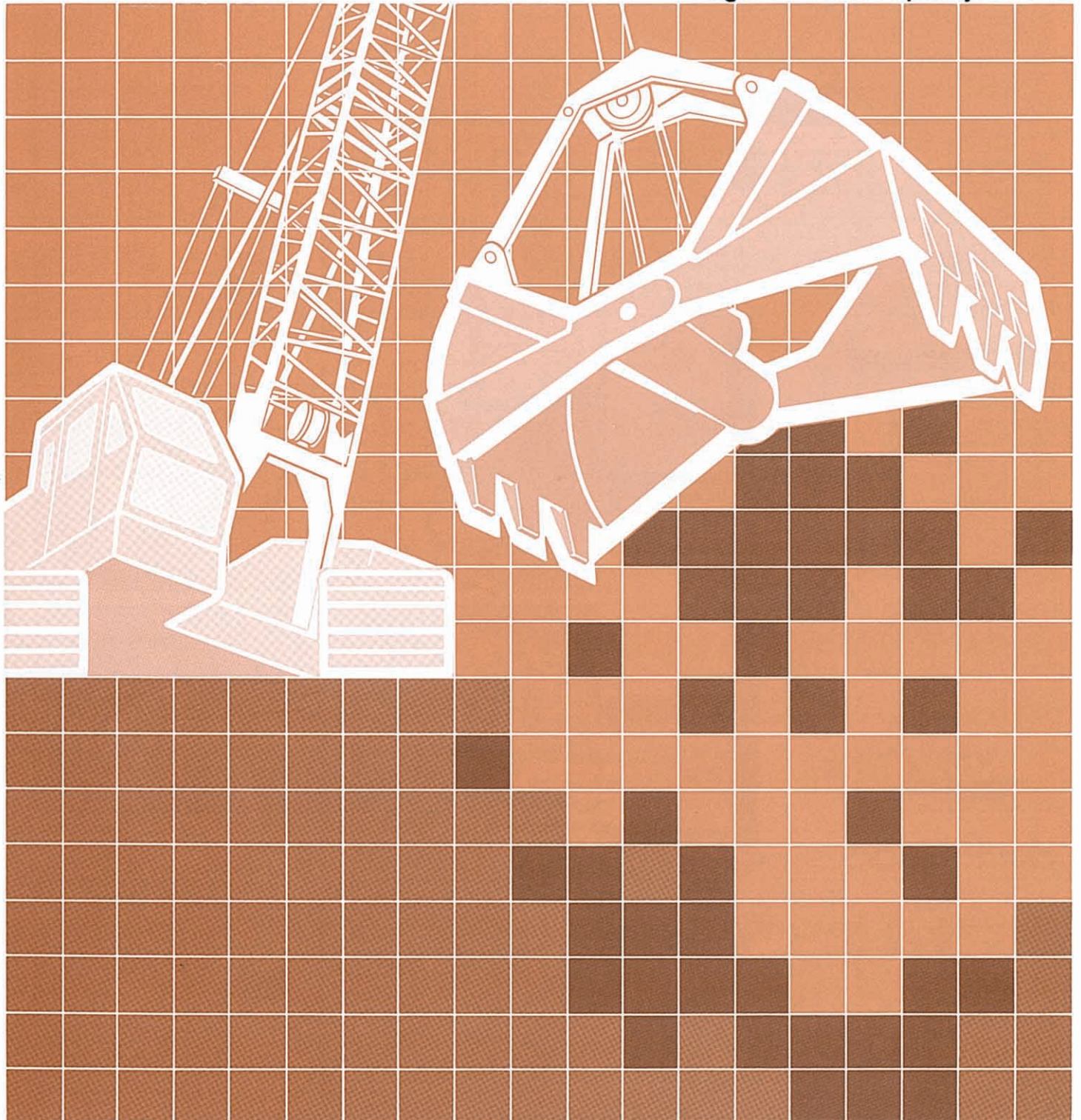



# Front Attachments

## Basic Machine

STD. Basic Machine

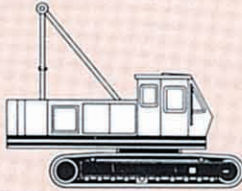

## Earth Drill

Basic Machine  
With Earth Drill attachment

Max. drilling bore:  
1700 mm (5'7")  
Max. drilling depth:  
42 m (137'9")  
52 m (170'7")  
(with stem rod)



## Boom



Lift crane .....	10 — 34 m (32'10" — 111'7")
Pile driver .....	10 — 16 m (32'10" — 52'6")
Clamshell .....	10 — 19 m (32'10" — 62'4")
Dragline .....	10 — 19 m (32'10" — 62'4")

## Attachment

Boom support type  
pile driver  
16 — 22 m  
(52'6" — 72'2")

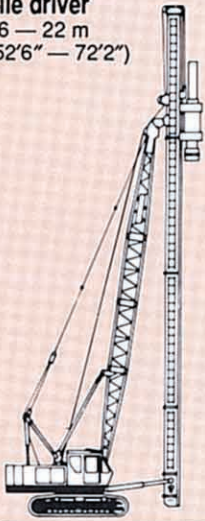

Clamshell bucket



0.8 — 1.2 m<sup>3</sup>  
(1 — 1.57 cu yd)

Tagline  
Hydraulic type

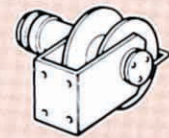

Max. digging depth  
36 m (118'1")

Dragline bucket

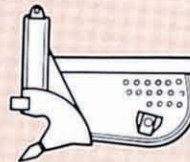

0.6 — 1.0 m<sup>3</sup>  
(0.78 — 1.31 cu yd)

Fair - lead

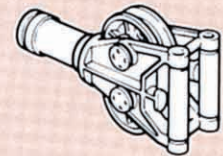

## Hook Blocks

15-metric ton



30-metric ton

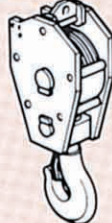

Auxiliary jib

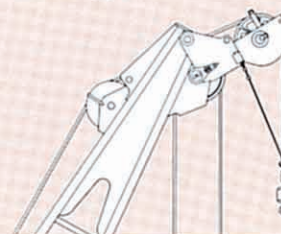

5-metric ton hook





# Power Transmission Mechanism and Hydraulic System

- 1 Variable displacement pump
- 2 Fixed displacement pump
- 3 Fixed displacement motor
- 4 Counterbalance valve
- 5 Brake valve
- 6 Control valve
- 7 Filter
- 8 Hydraulic tank
- 9 Oil cooler
- 10 Engine
- 11 Main hoist drum
- 12 Aux. hoist drum
- 13 Boom hoist drum
- 14 Center joint
- 15 Swing mechanism
- 16 Swing circle
- 17 Travel mechanism
- 18 Sprocket
- 19 Operator's cab

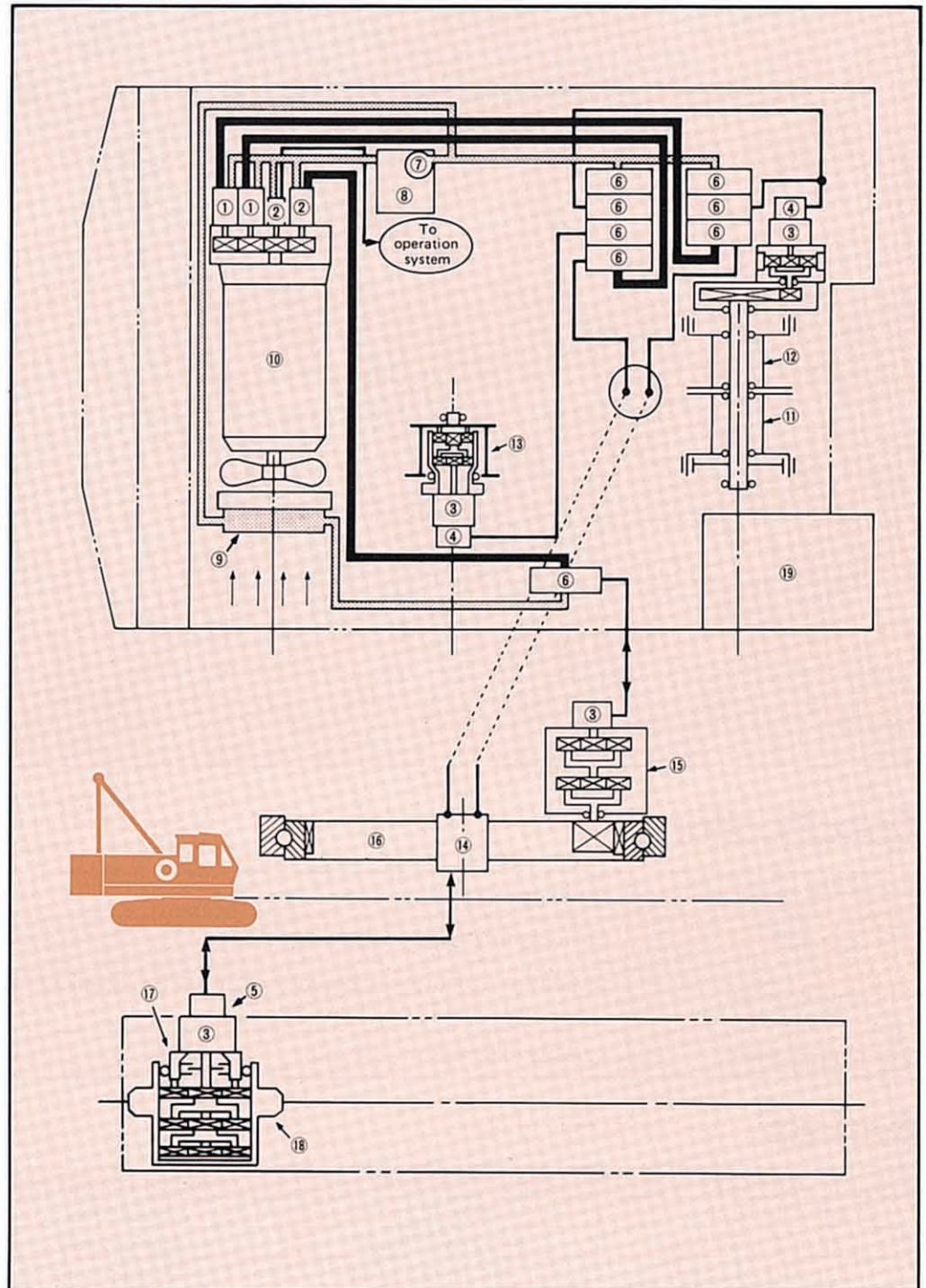



# DRAGLINE

## Dimensions

Unit: mm (ft in)

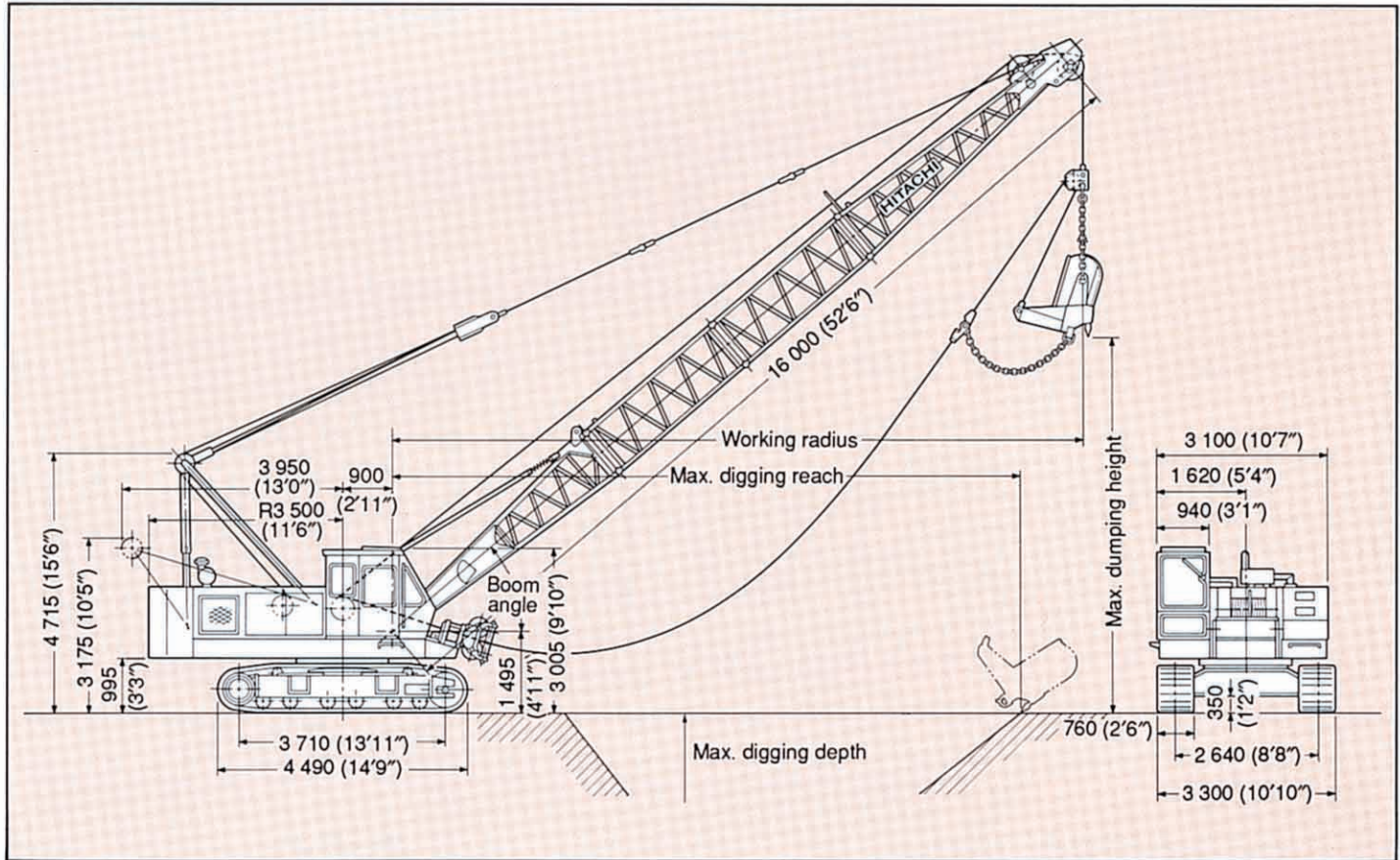

## Specifications

Max. rated load	3 300 kg (7 300 lb)
Boom length	10 m (32'10") — 19 m (62'4")
Operating weight	35 500 kg (78 000 lb) equipped with 10 m (32'10") boom with 1.0 m <sup>3</sup> (1.31 cu yd) bucket and 8 800 kg (19 400 lb) counterweight
Ground pressure	0.58 bar (0.58 kgf/cm <sup>2</sup> , 8.41 psi)

## Buckets

Capacity	Self weight	Application	Bucket clearance: H
0.6 m <sup>3</sup> (0.78 cu yd)	1 000 kg (2 200 lb)	Heavy-duty	4.0 m (13'2")
0.8 m <sup>3</sup> (1.05 cu yd)	1 200 kg (2 700 lb)	Medium-duty	4.0 m (13'2")
1.0 m <sup>3</sup> (1.31 cu yd)	1 600 kg (3 500 lb)	Medium-duty	4.2 m (13'9")



## Dragline Ratings and Working Ranges

Boom length	Working radius		Boom angle	Boom point height		Max. digging reach		Max. digging depth		Rated loads				
	m	ft in		m	ft in	m	ft in	m	ft in	JIS rating	BS rating		PCSA rating	
m (ft in)	m	ft in	degree	m	ft in	m	ft in	m	ft in	kg	kg	lb	kg	lb
10.0 (32'10")	7.7	25'3"	50	9.2	30'2"	11.8	38'9"	5.9	19'4"	3 300	3 300	7 280	3 300	7 280
	8.9	29'2"	40	7.9	25'11"	12.5	41'0"	6.4	21'0"	3 300	3 300	7 280	3 300	7 280
	9.9	32'6"	30	6.4	21'0"	12.8	42'0"	6.7	22'0"	3 300	3 300	7 280	3 300	7 280
13.0 (42'8")	9.7	31'10"	50	11.4	37'5"	14.7	48'3"	8.1	26'7"	3 300	3 300	7 280	3 300	7 280
	11.2	36'9"	40	9.8	32'2"	15.7	51'6"	8.8	28'10"	3 300	3 300	7 280	3 300	7 280
	12.5	41'0"	30	7.9	26'0"	16.1	52'10"	9.1	29'10"	3 300	3 300	7 280	3 300	7 280
16.0 (52'6")	11.6	38'1"	50	13.7	44'11"	17.8	58'5"	10.4	34'1"	3 300	3 300	7 280	3 300	7 280
	13.5	44'3"	40	11.7	38'5"	18.8	61'8"	11.2	36'9"	3 200	3 300	7 280	3 300	7 280
	15.1	49'6"	30	9.4	30'10"	19.3	63'4"	11.5	37'9"	2 500	3 000	6 610	3 000	6 610
19.0 (62'4")	13.5	44'3"	50	16.0	52'6"	20.7	67'11"	12.6	41'4"	3 000	3 300	7 280	3 300	7 280
	15.8	51'10"	40	13.7	44'11"	21.2	69'7"	13.0	42'8"	2 500	2 700	5 950	2 650	5 840
	17.7	58'1"	30	10.9	35'9"	22.6	74'2"	14.0	45'11"	2 000	2 300	5 070	2 250	4 960

### Notes:

1. The rated loads shown include the bucket weight. The load to be actually lifted is the rated load minus bucket weight.
2. Maximum digging reach/depth may vary considerable depending on digging condition and the skill of the operator.
3. Counterweight is 8 800 kg (19 400 lb).



# CLAMSHELL

## Dimensions

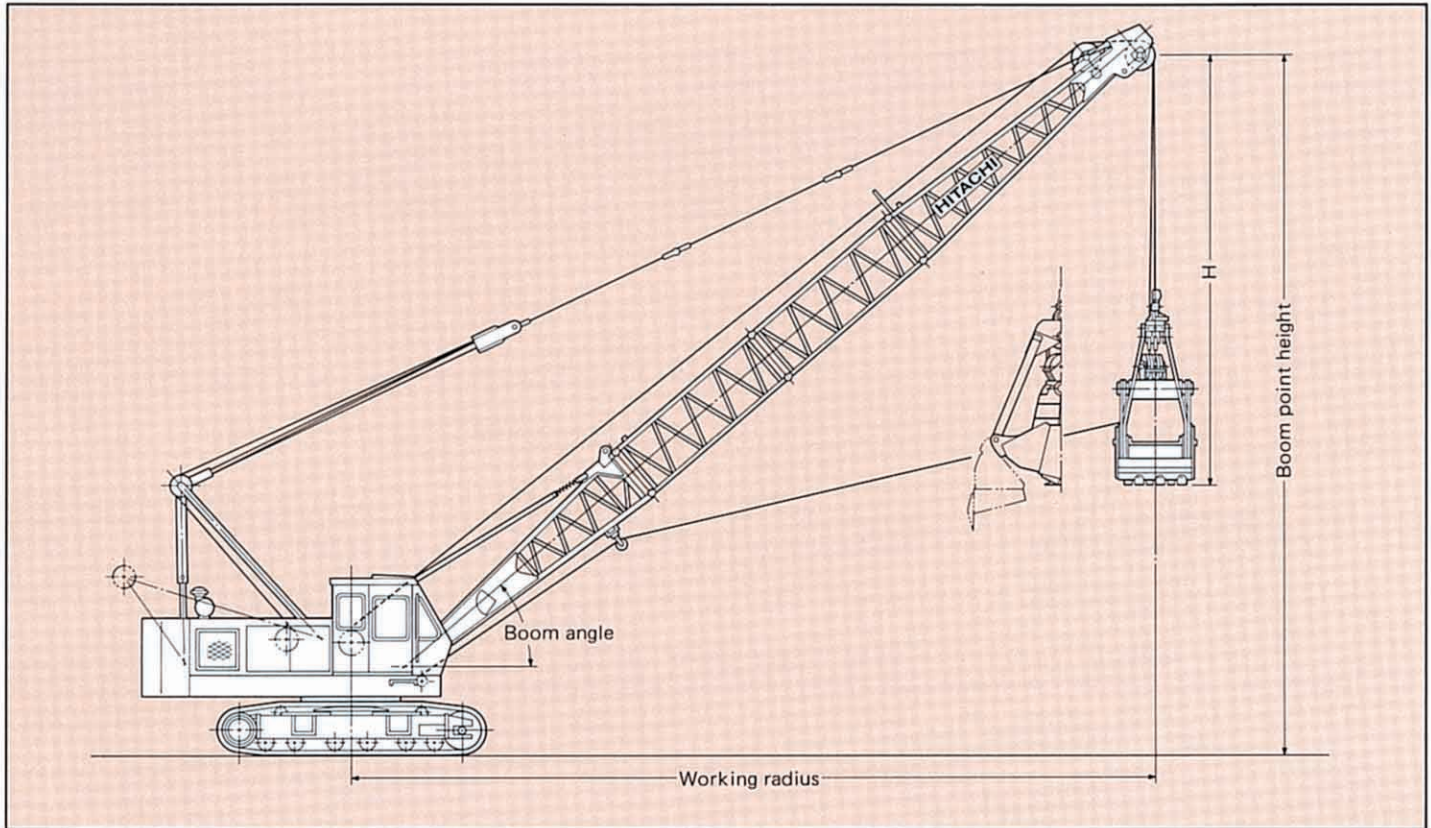

## Specifications

<b>Bucket capacity</b>	0.8 m <sup>3</sup> (1 cu yd), 1.0 m <sup>3</sup> (1.31 cu yd), 1.2 m <sup>3</sup> (1.57 cu yd)
<b>Boom length</b>	10.0 m (32'10") — 19.0 m (62'4")
<b>Ground pressure</b>	0.58 bar (0.58 kgf/cm <sup>2</sup> , 8.25 psi)
<b>Operating weight</b>	35 000 kg (77 000 lb) equipped with 10.0 m (32'10") boom, 1.0 m <sup>3</sup> (1.31 cu yd) bucket and 8 800 kg (19 400 lb) counterweight

### BUCKETS

Capacity	Self weight	Bucket clearance: H
0.8 m <sup>3</sup> (1 cu yd)	2000 kg (4400 lb)	5.3 m (17'5")
1.0 m <sup>3</sup> (1.31 cu yd)	2450 kg (5400 lb)	5.5 m (18'1")
*1.2 m <sup>3</sup> (1.57 cu yd)	2400 kg (5400 lb)	5.7 m (18'8")

\*1.2 m<sup>3</sup> (1.57 cu yd) bucket is light-duty service.

### TAGLINE

	Maximum digging depth
Hydraulic operated type	36.0 m (118'1")



## Clamshell Ratings and Working Ranges

Boom length	Working radius		Boom angle	Boom point height		Rated loads								
						JIS rating	BS rating (1)		BS rating (2)		PCSA rating (1)		PCSA rating (2)	
m (ft in)	m	ft in	degree	m	ft in	kg	kg	lb	kg	lb	kg	lb	kg	lb
10.0 (32'10")	5.5	18'1"	65	10.6	34'9"	5 500	6 500	14 330	5 500	12 130	6 500	14 330	5 500	12 130
	7.0	23'0"	55	9.7	31'10"	5 500	6 500	14 330	5 500	12 130	6 500	14 330	5 500	12 130
	8.3	27'3"	45	8.6	28'3"	5 500	5 800	12 790	5 500	12 130	6 400	14 110	5 500	12 130
	9.4	30'10"	35	7.2	23'7"	5 400	4 900	10 800	4 900	10 800	5 450	12 020	5 450	12 020
13.0 (42'8")	6.7	22'0"	65	13.3	43'8"	5 500	6 500	14 330	5 500	12 130	6 500	14 330	5 500	12 130
	8.7	28'7"	55	12.2	40'0"	5 500	5 350	11 790	5 350	11 790	5 950	13 120	5 500	12 130
	10.4	34'2"	45	10.7	35'1"	4 600	4 200	9 260	4 200	9 260	4 650	10 250	4 650	10 250
	11.8	38'9"	35	8.9	29'2"	3 900	3 550	7 830	3 550	7 830	3 950	8 710	3 950	8 710
16.0 (52'6")	8.0	26'3"	65	16.0	52'6"	5 500	5 900	13 010	5 500	12 130	6 500	14 330	5 500	12 130
	10.4	34'2"	55	14.6	47'11"	4 600	4 100	9 040	4 100	9 040	4 600	10 140	4 600	10 140
	12.6	41'5"	45	12.8	42'0"	3 600	3 100	6 830	3 100	6 830	3 500	7 720	3 500	7 720
	14.3	46'11"	35	10.6	34'9"	2 800	2 600	5 730	2 600	5 730	2 950	6 500	2 950	6 500
19.0 (62'4")	9.3	30'6"	65	18.8	61'8"	5 100	4 700	10 360	4 700	10 360	5 250	11 570	5 250	11 570
	12.2	40'1"	55	17.1	56'1"	3 600	3 200	7 050	3 200	7 050	3 600	7 940	3 600	7 940
	14.7	48'3"	45	14.9	48'11"	2 700	2 400	5 290	2 400	5 290	2 750	6 060	2 750	6 060
	16.8	55'2"	35	12.4	40'8"	2 300	1 980	4 370	1 980	4 370	2 250	4 960	2 250	4 960

### Notes:

- The rated loads shown include the bucket weight.  
The load to be actually lifted is the rated load minus bucket weight.
- The BS (1) and PCSA (1) rated loads shall apply to the power load lowering operation, or free fall operation in the case when buckets self weight are less than 2 500 kg (5 500 lb).
- The BS (2) and PCSA (2) rated loads shall apply to the free fall operation where buckets self weight are over 2 500 kg (5 500 lb).
- Counterweights is 8 800 kg (19 400 lb).
- Permissible boom length for clamshell operation is 10 m (32'10") to 19 m (62'4").
- Length of bucket opening/closing ropes will change according to boom length and excavation depth.
- For bucket power load lowering operation, use a combination of power load lowering and free fall operation with brake half-applied. (Aim for a free fall range within 10 m.)



# CRAWLER CRANE

## Dimensions

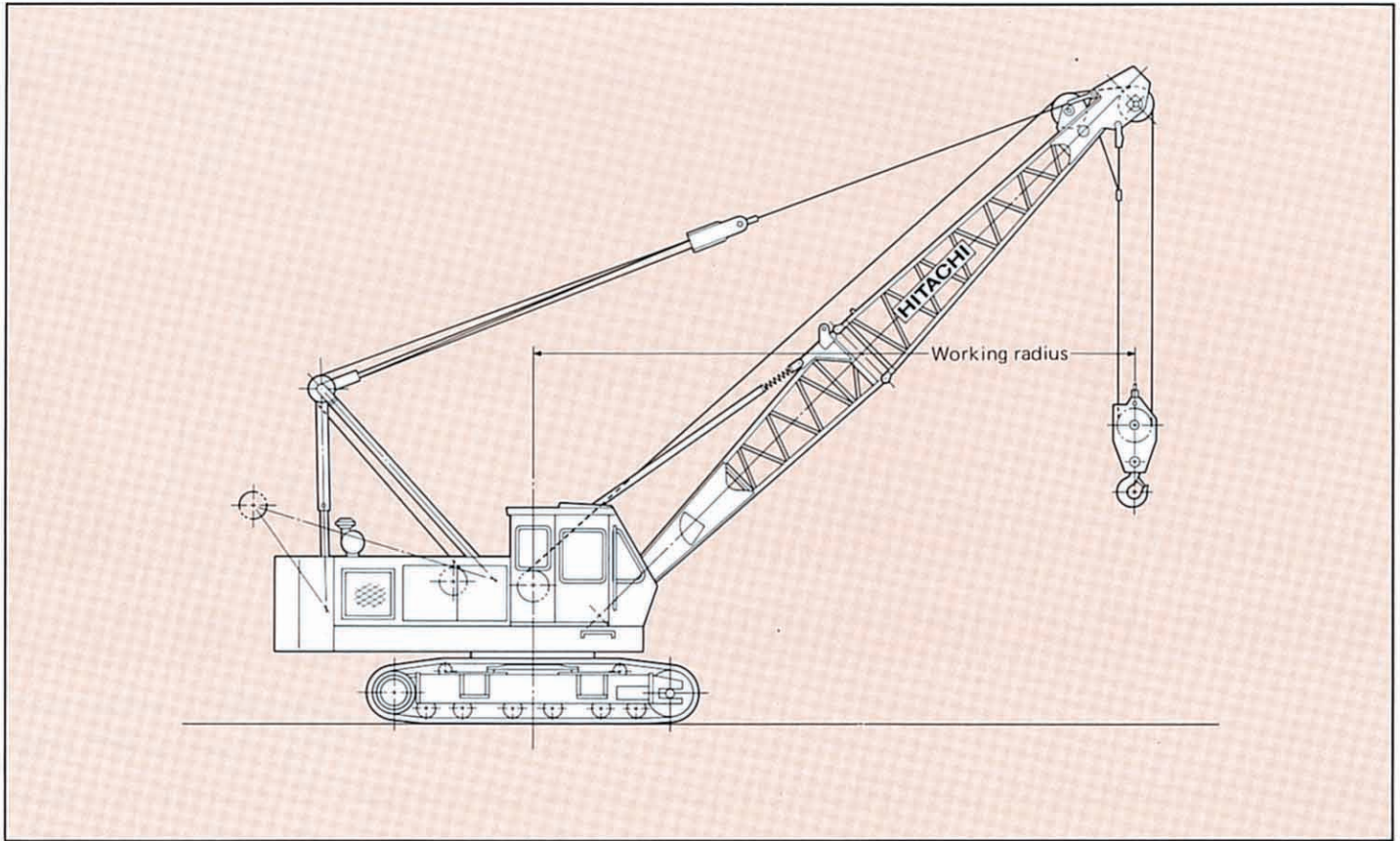

## Specifications

<b>Maximum rated load</b>		30 000 kg (66 100 lb) at 3.0 m (9'10") working radius
<b>Boom</b>	Basic boom length	10.0 m (32'10")
	Max. boom length	34.0 m (111'7")
<b>Operating weight</b>	Equipped with basic boom 30 000 kg (66 100 lb) capacity hook and 8800 kg (19 400 lb) counterweight	33 100 kg (73 000 lb)
<b>Ground pressure</b>		0.55 bar (0.55 kgf/cm <sup>2</sup> , 7.82 psi)



## HOOKS

Capacity	Self weight	Number of hoist reeving and maximum rated loads					
		5	4	3	2	1	
30 000 kg (66 100 lb)	360 kg (790 lb)	30 000 kg (66 100 lb)	26 000 kg (57 300 lb)	19 500 kg (43 000 lb)	13 000 kg (28 700 lb)		Standard for main boom
15 000 kg (33 100 lb)	320 kg (705 lb)			15 000 kg (33 100 lb)	13 000 kg (28 700 lb)		Optional for main boom
5 000 kg (11 000 lb)	130 kg (290 lb)					5 000 kg (11 000 lb)	Optional for aux. jib

## DRUMS

### Dimensions

	Rope dia.	Width	Drum p.c.d.	Max. rope capacity
Main hoist drum	22 mm (0.866")	267 mm (10.5")	462 mm (18.19")	178 mm (584')
Aux. hoist drum	22 mm (0.866")	267 mm (10.5")	462 mm (18.19")	178 mm (584')

### Line speed and line pull

	Max. line speed m/min (ft/min)				Effective line pull	@	Line speed	Max. starting line pull	Max. running line pull
	Hoisting		Lowering						
Main hoist drum	H	70 (230)	H	70 (230)	108 kN (11 000 kgf 24 300 lbf)	@	34 m/min (112 ft/min)	137 kN (14 000 kgf 30 900 lbf)	143 kN (14 600 kgf 32 000 lbf)
	L	35 (115)	L	35 (115)					
Aux. hoist drum	H	70 (230)	H	70 (230)	108 kN (11 000 kgf 24 300 lbf)	@	34 m/min (112 ft/min)	137 kN (14 000 kgf 30 900 lbf)	143 kN (14 600 kgf 32 000 lbf)
	L	35 (115)	L	35 (115)					

#### Notes:

- Line speed and line pull are based on first layer of winding at rated engine rpm.
- Hoisting line speed varies with load.
- Line pull is based on a single line pull in high speed range.
- Effective line pull is equivalent to available line pull of mechanical drive winch.
- When starting, hydraulic motor is without rotating, the line pull is "Max. starting line pull". After motor rotating, the line pull becomes "Max. running line pull" shortly.

## BOOM HOIST DRUM

Rope diameter	Hoisting line speed	Lowering line speed
14 mm (0.551")	60 m/min (197 ft/min)	60 m/min (197 ft/min)



# Working Ranges

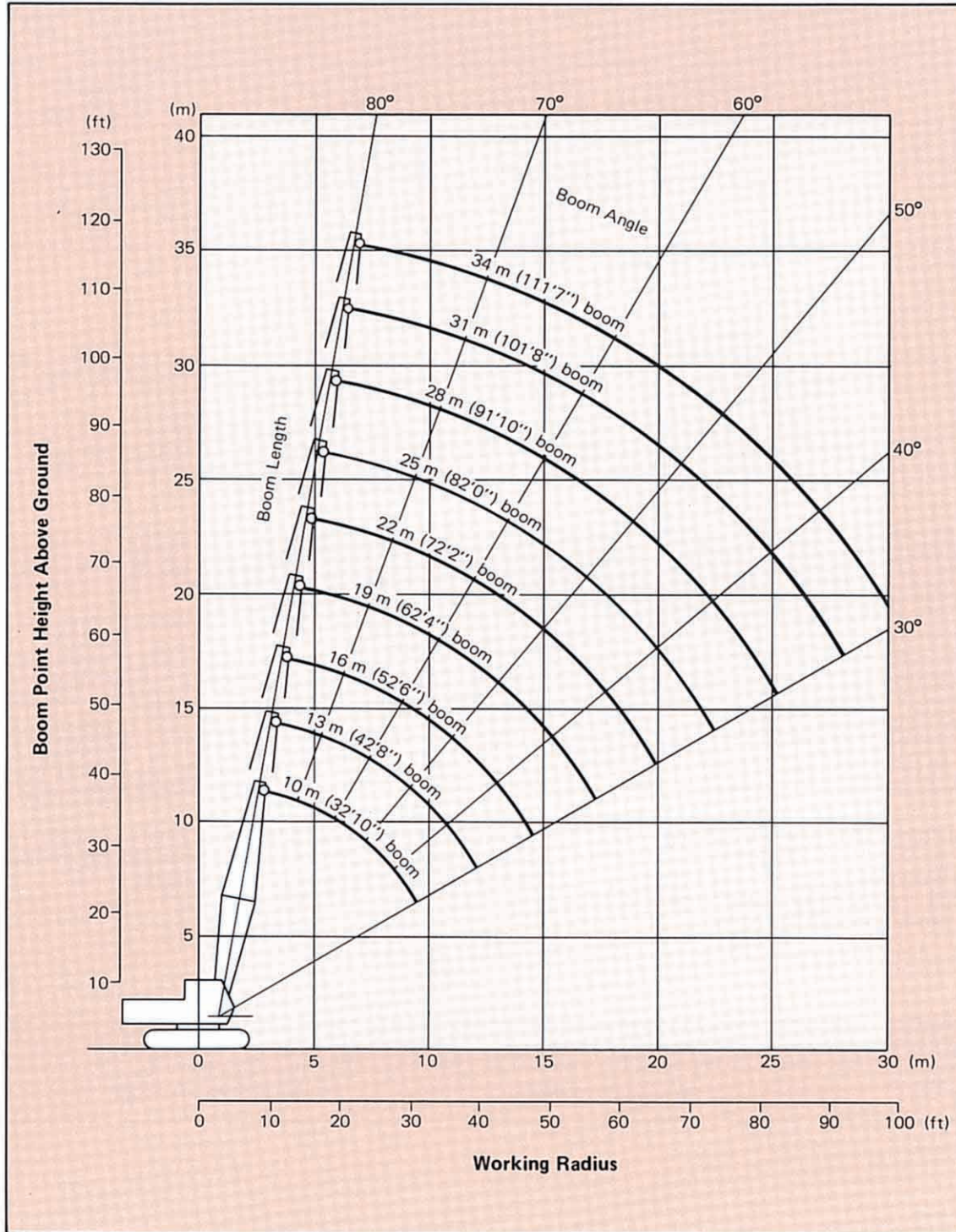

## Hook Clearance

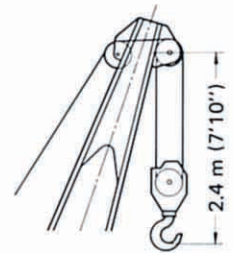



# Crane Ratings

## JIS Rating:

The rated loads shown don't exceed 78% of tipping loads with the machine on firm level ground.

## BS Rating:

The rated loads are determined according to BS (British Standard; 1981) on condition that the machine is stationed on firm, level ground.

## PCSA Rating:

The rated loads, listed are determined according to PCSA (Power Crane and Shovel Association in U.S.A.) and do not exceed 75 % of tipping load on condition that the machine is stationed on firm, level ground.

## Angle Chord Crane Boom in 360° Working Area

Boom length	Working radius		Boom angle	Boom point height		Rated load				
						JIS rating	BS rating		PCSA rating	
m (ft in)	m	ft in	degree	m	ft in	kg	kg	lb	kg	lb
10.0 (32'10")	3.0	9'10"	79.26	11.3	37'1"	30 000	30 000	66 200	30 000	66 200
	3.5	11'6"	76.31	11.2	36'9"	23 850	23 850	52 600	23 050	50 800
	4.0	13'1"	73.32	11.0	36'1"	19 400	19 400	42 800	18 750	41 300
	4.5	14'9"	70.28	10.8	35'5"	16 300	16 300	35 900	15 750	34 700
	5.0	16'5"	67.18	10.6	34'9"	14 050	14 050	31 000	13 550	29 900
	6.0	19'8"	60.72	10.1	33'2"	10 950	10 950	24 100	10 550	23 300
	7.0	23'0"	53.80	9.4	30'10"	8 900	8 900	19 600	8 600	19 000
	8.0	26'3"	46.16	8.6	28'3"	7 450	7 450	16 400	7 200	15 900
	9.0	29'6"	37.30	7.4	24'3"	6 400	6 400	14 100	6 150	13 600
9.6	31'6"	30.95	6.4	21'0"	5 900	5 800	12 800	5 600	12 300	
13.0 (42'8")	3.6	11'10"	79.07	14.2	46'7"	22 700	22 700	50 000	21 800	48 100
	4.0	13'1"	77.26	14.1	46'3"	19 350	19 350	42 700	18 700	41 200
	4.5	14'9"	74.98	14.0	45'11"	16 250	16 250	35 800	15 700	34 600
	5.0	16'5"	72.68	13.8	45'3"	13 950	13 950	30 800	13 500	29 800
	6.0	19'8"	67.96	13.5	44'4"	10 850	10 850	23 900	10 500	23 200
	7.0	23'0"	63.08	13.0	42'8"	8 800	8 800	19 400	8 500	18 700
	8.0	26'3"	57.96	12.4	40'8"	7 350	7 350	16 200	7 100	15 700
	9.0	29'6"	52.52	11.7	38'5"	6 300	6 300	13 900	6 050	13 300
	10.0	32'0"	46.64	10.8	35'5"	5 450	5 450	12 000	5 300	11 700
	12.0	39'4"	32.44	8.3	27'3"	4 300	4 300	9 480	4 150	9 150
	12.2	40'0"	30.71	7.9	25'11"	4 250	4 150	9 150	4 000	8 820

Continued on next page ➡



Boom length	Working radius		Boom angle	Boom point height		Rated load				
						JIS rating	BS rating		PCSA rating	
m (ft in)	m	ft in	degree	m	ft in	kg	kg	lb	kg	lb
16.0 (52'6")	4.1	13'5"	79.69	17.2	56'5"	18 450	18 450	40 700	17 750	39 100
	4.5	14'9"	77.86	17.1	56'1"	16 200	16 200	35 700	15 650	34 500
	5.0	16'5"	76.01	17.0	55'9"	13 900	13 900	30 700	13 400	29 500
	6.0	19'8"	72.27	16.7	54'10"	10 750	10 750	23 700	10 400	22 900
	7.0	23'0"	68.45	16.3	53'6"	8 700	8 700	19 200	8 400	18 500
	8.0	26'3"	64.52	15.9	52'2"	7 250	7 250	16 000	7 000	15 400
	9.0	29'6"	60.45	15.3	50'2"	6 200	6 200	13 700	6 000	13 200
	10.0	32'10"	56.20	14.7	48'3"	5 350	5 350	11 800	5 200	11 500
	12.0	39'4"	46.94	13.0	42'8"	4 200	4 200	9 260	4 050	8 930
	14.0	45'11"	35.91	10.7	35'1"	3 350	3 350	7 390	3 250	7 170
14.8	48'7"	30.56	9.4	30'10"	2 900	3 050	6 730	3 000	6 620	
19.0 (52'4")	4.6	15'1"	79.80	20.2	66'3"	15 450	15 450	34 100	14 850	32 700
	5.0	16'5"	78.26	20.1	65'11"	13 850	13 850	30 500	13 350	29 400
	6.0	19'8"	75.15	19.8	65'0"	10 700	10 700	23 600	10 350	22 800
	7.0	23'0"	72.00	19.5	64'0"	8 650	8 650	19 100	8 350	18 400
	8.0	26'3"	68.78	19.1	62'8"	7 200	7 200	15 900	6 950	15 300
	9.0	29'6"	65.49	18.7	61'4"	6 150	6 150	13 600	5 900	13 000
	10.0	32'10"	62.11	18.2	59'9"	5 300	5 300	11 700	5 100	11 200
	12.0	39'4"	54.98	16.9	55'5"	4 100	4 100	9 040	3 950	8 710
	14.0	45'11"	47.14	15.3	50'2"	3 300	3 250	7 170	3 150	6 950
	16.0	52'6"	38.10	13.0	42'8"	2 700	2 650	5 840	2 600	5 730
17.4	57'1"	30.46	10.9	35'9"	2 450	2 300	5 070	2 250	4 960	
22.0 (72'2")	5.1	16'9"	79.88	23.1	75'9"	13 400	13 400	29 500	12 850	28 300
	6.0	19'8"	77.22	22.9	75'2"	10 600	10 600	23 400	10 250	22 600
	7.0	23'0"	74.53	22.6	74'2"	8 550	8 550	18 900	8 250	18 200
	8.0	26'3"	71.80	22.3	73'2"	7 100	7 100	15 700	6 850	15 100
	9.0	29'6"	69.02	22.0	72'2"	6 000	6 000	13 200	5 800	12 800
	10.0	32'10"	66.19	21.5	70'6"	5 200	5 200	11 500	5 000	11 000
	12.0	39'4"	60.33	20.5	67'3"	4 000	3 950	8 710	3 850	8 490
	14.0	45'11"	54.08	19.2	63'0"	3 150	3 150	6 950	3 050	6 730
	16.0	52'6"	47.29	17.5	57'5"	2 550	2 500	5 510	2 500	5 510
	18.0	59'1"	39.62	15.4	50'6"	2 100	2 050	4 520	2 050	4 520
	20.0	65'7"	30.38	12.4	40'8"	1 800	1 700	3 750	1 700	3 750

Continued on next page ➡



Boom length	Working radius		Boom angle	Boom point height		Rated load				
						JIS rating	BS rating		PCSA rating	
m (ft in)	m	ft in	degree	m	ft in	kg	kg	lb	kg	lb
25.0 (82'0")	6.0	19'8"	78.78	26.0	85'4"	10 550	10 550	23 300	10 200	22 500
	7.0	23'0"	76.43	25.8	84'8"	8 500	8 500	18 700	8 200	18 100
	8.0	26'3"	74.05	25.5	83'8"	7 050	7 050	15 500	6 800	15 000
	9.0	29'6"	71.65	25.2	82'8"	6 000	6 000	13 200	5 750	12 700
	10.0	32'10"	69.20	24.8	81'4"	5 150	5 150	11 400	4 950	10 900
	12.0	39'4"	64.19	23.9	78'5"	3 950	3 900	8 600	3 800	8 380
	14.0	45'11"	58.95	22.8	74'10"	3 100	3 050	6 730	3 000	6 620
	16.0	52'6"	53.39	21.4	70'3"	2 500	2 450	5 400	2 400	5 290
	18.0	59'1"	47.40	19.7	64'8"	2 050	2 000	4 410	2 000	4 410
	20.0	65'7"	40.73	17.6	57'9"	1 700	1 600	3 530	1 650	3 640
	22.0	72'2"	32.99	14.9	48'11"	1 400	1 300	2 870	1 350	2 980
22.6	74'2"	30.33	13.9	45'7"	1 350	1 250	2 760	1 300	2 870	
28.0 (91'10")	6.5	21'4"	80.00	29.0	95'2"	9 450	9 450	20 800	9 150	20 200
	7.0	23'0"	77.91	28.8	94'6"	8 400	8 400	18 500	8 100	17 900
	8.0	26'3"	75.80	28.6	93'10"	6 950	6 950	15 300	6 700	14 800
	9.0	29'6"	73.68	28.3	92'10"	5 850	5 850	12 900	5 650	12 500
	10.0	32'10"	71.53	28.0	91'10"	5 000	5 000	11 000	4 850	10 700
	12.0	39'4"	67.14	27.2	89'3"	3 800	3 800	8 380	3 700	8 160
	14.0	45'11"	62.60	26.3	86'3"	3 000	2 950	6 510	2 900	6 400
	16.0	52'6"	57.86	25.1	82'4"	2 400	2 300	5 070	2 300	5 070
	18.0	59'1"	52.85	23.7	77'9"	1 950	1 850	4 080	1 850	4 080
	20.0	65'7"	47.48	22.0	72'2"	1 600	1 500	3 310	1 500	3 310
	22.0	72'2"	41.59	19.9	65'4"	1 300	1 200	2 650	1 250	2 760
	24.0	78'9"	34.91	17.3	56'9"	1 050	950	2 100	1 000	2 210
25.2	82'8"	30.28	15.4	50'6"	900	800	1 760	900	1 990	
31.0 (101'9")	7.0	23'0"	79.10	31.9	104'8"	8 300	8 300	18 300	8 000	17 600
	8.0	26'3"	77.20	31.7	104'0"	6 850	6 850	15 100	6 600	14 600
	9.0	29'6"	75.30	31.4	103'0"	5 750	5 750	12 700	5 550	12 200
	10.0	32'10"	73.37	31.1	102'0"	4 950	4 900	10 800	4 750	10 500
	12.0	39'4"	69.46	30.5	100'1"	3 750	3 700	8 160	3 600	7 940
	14.0	45'11"	65.45	29.6	97'1"	2 900	2 850	6 280	2 800	6 170
	16.0	52'6"	61.29	28.6	93'10"	2 300	2 200	4 850	2 200	4 850
	18.0	59'1"	56.97	27.4	89'11"	1 800	1 750	3 860	1 800	3 970
	20.0	65'7"	52.41	25.9	85'0"	1 500	1 350	2 980	1 450	3 200
	22.0	72'2"	47.55	24.2	79'5"	1 200	1 050	2 320	1 150	2 540
	24.0	78'9"	42.27	22.2	72'10"	960	850	1 870	950	2 100
	26.0	85'4"	36.38	19.7	64'8"	800	650	1 430	750	1 650

Continued on next page ➡



Boom length	Working radius		Boom angle	Boom point height		Rated load				
						JIS rating	BS rating		PCSA rating	
m (ft in)	m	ft in	degree	m	ft in	kg	kg	lb	kg	lb
34.0 (111'7")	8.0	26'3"	78.35	34.8	114'2"	6 750	6 750	14 900	6 500	14 300
	9.0	29'6"	76.62	34.5	113'2"	5 650	5 650	12 500	5 450	12 000
	10.0	32'10"	74.88	34.3	112'6"	4 800	4 800	10 600	4 650	10 300
	12.0	39'4"	71.35	33.6	110'3"	3 600	3 550	7 830	3 500	7 720
	14.0	45'11"	67.74	32.9	107'11"	2 800	2 700	5 950	2 700	5 950
	16.0	52'6"	64.04	32.0	105'0"	2 200	2 100	4 630	2 100	4 630
	18.0	59'1"	60.21	30.9	101'5"	1 750	1 600	3 530	1 650	3 640
	20.0	65'7"	56.23	29.6	97'1"	1 350	1 250	2 760	1 300	2 870
	22.0	72'2"	52.05	28.2	92'6"	1 100	950	2 100	1 050	2 320
	24.0	78'9"	47.61	26.5	86'11"	850	700	1 540	800	1 760
	26.0	85'4"	42.82	24.4	80'1"	650	500	1 100	600	1 320

## Rated Load for Main Boom

### Notes:

1. The rated loads shown are based on the machine on firm level ground without traveling.
2. The rated loads shown include the weights of all lifting attachments, such as hook and bucket. The load to be actually lifted is the rated load minus the weight of all lifting attachments.
3. When the auxiliary jib is attached, the load to be actually lifted is the rated load minus 200 kg (440 lb).
4. The auxiliary jib can be attached to boom of 10.0 m (32'10") to 31.0 m (101'9") long.
5. The rated load for auxiliary jib is equal to that of main boom at the same working radius, but do not exceed maximum rated load 5 000 kg (11 000 lb).
6. Counterweight is 8 800 kg (19 400 lb).



## Main Boom Construction

Boom length	10.0 m (32'10")	13.0 m (42'8")	16.0 m (52'6")	19.0 m (62'4")	22.0 m (72'2")	25.0 m (82'0")	28.0 m (91'10")	31.0 m (101'8")	34.0 m (111'7")	
Element										
Upper boom	5.0 m (16'5")	1	1	1	1	1	1	1	1	
Lower boom	5.0 m (16'5")	1	1	1	1	1	1	1	1	
Boom insert	3.0 m (9'10")	—	1	2	1	2	1	2	1	2
Boom insert	6.0 m (19'8")	—	—	—	1	1	2	2	3	3
Available hook	30 000 kg (66 100 lb) hook					15 000 kg (33 100 lb) hook				
Number of rope reeving	5	4	4	4	3	2	2	2	2	
Boom available with auxiliary jib	←—————→									✕

### Auxiliary jib (Optional)

Attachable to main boom top for hoisting lightweight load quickly with a single rope used. (Never use the main and auxiliary hooks at the same time.)

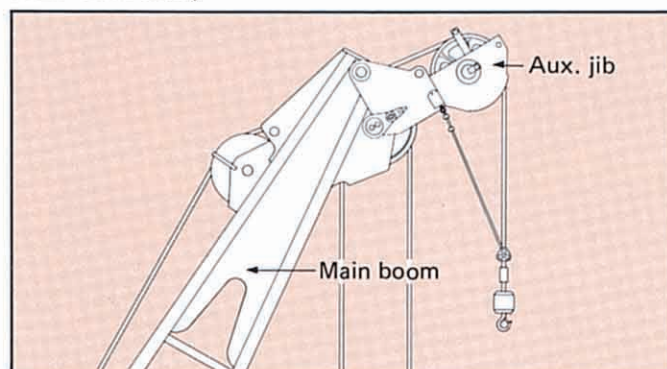



# EARTH DRILL

## Dimensions

Unit: mm (ft in)

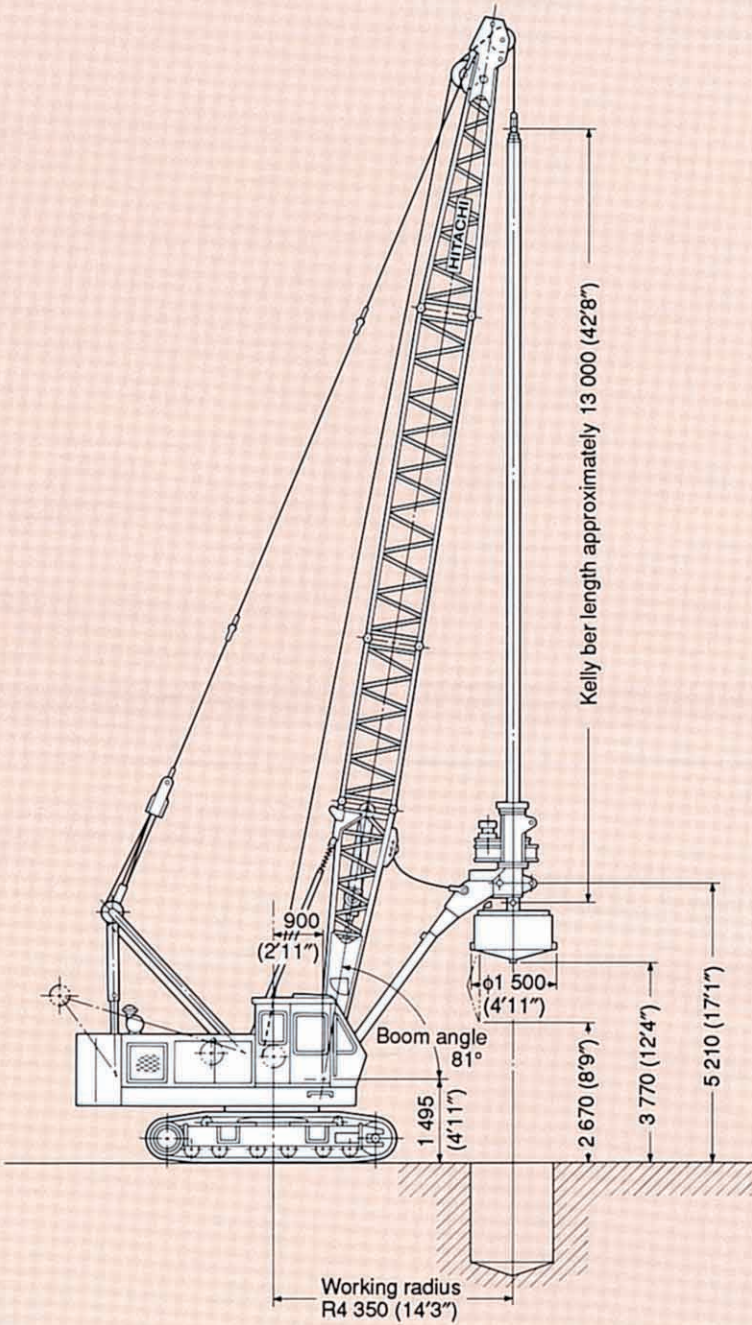



## Specifications

<b>Boom length</b>		19.0 m (62'4")
<b>Drilling bore</b>	Common earth	1 500 mm (4'11")
	Loam or soft silt	1 700 mm (5'7") 2 000 mm (6'7") (with reamer knife) *1
<b>Drilling depth</b>	Without stem rod	42 m (137'10")
	With stem rod	52 m (170'7")
<b>Bucket rotation torque</b>		40.2 kN·m (4 100 kgf·m, 29 700 ft·lbf) 49.1 kN·m (5 000 kgf·m, 36 200 ft·lbf), reverse
<b>Bucket hoist line pull</b>		124 kN (12 600 kgf, 27 800 lbf)
<b>Auxiliary hoisting load</b> *2		Max. 4 900 kg (10 800 lb)
<b>Speeds</b>	Bucket rotation *3	High: 30 min <sup>-1</sup> (30 rpm) Low: 15 min <sup>-1</sup> (15 rpm)
	Bucket hoist (line speed) *3	High: 70 m/min (230 ft/min) Low: 35 m/min (115 ft/min)
	Auxiliary drum hoist (line speed) *3	High: 70 m/min (230 ft/min) Low: 35 m/min (115 ft/min)
	Boom hoist (line speed) *3	60 m/min (197 ft/min)
	Swing	0 — 4.0 min <sup>-1</sup> (0 — 4.0 rpm)
	Travel *3	0 — 1.8 km/h (0 — 1.12 mph)
<b>Counterweight</b>		8 800 kg (19 400 lb)
<b>Ground pressure</b>		0.70 bar (0.70 kfg/cm <sup>2</sup> , 9.9 psi)
<b>Operating weight</b>		42 400 kg (93 500 lb)
		equipped with 760 mm (30") shoes

### Notes:

\*1. The reamer knife should be used for drilling an enlarged hole to insert a stand pipe.

\*2. Auxiliary hoisting load varies according to boom angle.

\*3. Bucket rotation, line speeds and travel speed may vary with load.

## Drilling Bucket

Bucket D1 mm (ft in)	Side cutter D2 mm (ft in)	Reamer knife D3 mm (ft in)	Height H mm (ft in)	Capacity m <sup>3</sup> (cu yd)	Self weight kg (lb)	Remarks
1 580 (5'2")	1 700 (5'7")	2 000 (6'7")	450 (1'6")	0.86 (1.12 cu yd)	1 100 (2 420)	Light duty service
1 480 (4'10")	1 600 (5'3")	1 900 (6'3")	500 (1'8")	0.83 (1.09 cu yd)	930 (2 050)	Light duty service
1 380 (4'6")	1 500 (4'11")	1 800 (5'11")	650 (2'2")	0.94 (1.23 cu yd)	900 (1 980)	
1 280 (4'2")	1 400 (4'7")	1 700 (5'7")	700 (2'4")	0.87 (1.14 cu yd)	830 (1 830)	
1 180 (3'11")	1 300 (4'3")	1 600 (5'3")	750 (2'6")	0.8 (1 cu yd)	770 (1 690)	
1 080 (3'7")	1 200 (3'11")	1 500 (4'11")	900 (2'11")	0.8 (1 cu yd)	730 (1 610)	
980 (3'3")	1 100 (3'7")	1 400 (4'7")	900 (2'11")	0.57 (0.75 cu yd)	655 (1 440)	
880 (2'11")	1 000 (3'3")	1 300 (4'3")	900 (2'11")	0.54 (0.71 cu yd)	490 (1 080)	

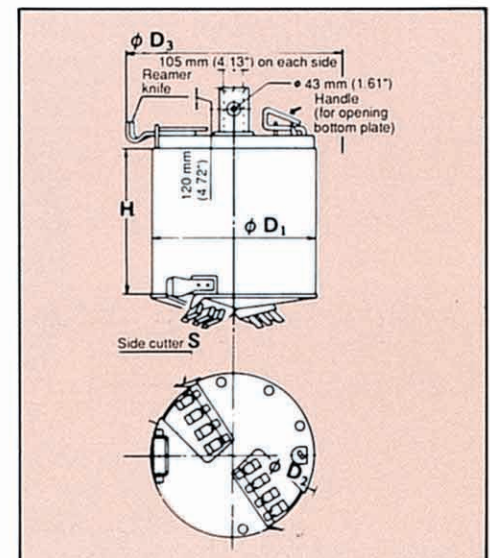



# BOOM-SUPPORT TYPE With Angle Chord Boom

## Dimensions

Unit: mm (ft in)

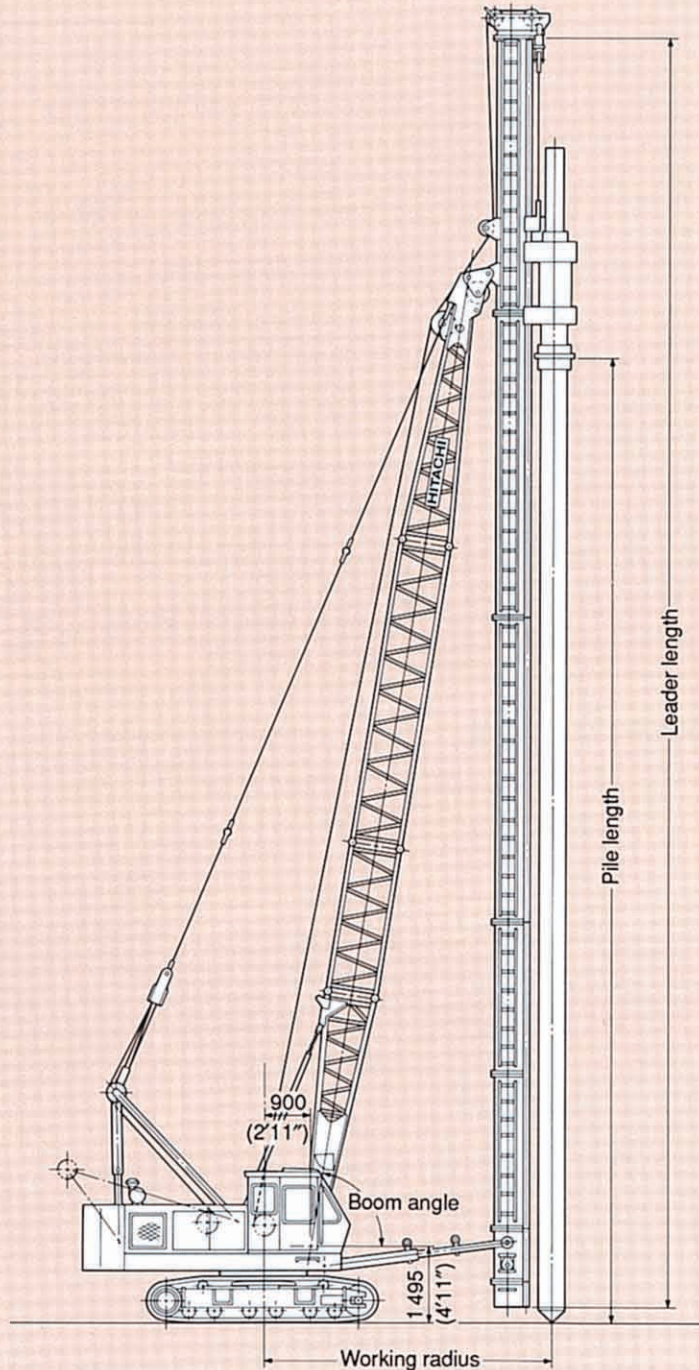



# PILE DRIVER

## Specifications

Leader		35S									
Counterweight	kg (lb)	10 800 kg (23 800 lb)									
Hammer		25					35				
Hammer weight	kg (lb)	5 500 (12 100)					8 500 (18 700)				
Cap weight	kg (lb)	500 (1 100)					1 000 (2 200)				
Boom length	m (ft in)	10 (32'10")	13 (42'8")	16 (52'6")	10 (32'10")	13 (42'8")	16 (52'6")	10 (32'10")	13 (42'8")	16 (52'6")	19 (62'4")
Leader length	m (ft in)	16 (52'6")	19 (62'4")	22 (72'2")	16 (52'6")	19 (62'4")	22 (72'2")	16 (52'6")	19 (62'4")	22 (72'2")	25 (82'0")
Allowable pile length	m (ft in)	9 (29'6")	12 (39'4")	15 (49'3")	9 (29'6")	12 (39'4")	15 (49'3")	9 (29'6")	12 (39'4")	15 (49'3")	18 (59'0")
		R	W	R	W	R	W	R	W	R	W
Boom angle (degree)	82	3.9 (12'10")	5.0 (11.0)	4.3 (14'1")	5.0 (11.0)	4.7 (15'5")	5.0 (11.0)	3.9 (12'10")	7.0 (15.4)	4.4 (14'5")	5.4 (11.9)
	81	4.1 (13'5")	5.0 (11.0)	4.6 (15'1")	5.0 (11.0)	5.0 (16'5")	4.8 (10.6)	4.1 (13'5")	7.0 (15.4)	4.6 (15'1")	4.2 (9.2)
	80	4.3 (14'1")	5.0 (11.0)	4.8 (15'9")	5.0 (11.0)	5.3 (17'5")	3.8 (8.4)	4.3 (14'1")	7.0 (15.4)	4.8 (15'9")	3.1 (6.8)
	79	4.4 (14'5")	5.0 (11.0)	5.0 (16'5")	5.0 (11.0)			4.5 (14'9")	6.6 (14.6)	5.0 (16'5")	2.2 (4.9)
	78	4.6 (15'1")	5.0 (11.0)	5.2 (17'1")	5.0 (11.0)			4.6 (15'1")	5.6 (12.3)	5.3 (17'5")	1.3 (2.9)
	77	4.8 (15'9")	5.0 (11.0)	5.5 (18'1")	4.5 (9.9)			4.8 (15'9")	4.8 (10.6)		
Operating weight (Excluding pile weight)	kg (lb)	45 100 — 46 600 (99 400 — 102 700)					48 600 — 49 500 (107 100 — 109 100)				
Ground pressure (equipped with 760 mm (30") shoe)	bar (kgf/cm <sup>2</sup> , psi)	0.86 — 0.89 (0.86 — 0.89, 12.23 — 12.66)					0.92 — 0.94 (0.92 — 0.94, 13.08 — 13.37)				

Note: R . . . . Working radius: m (ft in)  
W . . . . Pile weight: 1 000 x kg (1 000 x lb)



# Specifications



## SUPERSTRUCTURE



### Engine

Model	HINO H06C-T
Type	Water-cooled, 4-cycle, 6-cylinder, direct fuel injection type diesel engine
Rated horsepower (DIN 6 270, Net)	110 kW (150 PS) 2 000 min <sup>-1</sup> (2 000 rpm)
Maximum torque	530 N·m (54 kgf·m, 391 lbf·ft) at 1 800 min <sup>-1</sup> (1 800 rpm)
Piston displacement	6.845 l (418 cu in)
Fuel tank capacity	250 l (55 Imp gal, 66 U S gal)
Electric system	24 V DC



### Main and Auxiliary Hoist Mechanism

Hoist mechanism consists of main and auxiliary drums installed on an axis. Load hoisting/lowering are done by normal/reverse rotation of axial piston motor. Smooth, precise power lowering is made possible by the hydraulic brake. A single lever gives a choice of two speeds, high or low, for hoisting/lowering. Hoist/lower speeds are proportioned to the lever stroke, allowing easy matching to job conditions.

**Clutches** Main hoist and auxiliary hoist clutches are of internal expanding friction band type. The durable, high-quality lining are used. This advanced hydraulic system gives light, positive control.

**Brakes** External contracting friction band-type mechanical brakes integrated with link lever.

**Drums** Main and auxiliary hoist drums are of special alloy cast iron. Both hoist drums are mounted on the longtime-lubricated antifriction ball bearings.



### Boom Hoist Mechanism

Completely independent operation. Boom hoisting/lowering is done by normal/reverse driving of the high-torque piston motor. Boom lowering is made by power lowering through the hydraulic system. Instant hoisting/lowering of boom is possible. Both hydraulic brake and springset hydraulic-released band-type brake offer positive and safe stopping of boom. When boom is hoisted or lowered, brakes are automatically released.

**Boom Brakes** Spring-set, hydraulic-released multiplate disc type. Brake is automatically actuated when control lever is at neutral position.

**Drum Locks** Drum pawl lock is manually controlled from operator's seat.



### Swing Mechanism

Completely independent operation. Driven by axial piston motor through reduction gear, swing speeds are freely controllable within the 0 to maximum speed with single lever stroke.  
Swing speed . . . . . 0 — 4.0 min<sup>-1</sup> (0 — 4.0 rpm)

**Swing Brake** A spring-set/hydraulic-released singleplate disc type swing brake can be hydraulically actuated by brake switch on the swing lever.

**Swing Parking Brake** A disc type swing brake is mechanically actuated by lifting up the swing parking brake lever located at the right side of operator's seat.

**Swing Lock** Manually operated mechanical lock with a rod tip which is engaged in a holder of track frame during transportation.

**Swing Circle** Single-row shear-type ball bearing with heat-treated internal gear.



## Revolving Frame

All steel welded construction, stress-relieved, precision-machined unit, especially designed for rigidity and strength.

**Gantry** Lowerable for transportation.

**Counterweight** Welded structure. Total weight 8 800 kg (19 400 lb)

## Boom

**Angle Chord Crane Boom** 935 mm (36.8") wide by, 935 mm (36.8") deep at connection, lattice construction, high tensile strength steel angle chord.

Basic boom	2-piece, total length 10.0 m (32'10"); upper section 5.0 m (16'5") and lower section 5.0 m (16'5")
Boom point	Offset boom point, 3 sheaves [462 mm (18.2") p.c.d.] mounted on antifriction bearings on boom peak.
Boom insert	3.0 m (9'10") and 6.0 m (19'8") long available with appurtenant pendants.
Connection type	Pin-connected
Boom backstop	Dual-rail, telescopic tubular construction with spring bumper.
Boom hoist bridle	Serves as connection between pendants and boom hoist wire rope reeving, equipped with 6 sheaves [300 mm (12") p.c.d.] for 12-part boom hoist wire rope reeving.

## Operator's Cab

All-weather, well-ventilated, all-round visibility, roomy operator's cab. The completely independent cab is insulated against noise and vibration. Sliding, fold-in front window swings up and stores in roof. Fully adjustable reclining seat.

## UNDERCARRIAGE

**Travel mechanism** Each track is driven by a axial piston motor through reduction gear. This mechanism allows counterrotation of tracks for maximum maneuverability in close quarters. When lever is at neutral position, both hydraulic brake and spring-set/hydraulic-released multiplate disc brake are automatically actuated to effect reliable stopping. Upper and lower rollers, sprockets and idlers are lifetime-lubricated. A hydraulic track adjuster is provided for easy tension adjustment of each track.

Gradeability . . . . . 22° (40%)  
Travel speed . . . . . 0 — 1.8 km/h (0 — 1.12 mph)

**Track Frame** All-welded, stress relieved, box section construction.

**Side Frame** Side frames of all-welded robust rolled steel, stress-relieved, box section construction.

**Track Shoes** Heat treated alloy steel castings with induction hardened roller path and driving lugs. Shoes are connected by induction-hardened steel pins.

No. of upper rollers (on each side)	2
No. of lower rollers (on each side)	6
No. of track shoes (on each side)	53
Shoe width	760 mm (30")
Optional shoe width	660 mm (26")



# HYDRAULIC SYSTEM

2 variable displacement piston pumps + 1 gear pump hydraulic system allows both independent and combined operations of all functions. Variable-displacement piston pumps not only adequately control operating speeds, but also utilize engine horsepower to maximum.

	Pump-1	Pump-2
Type of pump	Variable displacement pump	
Pressure setting	280 bar (280 kgf/cm <sup>2</sup> , 3 980 psi)	280 bar (280 kgf/cm <sup>2</sup> , 3 980 psi)
Oil flow	200 l/min (44.0 Imp gpm, 52.8 U S gpm)	200 l/min (44.0 Imp gpm, 52.8 U S gpm)
	Pump-3	Pump-4
Type of pump	Gear pump	Vane pump
Pressure setting	210 bar (210 kgf/cm <sup>2</sup> , 2 990 psi)	45 bar (45 kgf/cm <sup>2</sup> , 640 psi)
Oil flow	134 l/min (29.5 Imp gpm, 35.4 U S gpm)	32 l/min (7.0 Imp gpm, 8.5 U S gpm)

**Main and Auxiliary Hoist Motor** (Common Motor) Radial piston motor with counterbalance valve.

**Boom Hoist Motor** Axial piston motor with counterbalance valve.

**Swing Motor** Axial piston motor with spring-set/hydraulic-released singleplate disc brake.

**Travel Motor** Axial piston motor with brake valve and spring-set/hydraulic-released multiplate disc brake.

**Relief and Brake Valves** Each hydraulic circuit incorporates large-capacity relief valves to protect circuit from overload or shock load. Counterbalance valves (compensates safe, positive load lowering and prevents accidental load drop when hydraulic power is suddenly reduced) are provided for hoist motor. Brake valves (consisting of relief valve and counterbalance valve) are provided for travel circuit.

## Pressure Setting

### MAIN CIRCUIT

- Main relief valves
  - Hoist (main and aux.) travel and boom . . . . . 280 bar  
(280 kgf/cm<sup>2</sup>, 3 980 psi)
  - Swing . . . . . 210 bar  
(210 kgf/cm<sup>2</sup>, 2 990 psi)

- Overload relief valves
  - Hoist (main and aux.) circuit . . . . . 287 bar  
(287 kgf/cm<sup>2</sup>, 4 080 psi)
  - Boom hoist circuit . . . . . 265 bar (265 kgf/cm<sup>2</sup>, 3 770 psi)
  - Travel circuit . . . . . 325 bar (325 kgf/cm<sup>2</sup>, 4 620 psi)

### PILOT CIRCUIT

- Main relief valve . . . . . 45 bar (45 kgf/cm<sup>2</sup>, 640 psi)

**Line Filters** High filtration 10μ full-flow filter element is provided to keep hydraulic oil clean and ensure long-term, trouble-free operation. Pilot filter and suction filter are provided for each circuit.



# CONTROLS

**Boom, Main and Auxiliary Hoist and Travel** Remote controlled hydraulic servo. Working speed can be precisely controlled by changing lever stroke.

**Swing** Mechanical linkage type.

**Fuel Control** Two foot throttle pedals and hand throttle controls equipped as standard.

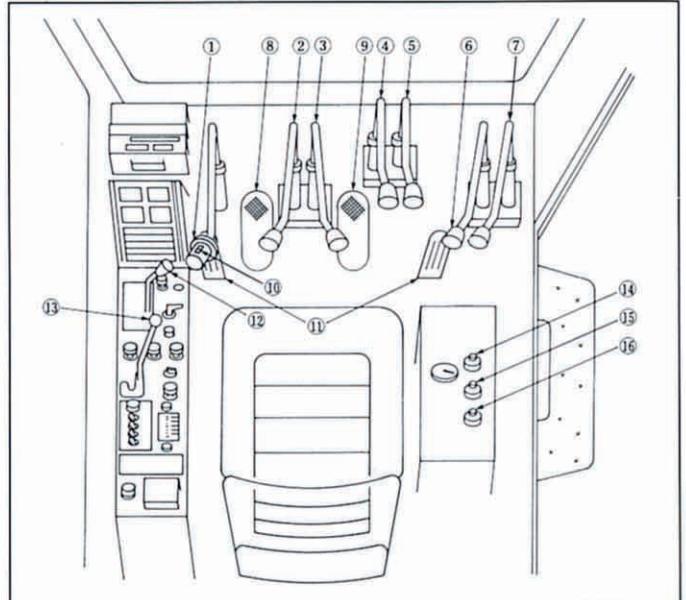

- |                                       |                       |
|---------------------------------------|-----------------------|
| 1. Swing lever                        | 11. Accelerator pedal |
| 2. Aux. clutch lever                  | 12. Accelerator lever |
| 3. Main clutch lever                  | 13. Swing lock lever  |
| 4. Travel (left) lever                | 14. Main drum lock    |
| 5. Travel (right) lever               | 15. Aux. drum lock    |
| 6. Hoist lever                        | 16. Boom drum lock    |
| 7. Boom hoist lever                   |                       |
| 8. Aux. drum brake pedal (Pedal lock) |                       |
| 9. Main drum brake pedal (Pedal lock) |                       |
| 10. Swing brake switch (Hydraulic)    |                       |



This monitor has the following functions:

- **Instruments:** Machine conditions are shown on meters.
- **Start up inspection monitor:** To check the machine condition and safety device before starting operation.
- **Safety monitor:** To warn the abnormality of the machine during operation and carelessness.

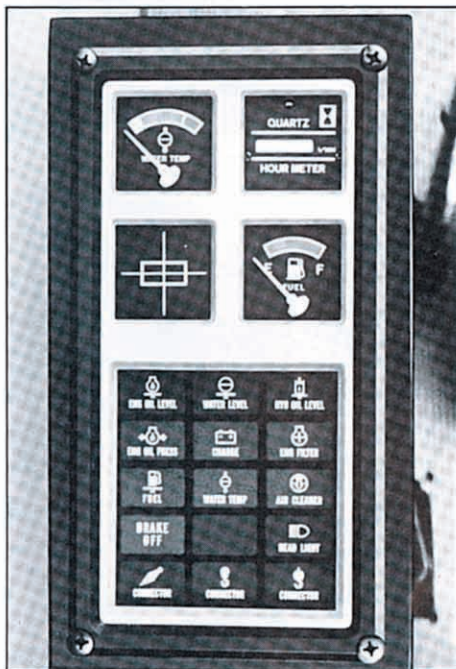

## SAFETY DEVICES

**Boom Angle Indicator** Mechanical type boom angle indicator is provided at boom foot.

**Counterbalance Valve (Brake Valve)** A Counterbalance valve is incorporated in travel motors, boom hoist motor, main and auxiliary hoist motor respectively. In case the hydraulic line is broken, this valve is automatically actuated to prevent accidents.

**Spring-set/Hydraulic-released Multiplate Disc Type Travel Brakes**

**Swing Lock and Swing Brake**

**Drum Lock** A pawl type drum lock is adopted for main drum, auxiliary drum and boom drum.

**Boom Overhoist Prevention Device** When the boom reaches its safety angle limit, a buzzer alarm sounds and boom hoisting automatically stops at the same time. A telescope type boom backstop is also installed.

For lift crane

- **Moment Limiter "Hi-Limiter"** The "Hi-Limiter" electrically detects the lifting load, and working radius from the boom angle. The detected data is calculated by a built-in microcomputer. When the lifting load reaches its alarm limit the "Hi-Limiter" buzzes, and when reaching the load limit, the control becomes inoperative.
- **Hook Overhoist Prevention Device** When the hook reaches its safety hoist limit, an alarm bell rings and an auto-stop device automatically stops at the same time.

## SERVICE REFILL CAPACITIES

	Liters	Imp gal	US gal
Fuel tank . . . . .	250.0	55.0	66.0
Engine coolant . . . . .	26.0	5.7	6.9
Engine oil . . . . .	20.0	4.4	5.3
Pump transmission . . . . .	2.7	0.59	0.71
Boom and winch hoist motor reduction device . . . . .	5.6	1.23	1.48
Winch hoist motor reduction device . . . . .	13.0	2.86	3.43
Swing reduction device . . . . .	8.7	1.9	2.3
Travel final device (On each) . . . . .	9.0	2.0	2.4
Hydraulic system (Including tank capacity) . . . . .	285.0	62.7	75.2
Hydraulic tank . . . . .	205.0	45.1	54.1

## OPTIONAL EQUIPMENT

**Operator's Cab** Electric fan, cab cooler.

**P.T.O.** Driving a generator.

A built-in type lifting magnet or a welder can be installed.

**Auxiliary Jib** Can be attached to the top of main boom for auxiliary hook-hoisting operation.



# KH AND PD SERIES

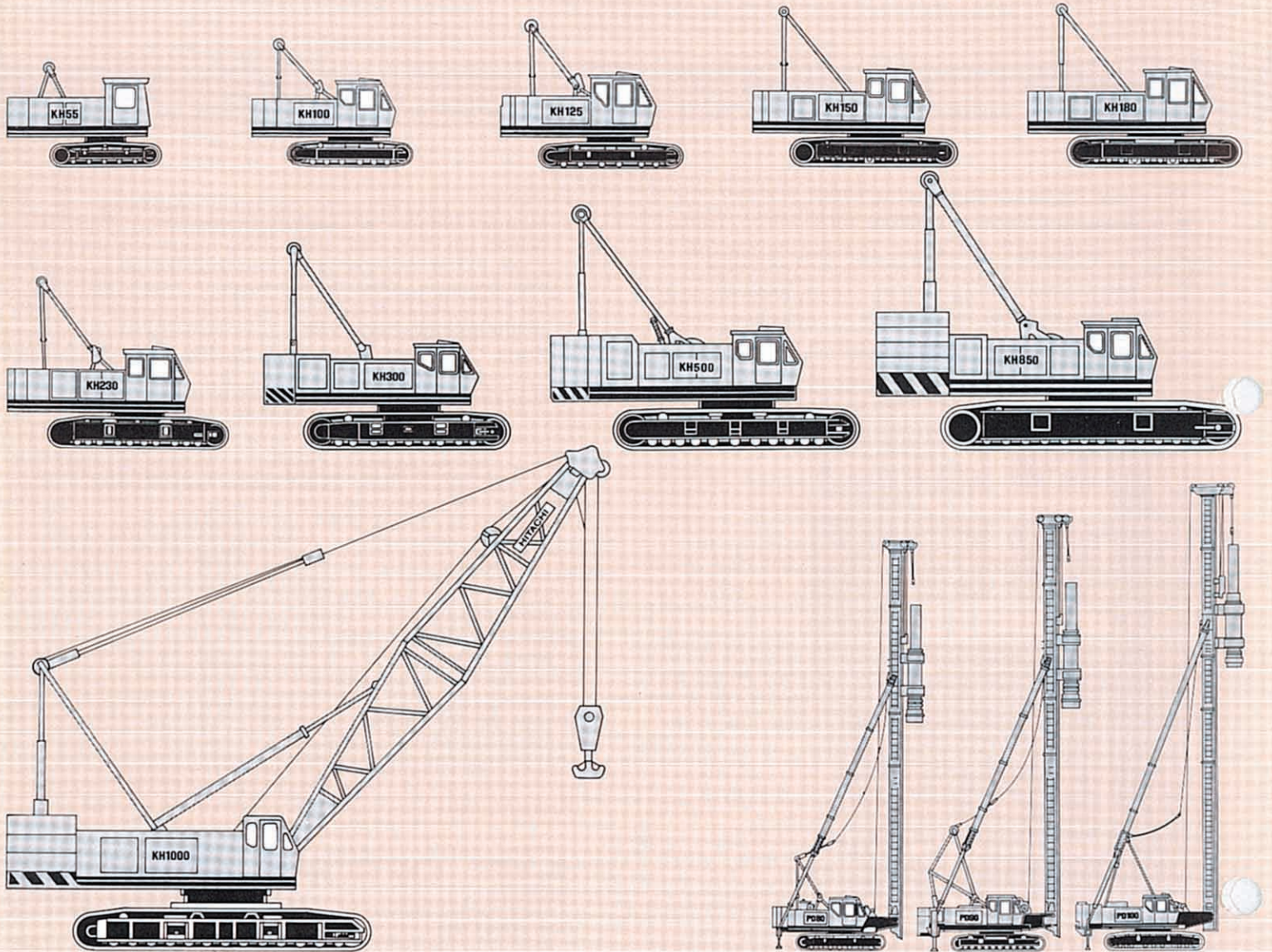

These specifications are subject to change without notice.

## Hitachi Construction Machinery Co., Ltd.

Head Office: Nippon Bldg., 6-2, 2-chome, Ohtemachi,  
Chiyoda-ku, Tokyo 100, Japan

Telephone: Tokyo (03) 3245-6361

Facsimile: Tokyo (03) 3246-2606

Telex: J 32539 HITACONJ

Cable Address: "TOKHITACHIENKI"