







# SPB209CP

|   |                        |   |   |
|---|------------------------|---|---|
|  LxWxH | 2500x770x1600 mm       |   |   |
|        | 3000 x 3000 mm         |   |   |
|        | kg                     |   |   |
|        | SPB209CP               | 1450  |   |
|        | /                      | 0   |   |
|        | 2T-D7                  | 20  |   |
|        | PP400-4DX<br>PP220-4DX | 45  |   |
|        | JIB800GX               | 20  |   |
|        | YAMAHA MZ 360          |  |  |
|        | 1                      | kW  | 7,6kW<br>10,4Hp   |



|   |        |
|---|--------|
|  | 990 Kg |
|  | 6,5 m  |
|  | 7,5 m  |

|   |        |   |   |
|---|--------|---|---|
|  | 495 kg |  | 53 m - Ø 6 mm   |
|   |        |   | 15,1 - 31,8 m/min   |
|  | 990 Kg | 2   |  -22 m |
|  | 495 Kg | 1   |  -46 m |





1,9-6,1 m 40 sec.

0°/75° 24 sec.

280° 1,0 rpm

|   |                            |
|---|----------------------------|
|  | 4 kW - 3F<br>400 VAC 50 Hz |
|   | 4 kW - 1F<br>220 VAC 60 Hz |

 1050 kg

|   |                         |   |             |
|---|-------------------------|---|-------------|
|  | 0,40 Kg/cm <sup>2</sup> |  | 1,7 Km/h    |
|  | 20°                     |  | 770-1060 mm |

- BPI
- CCI
- SCI
- A2B
- DTC

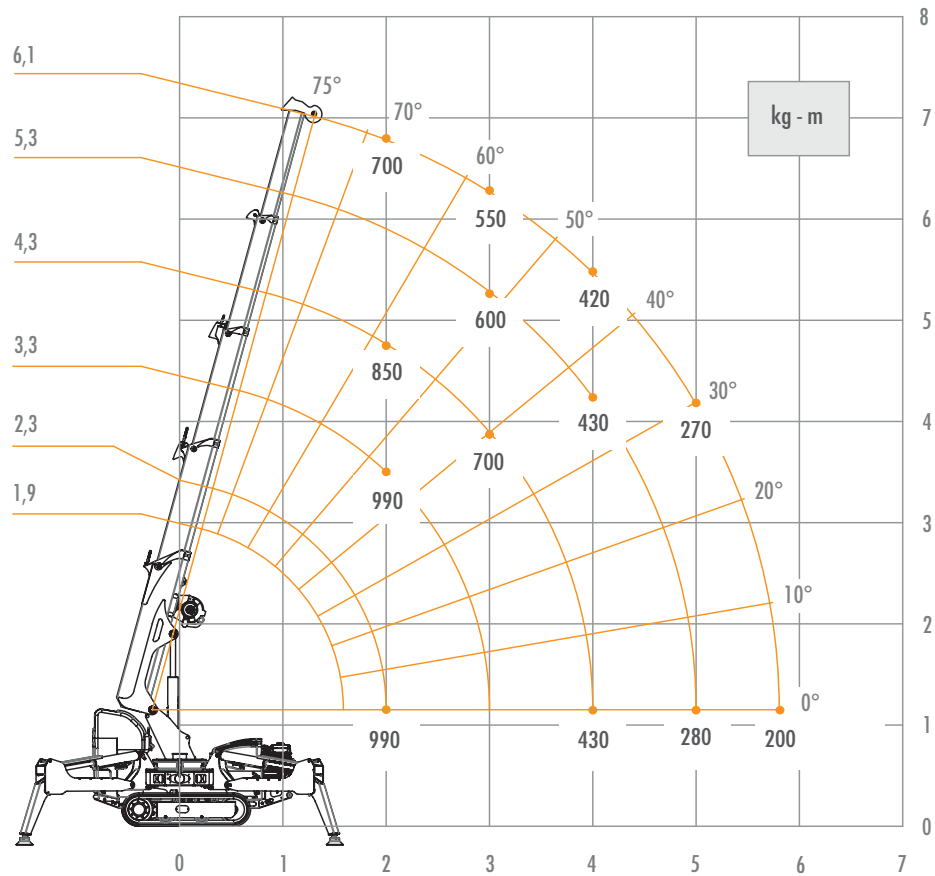

DISPLAY 3,5"



**JIB800GB**

MAX 800 Kg



MAX 7,5 m  
MAX 700 kg

MAX 6,5 m  
MAX 100 kg

