

General Specifications

Link-Belt® 22-Ton (19.95 metric ton)

Hydraulic self-propelled crane GENERAL INFORMATION ONLY

HSP-22

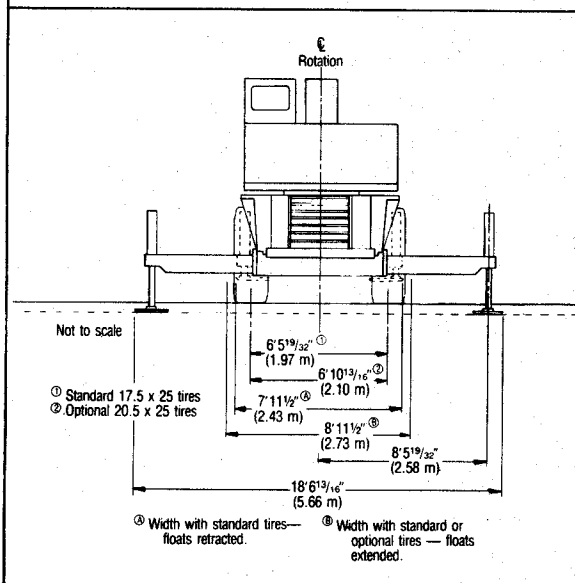
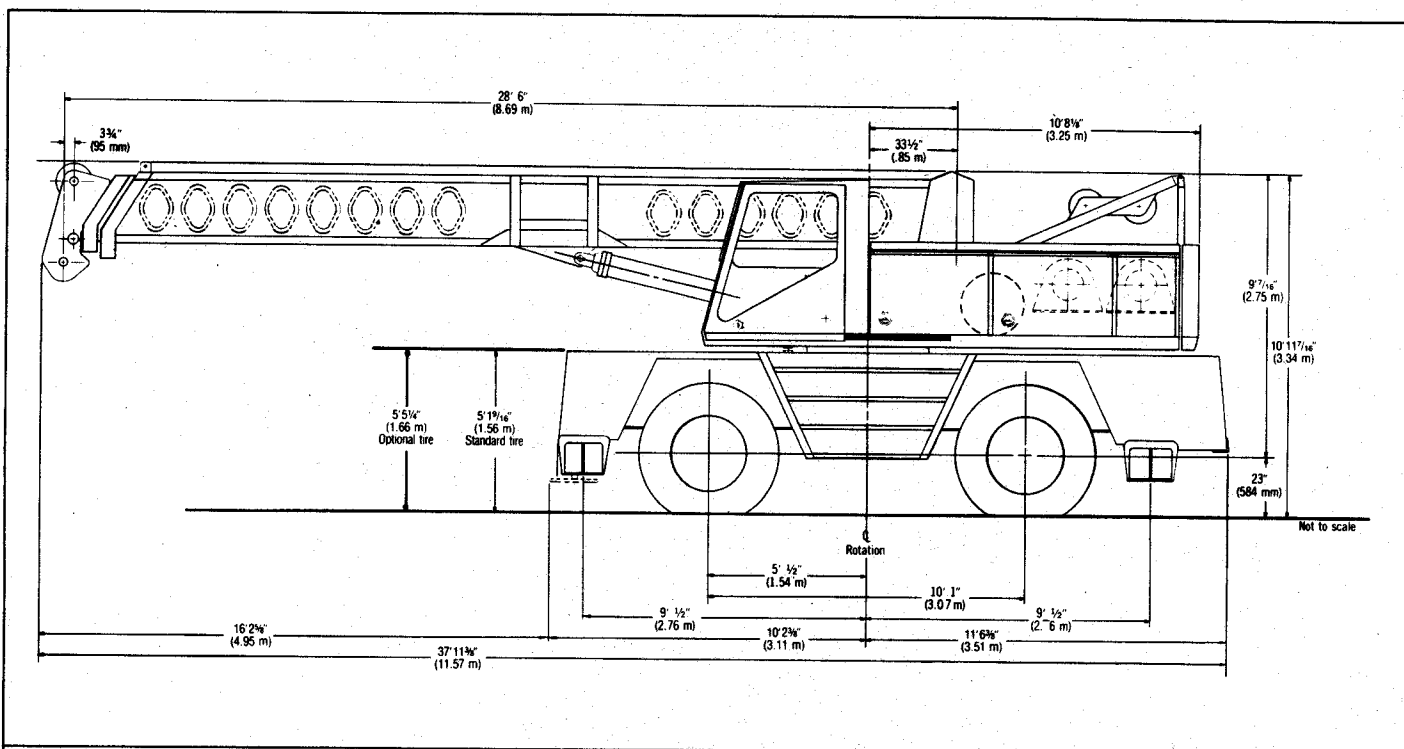

General dimensions	Feet	meters
Overall width [ⓐ]	—	—
— with standard tires	7' 11 1/2"	2.43
— with optional tires	8' 8 1/8"	2.64
Tailswing of counterweight	11' 2 5/8"	3.42
Minimum ground clearance	—	—
— with standard tires	9 11/16"	.25
— with optional tires	13 1/4"	.34
Ground clearance — on outriggers —	—	—
between tires and ground:	—	—
— with standard tires	5 3/4"	.35
— with optional tires	2 7/8"	.07
Wheelbase	10' 1"	3.07

[ⓐ]Outriggers retracted

GENERAL INFORMATION ONLY

Mounting —

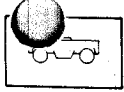

Type —

FMC self-propelled; 4 x 4 drive, 8'0" (2.44 m) wide, 121" (3.07 m) wheelbase.

Frame — Welded plate, box section construction between outriggers, all alloy steel; integral outrigger boxes.

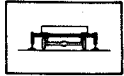

Outriggers —

Power hydraulic beams and jacks with 19½" floats; jacks equipped with check valve. Controls located in crane operator's cab.

Axles — Rockwell-Standard PSM 826 drive/steer axles with high traction differential in both front and rear axles. Rear axle disconnect at rear of transmission.

Suspension — Three-point; front axle bolted to frame, rear axle pin-mounted on bronze bushings to permit maximum 10" (.25 m) vertical oscillation. Automatic hydraulic oscillation lockout for stable lifting "on tires" over side and rear; manual axle oscillation lockout release.



Wheels and tires —

Planetary drives at each wheel. Tires — 17.5 x 25 (16-ply rating) standard; 20.5 x 25 (20-ply rating) optional.

Brakes — Rockwell-Standard 4-wheel air brakes with spring applied, air released emergency and parking brake chambers on all four wheels.



Steering —

Full power hydraulic; pump mounted directly on transmission; 14" (.36 m) diameter steering wheel. Two or four wheel, plus crab, steering standard.

Axle loadings — Basic boom retracted, hook block at bumper, and counterweight on machine:

Machine	Gross weight		Upper facing front				Upper facing rear			
			Front axle		Rear axle		Front axle		Rear axle	
	Lbs.	kgs.	Lbs.	kgs.	Lbs.	kgs.	Lbs.	kgs.	Lbs.	kgs.
1 drum	48,283	21 901	24,118	10 940	24,165	10 961	18,900	8 573	29,383	13 328
2 drum	48,497	21 998	24,393	11 065	24,104	10 934	18,940	8 546	29,657	13 452

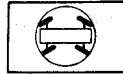

Turning radius —

Measured from center of turn to centerline of outermost tire. Two-wheel steer — 28'6" (8.68 m); four-wheel steer — 17'1" (5.21 m).

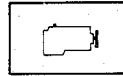

Engine —

General Motors 4-53 diesel; 4 cylinder, 2 cycle, 3⅞" (98.43 mm) bore, 4½" (114.30 mm) stroke, 212 cu. in. (3 478 cm³) displacement. Maximum brake h.p. — 136 @ 2,800 r.p.m. governed load speed; peak torque — 282 ft. lbs. (39.0 kgm) @ 1,800 r.p.m. Farr dry type air cleaner. Crankcase capacity — 3.5 gallons (13.25 liters).

Air compressor — 12 c.f.m. (.34 m³/min.) Bendix-Westinghouse.

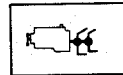

Hydraulic pump drive —

Triple gear-type pump located on transmission supplies hydraulic oil flow for crane upper functions. Mechanical jaw-type pump drive disconnect clutch is air-actuated by electrical solenoid control switch in operator's cab.

Transmission — Allison TT-2221-1 powershift with TT-270 two stage, twin-turbine torque converter.

Travel Speeds, Gradeabilities and maximum tractive efforts — (see charts)

Standard tires					
Transmission range	Maximum speed		Maximum grade-ability ①	Maximum tractive effort @ stall	
	Mph	km/h		Pounds	kilograms
Hi	22	35.4	21.3%	11,040	5 008
Low	6	9.7	73.5	41,960	19 033
Rev	8	12.9	73.5	30,910	14 021

Optional tires					
Transmission range	Maximum speed		Maximum grade-ability ①	Maximum tractive effort @ stall	
	Mph	km/h		Pounds	kilograms
Hi	25.5	41.0	18 %	9,510	4 314
Low	7.0	11.3	73.5	36,140	16 393
Rev	9.3	15.0	62.1	26,630	12 079

① Limited by surface condition

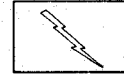

Electrical system —

Standard: 12 volt — 42 amp alternator, one 12 volt — 900 CCA battery for 12 volt start and 12 volt operation, low air pressure buzzer, and vehicle horn.

Optional: 12 volt — 42 amp alternator, two 12 volt — 900 CCA batteries for 24 volt start and 12 volt operation, four sealed beam headlights (two front, two rear) stop, turn, and tail lights, and back-up lights.

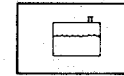

Fuel tank —

68 gallon (257.38 liters) capacity.

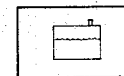

Hydraulic sump tank —

101 gallon (382.28 liters) capacity. Tank equipped with three 10 micron filters and 25 p.s.i. (172.38 kPa) bypass valve; baffled for strength and oil deaeration and cooling; pressurized to 6 p.s.i. (41.37 kPa) positive air pressure.

Accessories — Standard; skid-resistant finish on deck, cab access ladder and storage compartment, fenders with clearance lights and other lights as described under electrical system, towing shackles, spare tire and rim.

Rotating joint — FMC 10-way rotating joint provides passage of hydraulic, air, and electrical lines between mounting and revolving upperstructure.

Revolving upperstructure — GENERAL INFORMATION ONLY

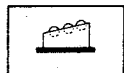

Frame —

All-welded, in-line bores.

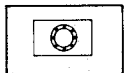

Turntable bearing —

Inner race bolted to upper; outer race, with integral, external tooth swing gear, bolted to mounting deck.

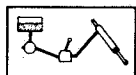

Hydraulic system —

Triple gear-type pump (driven off transmission) supplies hydraulic oil flow for three circuits. First 21 g.p.m. (79.49 liters/min.) section supplies flow for outrigger beam/jack control and boom middle section telescope. Second 21 g.p.m. (79.49 liters/min.) section is for swing and boom tip telescope. The third, a 50 g.p.m. (189.25 liters/min.) section for boom hoist and main rear and optional auxiliary front hoist drums. Two 21 g.p.m. (79.49 liters/min.) circuits equipped with relief valves set at 2,500 p.s.i. (17 MPa); 50 g.p.m. circuit equipped with relief valve set at 2,800 p.s.i. (19 MPa). Oil cooler mounted behind engine radiator.

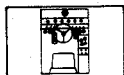

Control system —

Swing, boom telescope, hoist motors and boomhoist functions controlled by levers in cab directly in front of operator. Push-pull type cables transmit force from control lever to the main hydraulic control valves. Foot peds also provided for control of boomhoist, service and swing brakes. Electrical switches control hydraulic outrigger beams and jacks, cylinders, pump disconnect, throttle lock, 2-wheel, 4-wheel, or "crab" steering, axle oscillation lockout over-ride, reserve air supply, lights, windshield wiper, and defroster.

Two-speed load hoist system — Standard; rear drum; auxiliary front drum, for rear main hoist drum only; hoist drum is direct driven by bi-directional, tandem gear-type hydraulic motor. High speed is obtained by depressing a button on swing lever which actuates an electrical solenoid valve that diverts the oil through only one section of the hydraulic motor. For power load lowering, a holding valve restricts the outlet side of the hydraulic pressure to reverse the motor and power the load down. An automatic, spring applied, hydraulically released brake is mounted on the hydraulic motor shaft.

Drums wire rope capacity — Front and Rear; 529' (161.24 m) of 9/16" (14.31 mm) rope.

Drum rotation indicators — Standard with either load hoist system.

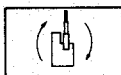

Swing system —

Consists of bi-directional hydraulic motor, mounted to speed reducers, vertical swing shaft and swing pinion; 360° rotation right or left.

Swing speed — 3.0 r.p.m.

Swing brake — Manually applied and released; two-shoe brake and brake drum mounted on speed reducer input shaft.

Swing lock — Standard; manually controlled, two-position, pin type swing lock permits locking upper in travel position with boom centered directly over either end of machine. 360° house lock permits upper to be locked in any position — optional.

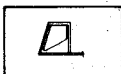

Operator's cab —

Offset; key locked door on sliding track with automatic lock to hold door open. Cab insulated from vibration by rubber mounts. Neoprene seal between platform and cab provides insulation from weather and sound. Windows — removable front, sliding rear, fixed side, and hinged rooftop. All windows and door equipped with safety glass panels. Standard equipment — upholstered bucket seat with head rest and seat belt, 5 lb. (2.27 kg) dry chemical fire extinguisher, defroster fan and windshield wiper; heater optional.

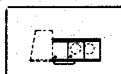

Machinery cab —

Equipped with key locked doors, vented for cooling; top removable in two sections.

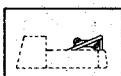

Fleeting sheaves —

Transmit the wire rope over the base of the boom at low angles. 10 5/8" (.27 m) root diameter with bronze bushings.

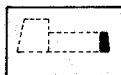

Counterweight —

Machine with one hoist drum, 5,850# (2,654 kg); with two hoist drums, 5,000# (2,268 kg).

Attachment —



Boom —

28'6" (8.69 — 21.34 m) length. Fabricated box type; machined T-1 steel corner angles, diamond shaped depressions in side plates for lateral stiffness. Three-section power boom with two double-acting (extend/retract) telescoping cylinders. Boom equipped with replaceable, synthetic, rocker support shoes at top and bottom of boom center and tip sections, and at sides of base and center boom sections. Bumper pads at top side of base and center sections minimize boom section springing upward due to quick load release.

Deflector roller — One load hoist wire rope deflector roller, mounted on anti-friction bearings, mounted on lower top side of boom base section.

Boom top section — Hammerhead design, can be equipped to handle up to 8 parts of wire rope with, 3, 4 or 5 head sheaves and dead end link. Two idler sheaves permit reeving of both drums. All sheaves 10 5/8" (.27 m) root dia. mounted on anti-friction bearings.

Auxiliary lifting sheave — Optional; single 10 5/8" (.27 m) root diameter sheave, mounted on anti-friction bearings; for reeving or two parts of load hoist wire rope off main rear, or optional auxiliary, front drum. Sheave mounting bracket bolted to boom head — does not interfere with stowing of jib or use of main boom load sheaves for multiple rope reevings.

Boom length indicator — Optional.

Boom angle indicator — Standard.



Fly —

Optional; 25' (7.62 m) long, one-piece lattice type.

Optional; 25' (7.62 m) long, two-piece lattice type. Consists of a 5' (1.52 m) folding base section plus a 20' (6.10 m) lattice top section.

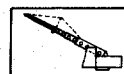

Jib —

Optional; 45' (13.72 m) long, three-piece lattice type. Consists of a 5' (1.52 m) folding base section, one 20' (6.10 m) straight lattice extension, and 20' (6.10 m) lattice top section.

Jib point sheave — Standard; single 11 $\frac{7}{8}$ " (.30 m) root diameter for 45' (13.72 m) jib. Sheave mounted on anti-friction bearings.

Fly point sheave — Standard; single 11 $\frac{7}{8}$ " (.30 m) root diameter for 25' (7.62 m) 2-piece fly, and 10 $\frac{5}{8}$ " (.27 m) root diameter for 25' (7.62 m) one-piece fly. Sheaves mounted on anti-friction bearings.

Hook block — Optional.

Weighted ball swivel hook — Optional.

Wire rope — $\frac{9}{16}$ " (14 mm) dia. Type "N"; 6 x 25 (6 x 19 class) filler wire extra improved plow steel, preformed, independent wire rope core, right lay, regular lay.

Available maximum line pull — developed by machinery with first layer of wire rope, not based on wire rope strength.

Rear main and front auxiliary drum		
	Pounds	kilograms
Standard speed	9,810	4 450
High speed	5,010	2 273

GENERAL INFORMATION ONLY

Permissible line speeds and pulls — based on $\frac{9}{16}$ " (14 mm) diameter Type "N" wire rope strength.

Layers of wire rope	Drum speed	Rear main and front auxiliary drum [Ⓞ]			
		Line speed		Line pull	
		F.p.m.	meters/min.	Pounds	kilograms
First	Standard	161	49.07	8,920	4 046
	High	287	87.48	5,010	2 273
Fifth	Standard	218	66.45	6,570	2 980
	High	390	118.87	3,690	1 674

[Ⓞ]Drum capable of spooling six layers of wire rope, but sixth layer is not recommended for load handling.

We are constantly improving our products and therefore reserve the right to change designs and specifications.



FMC Corporation Crane and Excavator Division World Headquarters Cedar Rapids Iowa 52406
 Plants in: Cedar Rapids Iowa (2) • Lexington and Bowling Green Kentucky • Ontario Canada • Milan Italy • Queretaro Mexico & Nagoya Japan (under license)

The HSP-22 maximum boom/jib tip height is 121' (36.88 m)

GENERAL INFORMATION ONLY

Convenient storage of fly/jib in travel position

The HSP-22 lattice fly or jib options are conveniently stored on the side of boom in the travel position. A minimal amount of time is required to assemble the boom extensions into a working position. The HSP-22 offers exceptional boom/fly/jib tip heights, reach, and lifting capacity.

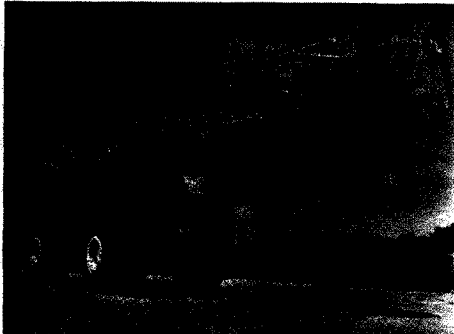

Fly in stored position

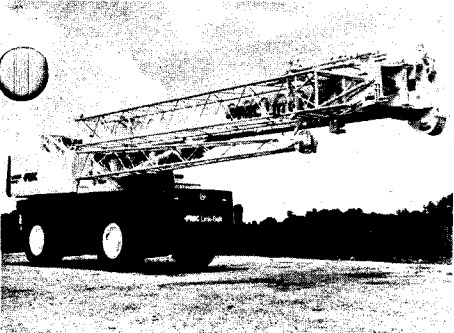

Jib in stored position

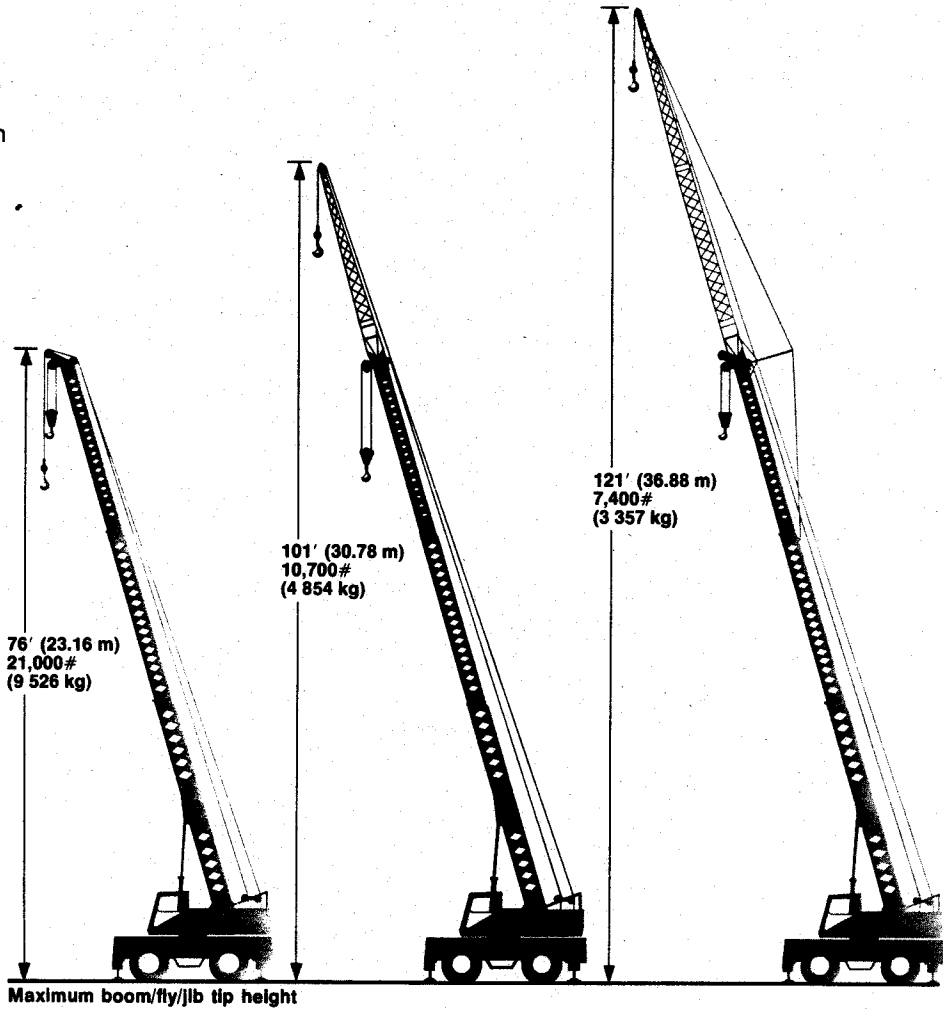

The HSP-22 features:

Carrier

- FMC designed and manufactured
Benefit: *Dependability and performance*
- Flat deck carrier
Benefit: *Added stability and unobstructed vision*
- Steering wheel coordinated steering mode
Benefit: *Added safety, maneuverability, and convenience*

Upperstructure

- Low profile frame
Benefit: *Lower center of gravity*
- Large 2-speed hoist drums
Benefit: *Decrease cycle times*
- Luxurious operator's cab
Benefit: *Increased operator efficiency*

Attachment

- FMC exclusive boom design
Benefit: *Dependable and reliable*
- Swing around fly and jib section
Benefit: *Easily assembled, exceptional capacities*
- 121' (36.88 m) boom/jib tip height
Benefit: *Gives extra added working range capability*

We are constantly improving our products and therefore reserve the right to change designs and specifications.

Corporation Crane and Excavator Division World Headquarters Cedar Rapids Iowa 52406
Plants in: Cedar Rapids Iowa (2) • Lexington & Bowling Green Kentucky • Ontario Canada • Milan Italy • Queretaro Mexico & Nagoya Japa (under license)