

Hydraulic Crawler Crane

**CKE**

**600G**

Model : CKE600G

Max. Lifting Capacities : **60 t x 3.0 m**

Max. Crane Boom Length : **51.8 m**

Max. Fixed Jib Combination: **39.6 m + 18.3 m 42.7 m + 12.2 m**

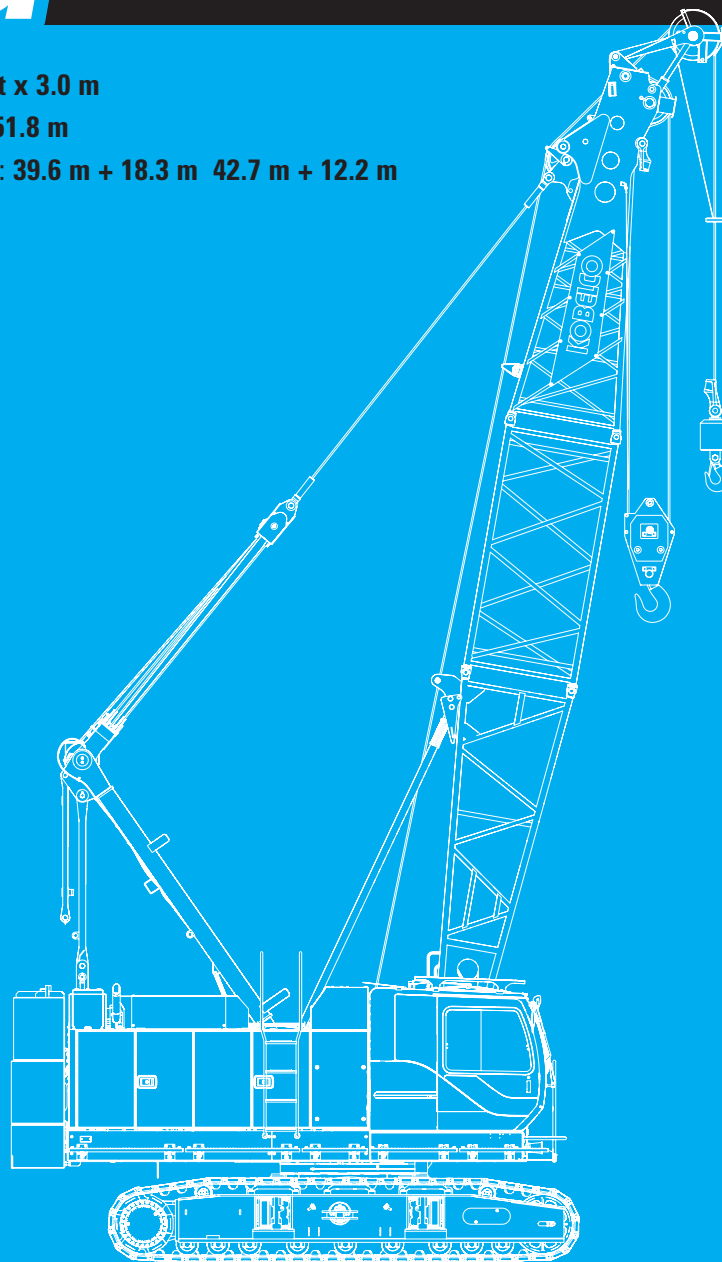

**KOBELCO**



# **CKE600G**

## **CONTENTS**

**3**

**SPECIFICATIONS**

**5**

**GENERAL DIMENSIONS**

**6**

**BOOM AND JIB ARRANGEMENTS**

**7**

**WORKING RANGES**

**10**

**SUPPLEMENTAL DATA**

**11**

**LIFTING CAPACITIES**

**13**

**TRANSPORTATION PLAN**

**17**

**PARTS AND ATTACHMENTS**

# SPECIFICATIONS



## Power Plant

**Model:** HINO J08E-UV

**Type:** 4 cycle, water-cooled, vertical in-line 6, direct injection, turbo-charger, intercooler

Complies with NRMM (Europe) Stage IIIB and US EPA Tier Interim Tier 4

**Displacement:** 7.684 liters

**Rated power:** 213 kW/2100 min<sup>-1</sup> (285 HP/2,100 rpm)

**Max. Torque:** 1,017 N·m/1,600 min<sup>-1</sup>

**Cooling System:** Water-cooled

**Starter:** 24V-5kW

**Radiator:** Corrugated type core, thermostatically controlled

**Air cleaner:** Dry type with replaceable paper element

**Throttle:** Twist grip type hand throttle, electrically actuated

**Fuel filter:** Replaceable paper element

**Batteries:** Two 12V x 136 Ah/5HR capacity batteries, series connected

**Fuel tank capacity:** 400 liters



## Hydraulic System

**Main pumps:** 3 variable displacement piston pumps

**Control:** Full-flow hydraulic control system for infinitely variable pressure to all winches, propel and swing. Controls respond instantly to the touch, delivering smooth function operation.

**Cooling:** Oil-to-air heat exchanger (plate-fin type)

**Filtration:** Full-flow and bypass type with replaceable element

**Max. relief valve pressure:**

**Load hoist, boom hoist and propel system:**

4,626 psi (31.9 MPa)

**Swing system:** 27.5 MPa (3,989 psi)

**Control system:** 5.4 MPa (783 psi)

**Hydraulic Tank Capacity:** 440 liters (116.2 US Gal)



## Boom Hoisting System

Powered by a hydraulic motor through a planetary reducer.

**Brake:** A spring-set, hydraulically released multiple-disc brake is mounted on the boom hoist motor and operated through a counter-balance valve.

**Drum Lock:** External ratchet for locking drum

**Drum:** Single drum, grooved for 16mm dia. wire rope

**Line Speed:** Single line on first drum layer

**Hoisting/Lowering:** 70 to 2 m/min

**Diameter of wire rope**

**Main winch:** 22 mm x 180 m (7/8 in. x 590 ft.)

**Aux. winch:** 22 mm x 130 m (7/8 in. x 673 ft.)

**Third winch:** 22 mm x 145 m (7/8 in. x 476 ft.)

**Boom hoisting/lowering:** 16 mm x 150 m (5/8 in. x 492 ft)

**Boom guy line:** 30 m (1-3/16 in.)

**Boom backstops:** Required for all boom length



## Load Hoisting System

Front and rear drums for load hoist powered by a hydraulic variable plunger motors, driven through planetary reducers.

**Negative Brake:** A spring-set, hydraulically released multiple-disc brake is mounted on the hoist motor and operated through a counter-balance valve. (Positive free fall brake is optional)

**Drum Lock:** External ratchet for locking drum

**Drums:**

**Front Drums:**

550 mm (1 ft 9-21/32 inch) P.C.D x 545 mm (1 ft 9-15/32 inch) wide drum, grooved for 22 mm (7/8 inch) wire rope. Rope capacity is 180 m (590 ft) working length and 335 m (1099 ft) storage length.

**Rear Drum:** 550 mm (1 ft 9-21/32 inch) P.C.D x 545 mm (1 ft 9-15/32 inch, grooved for 22 mm (7/8 inch) wire rope. Rope capacity is 130 m (426 ft) working length and 335m (1,099 ft) storage length.

**Line Speed:** Single line on first drum layer

**Hoisting/lowering:** 120 to 3 m/min

**Line Pull:**

**Max. Line Pull (Single Line):** 153 kN (34,400 lbs)

**Rated Line Pull:** 78.5 kN (17,000 lbs)



## Swing System

Swing unit is powered by hydraulic motor driving spur gears through planetary reducers (2 set), the swing system provides 360° rotation.

**Swing parking brakes:** A spring-set, hydraulically released multiple-disc brake is mounted on swing motor.

**Swing circle:** Single-row ball bearing with an integral internally cut swing gear.

**Swing lock:** Manually, four position lock for transportation

**Swing Speed:** 4.5 min<sup>-1</sup> (rpm)



## Upper Structure

Torsion-free precision machined upper frame. All components are located clearly and service friendly. Engine will with low noise level.

**Counter weight:** 13.0 ton



## Cab & Control

Totally enclosed, full vision cab with safety glass, fully adjustable, high backed seat with a headrest and armrests, and intermittent wiper and window washer (skylight and front window).

**Cab fittings:**

Air conditioner, convenient compartment (for tool), cup holder, ashtray, cigarette lighter, sun visor, roof blind, tinted glass, floor mat, footrest, and shoe tray

**Controls:**

Four adjustable levers for front drum, rear drum, boom drum and swing controls.

**Lower Structure**

Steel-welded carbody with axles. Crawler assemblies are designed with quick disconnect feature for individual removal as a unit from axles. Crawler belt tension is maintained by hydraulic jack force on the track adjusting bearing block.

**Crawler drive:** Independent hydraulic propel drive is built into each crawler side frame. Each drive consists of a hydraulic motor propelling a driving tumbler through a planetary gear box. Hydraulic motor and gear box are built into the crawler side frame within the shoe width.

**Crawler brakes:** Spring-set, hydraulically released parking brakes are built into each propel drive.

**Steering mechanism:** A hydraulic propel system provides both skid steering (driving one track only) and counter-rotating steering (driving each track in opposite directions).

**Track rollers:** Sealed track rollers for maintenance-free operation.

**Shoe (flat):** 925 mm wide each crawler

**Max. gradeability:** 40%

**Weight**

Including upper and lower machine, 13.0 ton counterweight and basic boom, hook, and other accessories.

**Weight:** 46.1 ton

**Ground pressure:** 63.1 kPa

**Attachment****Boom & Jib:**

Welded lattice construction using tubular, high-tensile steel chords with pin connection between sections.

**Boom and Jib length**

	Min. Length (Min. combination)	Max. Length (Min. combination)
Crane Boom	9.1 m	51.8 m
Fixed jib	30.5 m + 6.1 m	42.7 m + 12.2 m, 39.6 m + 18.3 m

**Main Specifications (Model: CKE600G)**

<b>Crane Boom</b>	
Max. Lifting Capacity	60 t x 3.0 m
Max. Length	51.8 m
<b>Fixed Jib</b>	
Max. Lifting Capacity	7.0 t x 12.0 m
Max. Combination	39.6 m + 18.3 m
<b>Main &amp; Aux. Winch</b>	
Max. Line Speed (1st layer)	120 m/min
Rated Line Pull (Single line)	78.5 kN {8.0 tf}
Wire Rope Diameter	22 mm x 180 m
Wire Rope Length	180 m (Main), 130 m (Aux.)
Brake Type	Wet-type multiple disc brake (Optional)
<b>Working Speed</b>	
Swing Speed	4.5 min <sup>-1</sup> {rpm}
Travel Speed	2.3/1.5 km/h
<b>Power Plant</b>	
Model	HINO J08E-UV
Engine Output	213 kW/2100 min <sup>-1</sup>
Fuel Tank	400 liters

<b>Hydraulic System</b>	
Main Pumps	3 variable displacement
Max. Pressure	31.9 Mpa {325 kg/cm <sup>2</sup> }
Hydraulic Tank Capacity	440 liters
<b>Weight</b>	
Operating Weight	46.1 t * <sup>1</sup>
Ground Pressure	63.1 kPa
Counterweight	13,030 kg
Transport Weight	31,430 kg * <sup>2</sup>

Units are SI units. { } indicates conventional units.

Line speeds in table are for light loads. Line speed varies with load.

\*<sup>1</sup> Including upper and lower machine, 13.0 ton counterweight, basic boom, hook, and other accessories.

\*<sup>2</sup> Base machine with boom base, gantry, crawlers, and wire ropes (front/boom hoist)

# GENERAL DIMENSIONS

(Unit: mm)

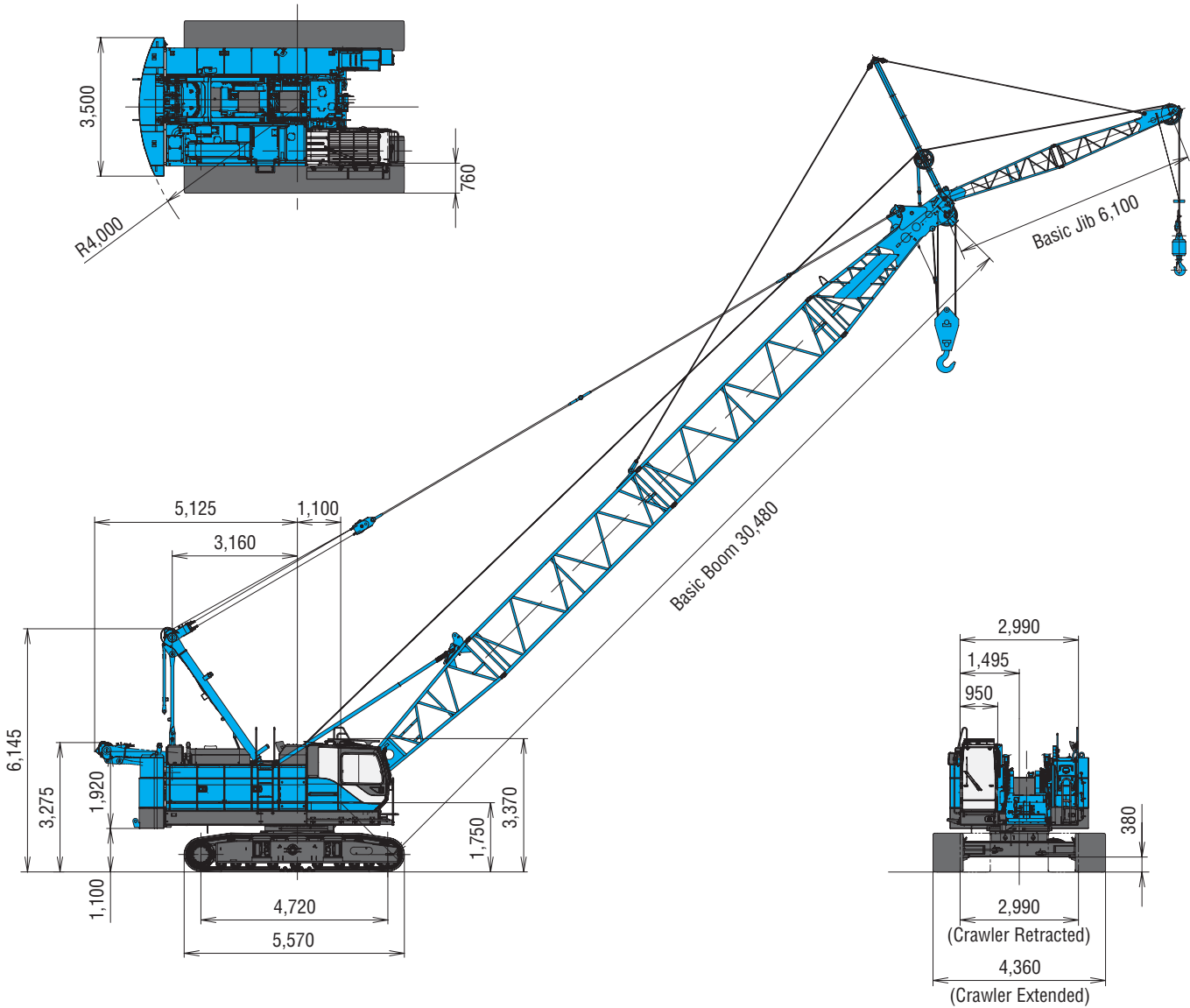

## Limit of Hook Lifting

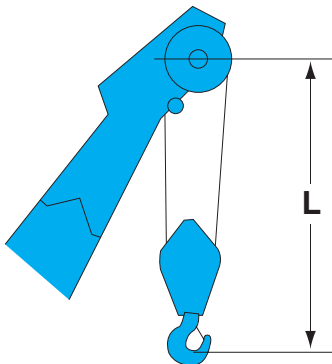

Hook	L
60 t hook	3.9 m
32 t hook	3.7 m
19 t hook	3.6 m

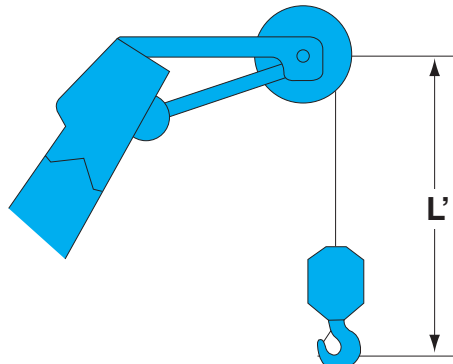

Hook	L'
6.6 t ball hook	3.0 m

# BOOM AND JIB ARRANGEMENTS

## Crane Boom Arrangements

Boom length m (ft)	Boom arrangement
9.1 (30)	
12.2 (40)	
15.2 (50)	 
18.3 (60)	 
21.3 (70)	  
24.4 (80)	  
27.4 (90)	  
30.5 (100)	 

Boom length m (ft)	Boom arrangement
33.5 (110)	 
36.6 (120)	
39.6 (130)	   
42.7 (140)	
45.7 (150)	 
48.8 (160)	
51.8 (170)	

Symbol	Boom Length	Remarks
	5.2 m	Boom Base
	3.9 m	Boom Top
	3.0 m	Insert Boom
	6.1 m	Insert Boom
	9.1 m	Insert Boom
	9.1 m	Insert Boom with lug

↗ mark shows the guy line installing position when the fixed jib is used.

^ mark shows the standard boom arrangement which enables each boom length of less than that boom length to be configured.

## Fixed Jib Arrangements

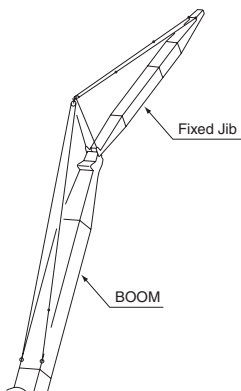

Crane boom length	Jib length m (ft)	Jib arrangement
30.5 m ~ 42.7 m	6.1 (20)	
30.5 m ~ 39.6 m	12.2 (40)	
	18.3 (60)	

Symbol	Jib Length	Remarks
	3.0 m	Jib Base
	3.0 m	Jib Top
	6.1 m	Insert Jib

# WORKING RANGES

## Crane Boom

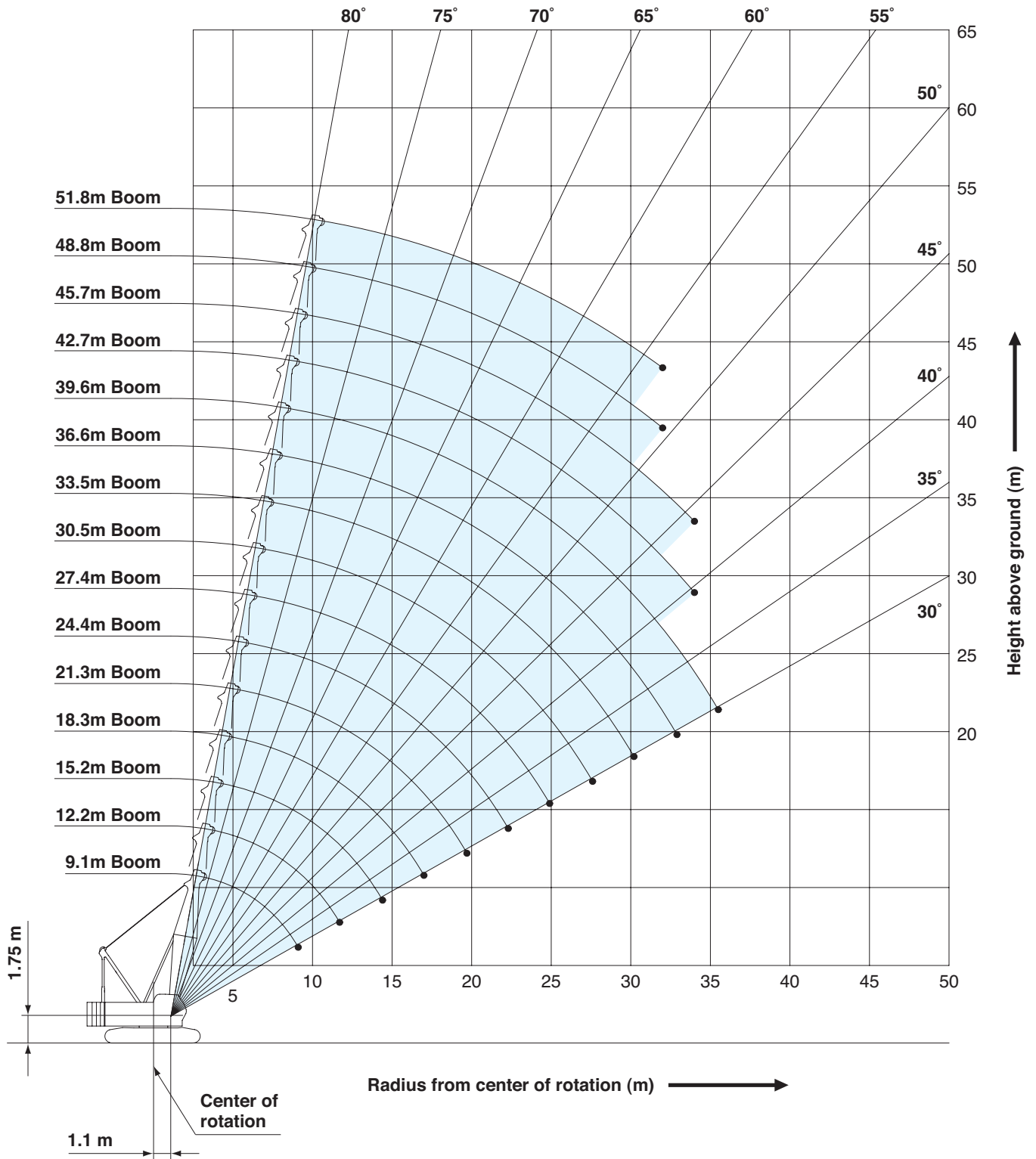



# Fixed Jib 10°

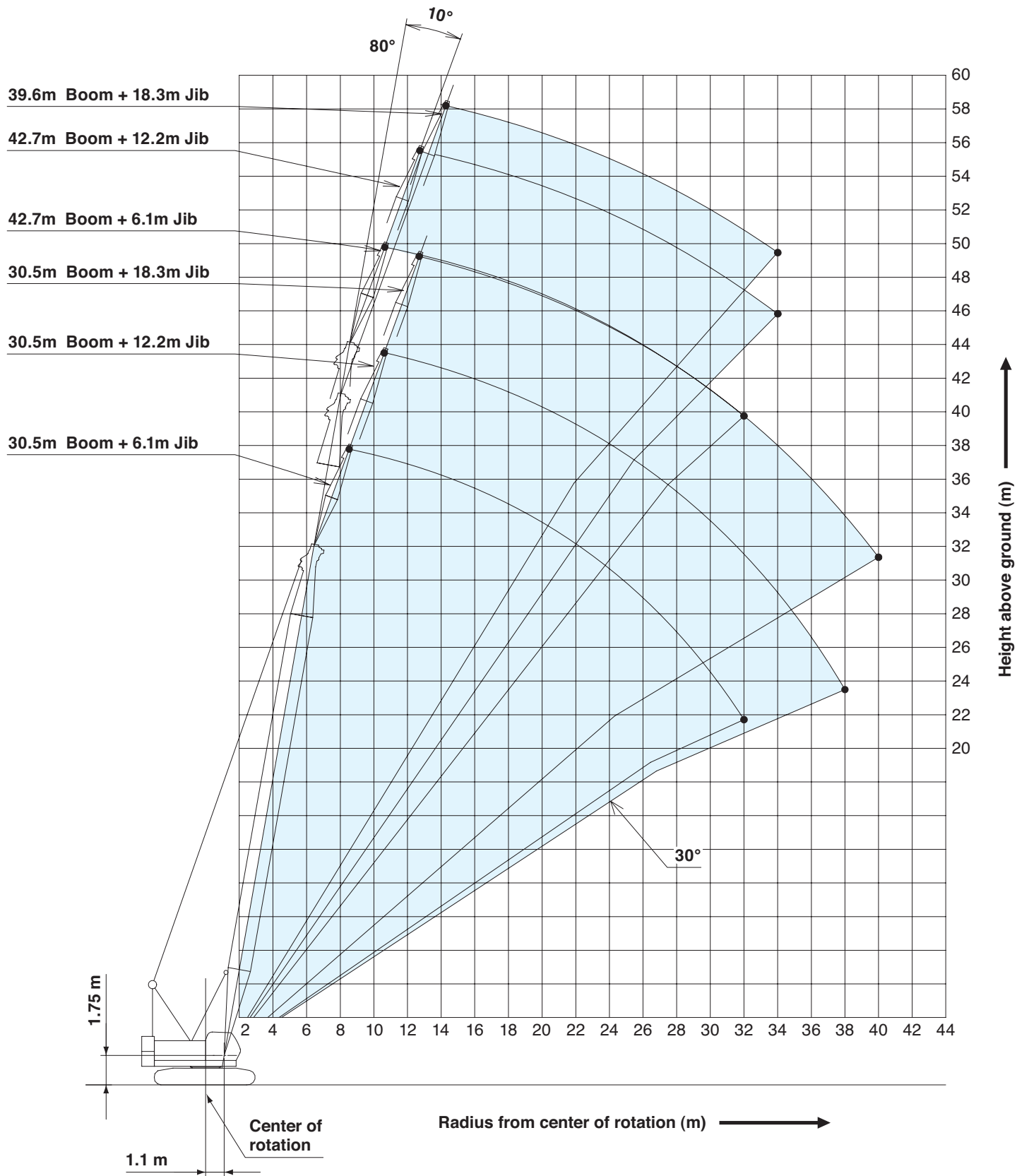



- Ratings according to EN13000.
- Operating radius is the horizontal distance from centerline of Rotation to a vertical line through the center of gravity of the load.
- Deduct weight of hook block (s), slings and all other load handling accessories from main boom ratings shown.
- Ratings shown are based on freely suspended loads and make no allowance for such factors as wind effect on lifted load, ground conditions, out-of-level, operating speeds or any other condition that could be detrimental to the safe operation of this equipment.  
The operator, therefore, has the responsibility to judge the existing conditions and reduce lifted loads and operating speeds accordingly.
- Ratings are for operation on a firm and level surface, up to 1 % gradient.
- At radii and boom lengths where no ratings are shown on chart, operation is not intended nor approved.
- Boom inserts and guy lines must be arranged as shown in the "operator's manual".
- Boom hoist reeving is 10 part line.
- Gantry must be in raised position for all conditions.
- Boom backstops are required for all boom lengths.
- The boom should be erected over the front of the crawlers, not laterally.
- Ratings inside of boxes  are limited by strength of materials.
- The minimum rated load is 1.0 (ton).
- Crawler frames must be fully extended for all crane operations.
- For the boom of 39.6 m (160 ft) length place blocking steel plates between the ends of the crawlers and the ground.
- For the combination of the boom of 39.6 m (130 ft) length and the jib of 18.3 m (60 ft) length or the boom of 42.7 m (140 ft) length and the jib of any length, place blocking steel plates between the ends of the crawlers and the ground.

## (Main boom)

- The total load that can be lifted is the value for weight of hook block, slings, and all other load handling accessories deducted from main boom ratings shown.

## (Main boom with auxiliary sheave frame)

- The total load that can be lifted is the value for weight of hook block (s), slings, and all other load handling accessories deducted from main boom with auxiliary sheave ratings shown.

## (Auxiliary sheave)

- The total load that can be lifted is the value for weight of hookblock (s), slings, and all other load handling accessories deducted from auxiliary sheave ratings shown.
- Boom lengths for auxiliary sheave mounting are 9.1 m to 48.8 m.

## (Main boom with fixed jib)

- The total load that can be lifted is the value for weight of hook block (s), slings, and all other load handling accessories deducted from main boom with fixed jib ratings shown.
- Only 19 t hook block can be used for main hook.

## (Fixed jib)

- The total load that can be lifted is the value for weight of hook block (s), slings, and all other load handling accessories deducted from fixed jib ratings shown.
- Boom lengths for fixed jib mounting are 30.5 m to 42.7 m. However, do not install 18.3 m jib to 42.7 m boom.

## Main hoist loads

No. of Parts of Line	1	2	3	4	5
Maximum Loads (kN)	69	137	206	275	343
Maximum Loads (t)	7.0	14.0	21.0	28.0	35.0

No. of Parts of Line	6	7	8	9
Maximum Loads (kN)	412	481	549	588
Maximum Loads (t)	42.0	49.0	56.0	60.0

## Auxiliary hoist loads

No. of Parts of Line	1
Maximum Loads (kN)	69
Maximum Loads (t)	7.0

Weight of hook block				
Hook Block	60 t	32 t	19 t	7.0 t Ball Hook
Weight (t)	0.7	0.5	0.4	0.16

Operation of this equipment in excess of rated loads or disregard of instruction voids the warranty.

# LIFTING CAPACITIES

 <b>Crane Boom Lifting Capacities</b> Counterweight: 11.0 t Unit: metric ton				
Working radius (m)	Boom Length (m)	9.1	Boom Length (m)	Working radius (m)
3.0		3.0m/60.0		3.0
3.5		52.6		3.5
4.0		42.2		4.0
4.5		34.2		4.5
5.0		28.6		5.0
5.5		24.6		5.5
6.0		21.5		6.0
7.0		17.2		7.0
8.0		14.2		8.0
9.0		12.1		9.0
10.0		9.1m/12.0		10.0
Reeves		9		Reeves

 <b>Crane Boom Lifting Capacities</b>																Counterweight: 13.0 t			
																Unit: metric ton			
Working radius (m)	Boom Length (m)	9.1	12.2	15.2	18.3	21.3	24.4	27.4	30.5	33.5	36.6	39.6	42.7	45.7	48.8	51.8	Boom Length (m)	Working radius (m)	
3.0		3.0m/56.0																	3.0
3.5		54.3	3.6m/50.0																3.5
4.0		45.9	43.3	4.1m/38.9															4.0
4.5		37.2	37.0	34.6	4.7m/30.9														4.5
5.0		31.2	31.1	30.3	28.7	5.2m/26.0													5.0
5.5		26.8	26.7	26.7	25.7	24.4	5.7m/22.3												5.5
6.0		23.5	23.4	23.3	23.2	22.1	21.1	6.2m/19.5	6.8m/16.9										6.0
7.0		18.7	18.7	18.6	18.6	18.5	17.8	17.1	16.4										7.0
8.0		15.6	15.4	15.4	15.3	15.3	15.2	14.7	14.1	8.0m/13.6	8.0m/13.1	8.4m/12.0	8.9m/10.8						8.0
9.0		13.3	13.1	13.1	13.0	12.9	12.9	12.8	12.4	11.9	11.5	11.1	10.7	9.4m/9.8	9.9m/8.9				9.0
10.0		9.1m/13.1	11.4	11.3	11.3	11.2	11.1	11.1	11.0	10.6	10.2	9.8	9.5	9.2	8.8	10.5m/8.0			10.0
12.0			11.8m/9.2	8.8	8.8	8.7	8.6	8.6	8.5	8.4	8.2	7.9	7.6	7.4	7.1	6.8			12.0
14.0				7.2	7.1	7.0	7.0	6.9	6.8	6.7	6.7	6.5	6.3	6.0	5.8	5.5			14.0
16.0				14.4m/7.0	6.0	5.9	5.8	5.7	5.6	5.5	5.5	5.3	5.2	5.0	4.8	4.5			16.0
18.0					17.1m/5.5	4.9	4.8	4.8	4.7	4.6	4.5	4.4	4.3	4.2	4.0	3.8			18.0
20.0						19.7m/4.3	4.1	4.0	3.9	3.8	3.8	3.6	3.6	3.5	3.3	3.1			20.0
22.0							3.5	3.5	3.3	3.2	3.2	3.0	3.0	2.9	2.7	2.6			22.0
24.0							22.3m/3.4	3.0	2.8	2.7	2.7	2.5	2.5	2.4	2.2	2.1			24.0
26.0								25.0m/2.8	2.4	2.3	2.3	2.1	2.1	1.9	1.8	1.7			26.0
28.0									27.6m/2.2	2.0	1.9	1.8	1.7	1.6	1.5	1.3			28.0
30.0										1.7	1.6	1.5	1.4	1.3	1.2	1.0			30.0
32.0										30.3m/1.7	1.4	1.2	1.2	1.0					32.0
34.0											32.9m/1.3	1.0							34.0
36.0												35.6m/1.0							36.0
Reeves		8	8	6	5	4	4	3	3	3	2	2	2	2	2	2			Reeves

Note:  
 Ratings according to EN13000.  
 Ratings shown in   are determined by the strength of the boom or other structural components.  
 Weight of hooks, hook blocks, slings and other lifting devices are a part of the total load.  
 Their total weight must be subtracted from the rated load to obtain the weight that can be lifted.



## Fixed Jib Lifting Capacities (Without Main Hook Block)

### Jib Offset Angle : 10°

Counterweight: 13.0 t

Unit: metric ton

Boom length (m)	30.5			33.5			36.6			39.6			42.7		Boom length (m)
Jib length (m)	6.1	12.2	18.3	6.1	12.2	18.3	6.1	12.2	18.3	6.1	12.2	18.3	6.1	12.2	Jib length (m)
9.0	7.0			7.0											9.0
10.0	7.0			7.0			7.0			7.0					10.0
12.0	7.0	7.0	4.5	7.0	7.0		7.0	7.0		7.0			6.9		12.0
14.0	6.7	6.7	4.5	6.5	6.4	4.5	6.2	6.2	4.5	5.9	5.9	4.5	5.7	5.7	14.0
16.0	5.5	5.7	4.5	5.4	5.4	4.5	5.2	5.2	4.5	4.9	5.0	4.5	4.7	4.7	16.0
18.0	4.6	4.7	4.5	4.5	4.6	4.5	4.4	4.4	4.3	4.1	4.2	4.1	3.9	4.0	18.0
20.0	3.9	4.0	4.0	3.8	3.9	3.9	3.7	3.8	3.7	3.5	3.6	3.5	3.3	3.4	20.0
22.0	3.3	3.4	3.5	3.2	3.3	3.4	3.1	3.3	3.2	2.9	3.0	3.0	2.8	2.9	22.0
24.0	2.8	3.0	3.0	2.7	2.9	2.9	2.6	2.8	2.8	2.5	2.6	2.6	2.3	2.4	24.0
26.0	2.4	2.6	2.6	2.3	2.5	2.5	2.2	2.4	2.4	2.1	2.2	2.2	2.0	2.1	26.0
28.0	2.1	2.2	2.3	1.9	2.1	2.2	1.8	2.0	2.1	1.7	1.9	1.9	1.6	1.7	28.0
30.0	1.8	1.9	2.0	1.6	1.8	1.9	1.5	1.7	1.8	1.4	1.6	1.6	1.3	1.5	30.0
32.0	1.5	1.7	1.7	1.4	1.6	1.6	1.3	1.5	1.5	1.2	1.3	1.4	1.1	1.2	32.0
34.0		1.4	1.5	1.2	1.3	1.4	1.1	1.2	1.3		1.1	1.1		1.0	34.0
36.0		1.2	1.3	1.0	1.1	1.2		1.0	1.1						36.0
38.0		1.1	1.1		1.0	1.0									38.0
40.0			1.0												40.0
Reeves	1	1	1	1	1	1	1	1	1	1	1	1	1	1	Reeves



## Fixed Jib Lifting Capacities (Without Main Hook Block)

### Jib Offset Angle : 30°

Counterweight: 13.0 t

Unit: metric ton

Boom length (m)	30.5			33.5			36.6			39.6			42.7		Boom length (m)
Jib length (m)	6.1	12.2	18.3	6.1	12.2	18.3	6.1	12.2	18.3	6.1	12.2	18.3	6.1	12.2	Jib length (m)
12.0	7.0			7.0			7.0			7.0					12.0
14.0	7.0			6.8			6.6			6.3			6.1		14.0
16.0	5.7	5.0		5.7	5.0		5.5	5.0		5.2	5.0		5.0		16.0
18.0	4.8	5.0	3.2	4.7	5.0	3.2	4.6	4.9		4.4	4.7		4.2	4.5	18.0
20.0	4.1	4.3	3.2	4.0	4.3	3.2	3.9	4.2	3.2	3.7	4.0	3.2	3.6	3.8	20.0
22.0	3.5	3.7	3.2	3.4	3.7	3.2	3.3	3.6	3.2	3.2	3.4	3.2	3.0	3.3	22.0
24.0	3.0	3.2	3.2	2.9	3.2	3.2	2.8	3.1	3.2	2.7	3.0	3.1	2.6	2.8	24.0
26.0	2.5	2.8	2.9	2.4	2.7	2.9	2.4	2.7	2.8	2.2	2.5	2.7	2.1	2.4	26.0
28.0	2.2	2.4	2.6	2.1	2.4	2.5	2.0	2.3	2.4	1.9	2.2	2.3	1.8	2.1	28.0
30.0	1.9	2.1	2.3	1.8	2.0	2.2	1.7	2.0	2.1	1.6	1.8	2.0	1.5	1.8	30.0
32.0		1.8	2.0	1.5	1.8	1.9	1.4	1.7	1.8	1.3	1.6	1.7	1.2	1.5	32.0
34.0		1.6	1.8		1.5	1.7	1.2	1.4	1.6	1.0	1.3	1.5	1.0	1.2	34.0
36.0			1.5		1.3	1.4		1.2	1.4		1.1	1.2		1.0	36.0
38.0			1.3			1.2		1.0	1.2			1.0			38.0
40.0			1.1			1.1			1.0						40.0
Reeves	1	1	1	1	1	1	1	1	1	1	1	1	1	1	Reeves

Note:

Ratings according to EN13000.

Ratings shown in   are determined by the strength of the boom or other structural components.

Weight of hooks, hook blocks, slings and other lifting devices are a part of the total load.

Their total weight must be subtracted from the rated load to obtain the weight that can be lifted.

# TRANSPORTATION PLAN

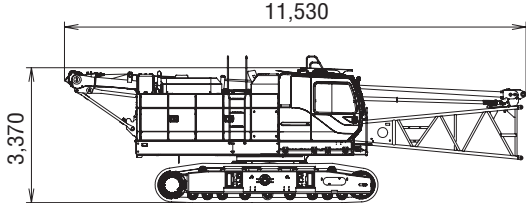
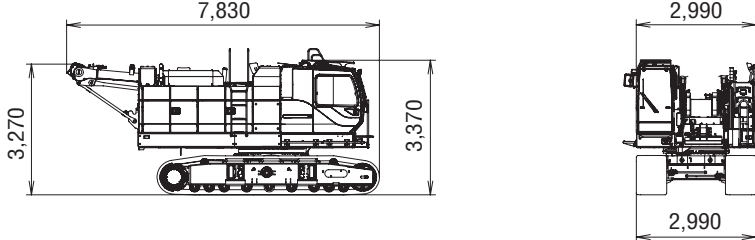
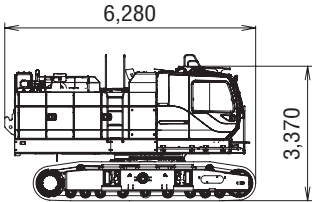
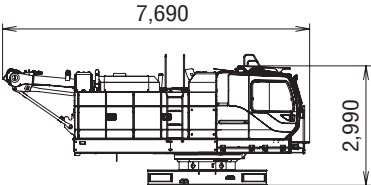
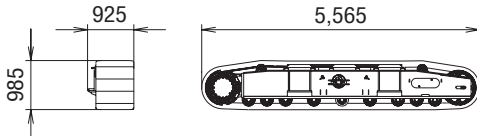
Name	Dimension	Weight (kg)
<b>Base Machine</b> <ul style="list-style-type: none"> <li>• Boom base</li> <li>• Gantry</li> <li>• Crawler</li> <li>• Wire rope (Front / boom hoist)</li> </ul>		31,430
<b>Base Machine</b> <ul style="list-style-type: none"> <li>• Gantry</li> <li>• Crawler</li> <li>• Wire rope (Front / rear / boom hoist)</li> </ul>		30,020
<b>Base Machine</b> <ul style="list-style-type: none"> <li>• Boom base</li> <li>• Wire rope (Front / boom)</li> </ul>		28,770
<b>Base Machine</b> <ul style="list-style-type: none"> <li>• Gantry</li> <li>• Wire rope (Front / boom / boom drum)</li> <li>• Without crawler</li> </ul>		19,200
Crawler		5,410









# PARTS AND ATTACHMENTS

## Base Machine

Boom base, Gantry, Crawler, Wire rope (Front/boom hoist)  
Weight: 31,430 kg Width: 2,990mm

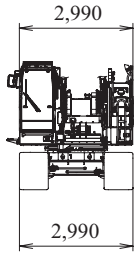
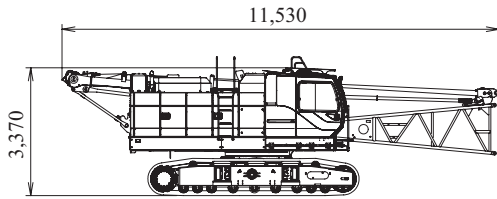

## Crawler

Weight: 5,410 kg

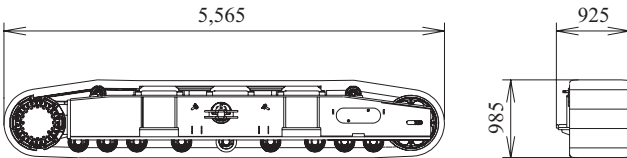

## Jib tip

Weight: 145 kg

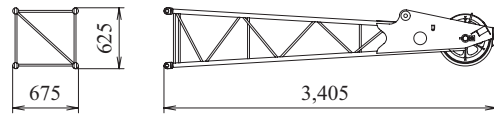

## Boom base

Weight: 125 kg

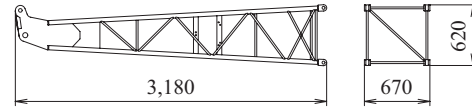

## Jib strut

Weight: 190 kg

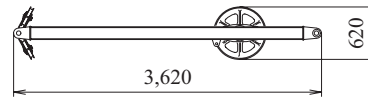

## 6.1 m (20 ft) Jib insert

Weight: 140 kg

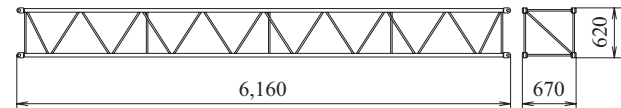

## Counterweight No.1

Weight: 4,920 kg

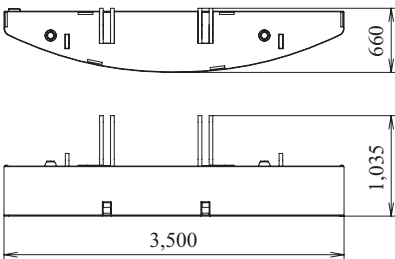

## Counterweight No.2

Weight: 6,080 kg

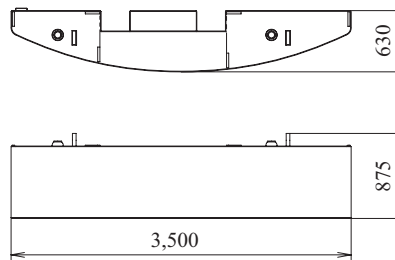

## Counterweight No.2 (L)

Weight: 800 kg

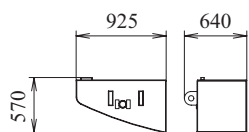

## Counterweight No.2 (R)

Weight: 1,230 kg

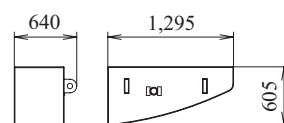

**Boom tip**  
Weight: 1,010 kg

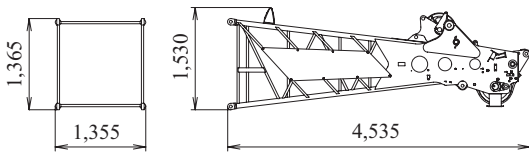

**Boom base**  
Weight: 980 kg

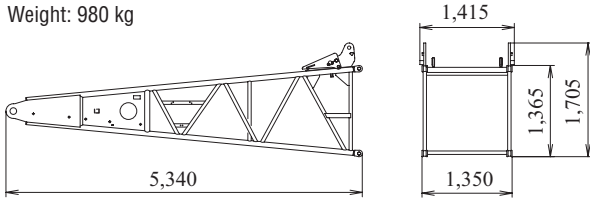

**3.0 m (10 ft) Boom insert**  
Weight: 255 kg

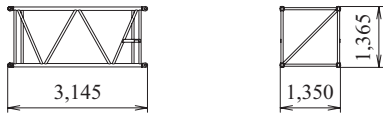

**6.1 m (20 ft) Boom insert**  
Weight: 430 kg

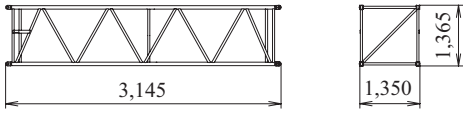

**6.1 m (20 ft) Boom insert with lug**  
Weight: 445 kg

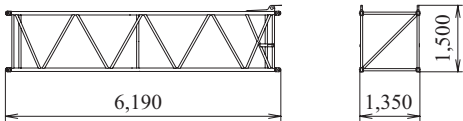

**9.1 m (30 ft) Boom insert**  
Weight: 615 kg

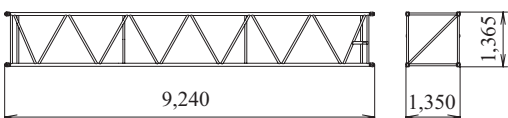

**9.1 m (30 ft) Boom insert with lug**  
Weight: 630 kg

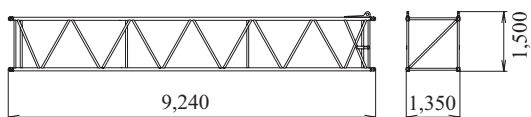

**Auxiliary sheave**  
Weight: 140 kg

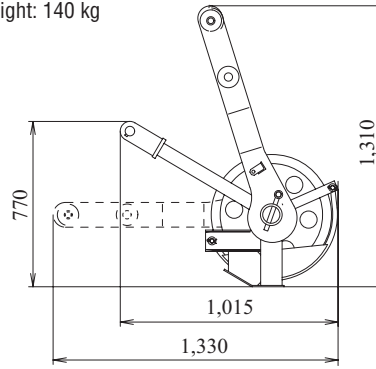

**Upper spreader**  
Weight: 280 kg

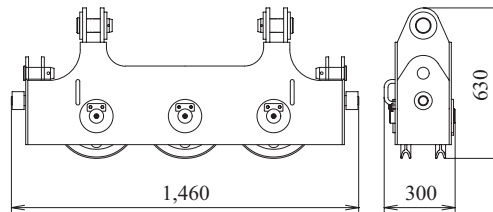

**Lower spreader**  
Weight: 200 kg

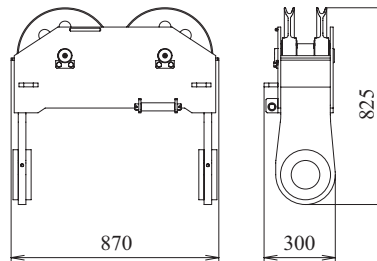

**19 t hook**  
Weight: 400 kg

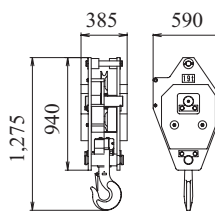

**32 t hook**  
Weight: 500 kg

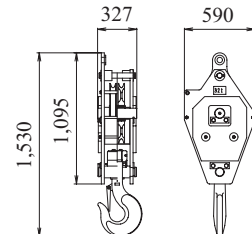

**60 t hook**  
Weight: 700 kg

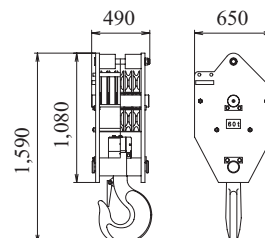

Note: This catalog may contain photographs of machines with specifications, attachments and optional equipment not certified for operation in your country. Please consult KOBELCO for those items you may require. Due to our policy of continual product improvements all designs and specifications are subject to change without advance notice.

Copyright by KOBELCO CRANES CO., LTD. No part of this catalog may be reproduced in any manner without notice.



## **KOBELCO CRANES CO., LTD.**

17-1, Higashigotanda 2-chome, Shinagawa-ku, Tokyo 141-8626 JAPAN

Tel: +81-3-5789-2130 Fax: +81-3-5789-3372

**URL: <http://www.kobelco-cranes.com/>**

Inquiries To: