

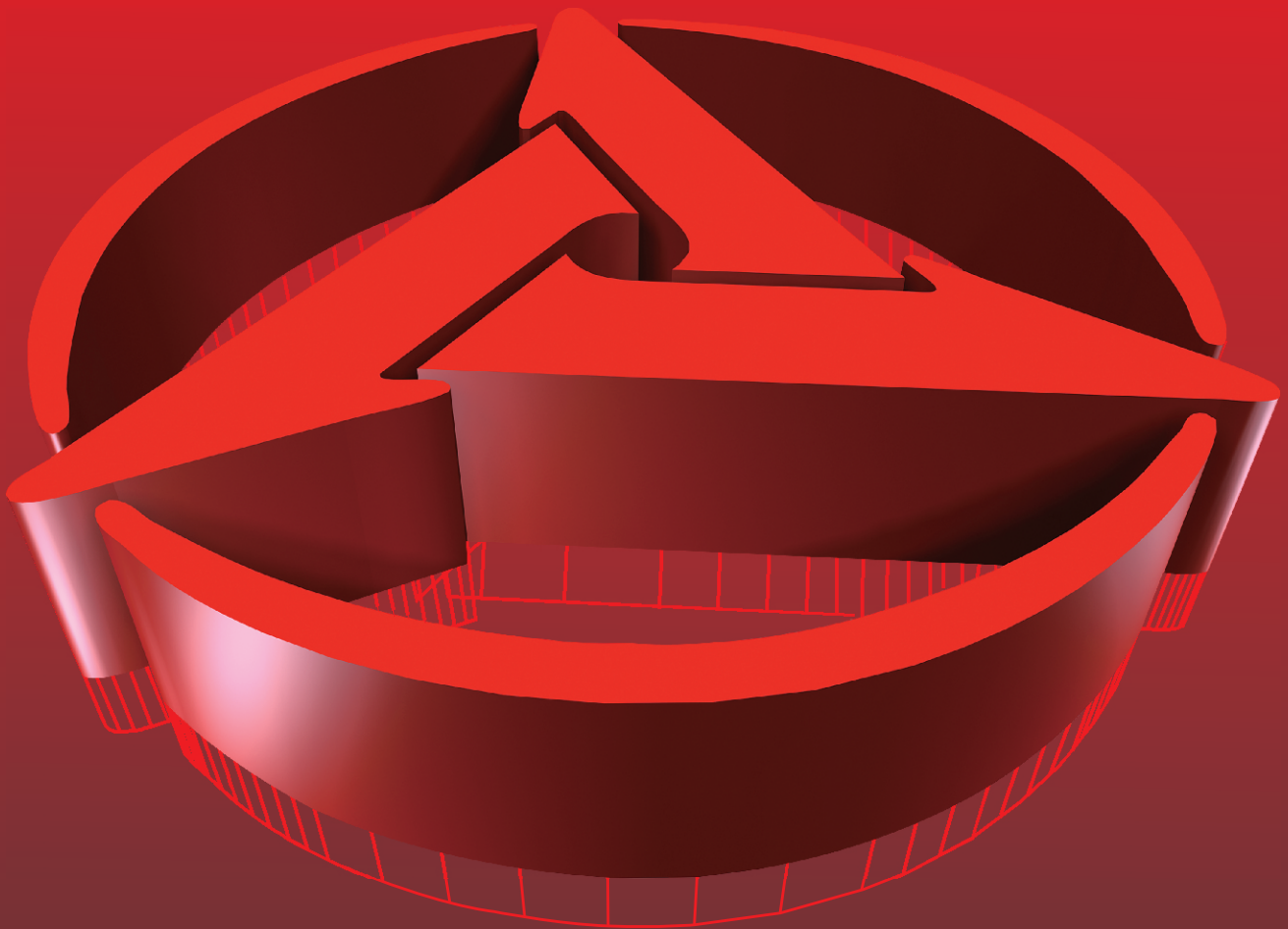

**SANY**

# **STC75 TRUCK CRANE**

75t Lifting Capacity



45<sub>m</sub>

Max. rated lifting capacity 75t, min. working range 3.0m.

Five-section and partially synchronized telescoping lifting booms, max. lifting height of main boom 45m.

275<sub>KW</sub>

Max. rated output of engine 275kW, Euro III emission standard.











Max travel speed 80km/h, max. grade ability 40%(in theory).

40%

Sany Moment Limiter provides effective and safety protection for customers.

Main pump, main valve, winch motor, balance valve these key hydraulic parts all adopted imported configurations, fine operation and high stability.

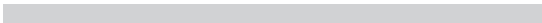
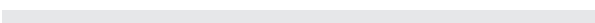

	<b>Technical specifications</b>
	Dimensions
	Specifications
	<b>Technical description</b>
	Carrier
	Superstructure
	<b>Main boom</b>
	Working radius
	Lifting capacity
	<b>Jib</b>
	Working radius
	Lifting capacity



## Load

Front axle	Rear axle	Overall weight
<b>20000</b>	<b>26000</b>	<b>46000</b>
kg	kg	kg

## Working speed

Working speed	130m/min
Max.pull	83.7kN
Wire rope diameter × length(main winch)	20mm × 235m
Max. speed of main and secondary winch	130m/min
Wire rope diameter*length(secondary winch)	20mm × 135m
Max. slewing speed	2 r/min
Boom elevation	-2°~80°
Slewing diameter	4m

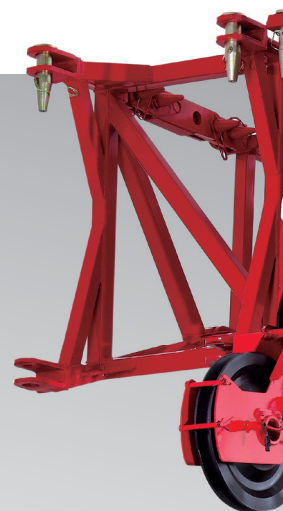





Travel speed

**80**  
km/h

Gradeability

**40%**

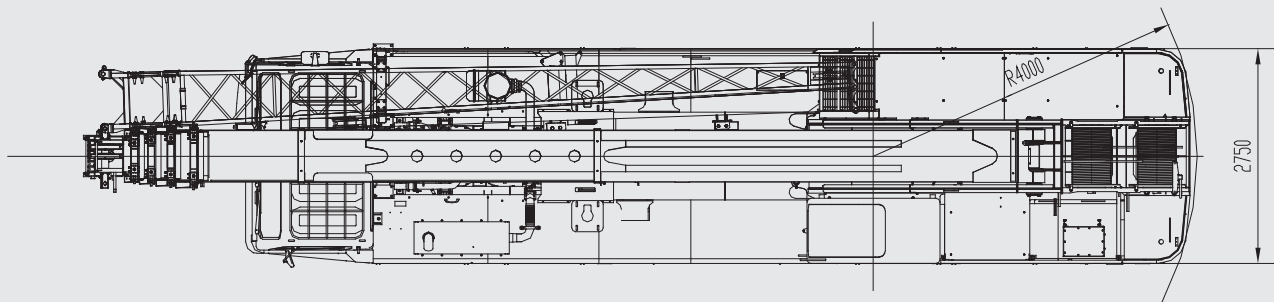
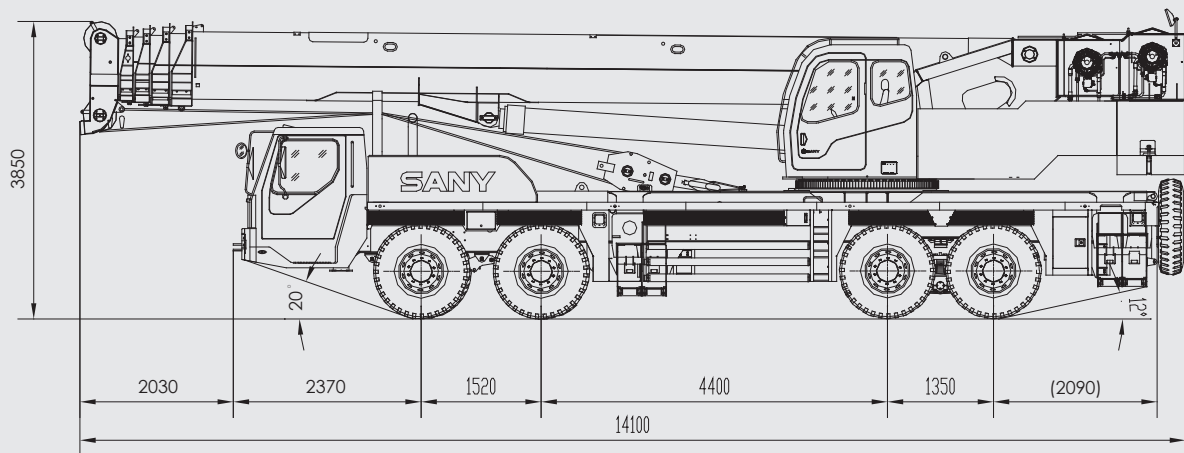

## Technical Parameters

Type	Item	Unit	Parameter	
Dimension	Overall length	mm	14100	
	Overall Width	mm	2750	
	Overall Height	mm	3700	
	Axle base between	The 1st and 2nd axle	mm	1520
		The 2nd and 3rd axle	mm	4400
		The 3rd and 4th axle	mm	1350
	Wheel track of	The 1st and 2nd axle	mm	2300
The 3rd and 4th axle		mm	2055	
Weight	Total Mass	kg	46000	
	Loading Weight of	The 1st and 2nd axle	kg	20000
		The 3rd and 4th axle	kg	26000
Engine	Rated Power	DCEC ISLe375.30	Kw/rpm	275/2100
	Maximum torque	DCEC ISLe375.30	N.m/rpm	1550 /1200~1400
Traveling Parameters	Traveling speed	Maximum speed	Km/h	80
	Turning radius	Min. turning radius	m	11.5
		Minimum turning radius of jib nose	m	15.5
	Minimum ground clearance		mm	290
	Front approach angle		°	≥20
	Back acceptance angle		°	≥12
	Braking distance (when the speed is 30km/h)		m	≤10
	Gradeability		%	40
	Oil consumption per 100 KM		l	≤50
Main Performance Parameters	Maximum rated lifting capacity		t	75
	Minimum rated radius		m	3
	Turntable tail slewing diameter		m	4
	Maximum lifting torque of	Main boom	kN.m	2400
		Main boom fully extended	kN.m	941
		Main boom fully extended and jib	kN.m	318
	Outrigger Span ( Vertical × Horizontal )		m	6.1 × 7.6
	Maximum hoist height of	Main boom	m	12
		Main boom fully extended	m	45
		Main boom fully extended and jib	m	61
	Maximum boom length of	Main boom	m	11.8
Main boom fully extended		m	45	
Main boom fully extended and jib		m	61	
Offset angle of jib		°	0、15、30	
Efficiency Parameters	Max. single line hoist speed of Main winch ( No load )		m/min	130
	Max. single line hoist speed of Aux winch ( No load )		m/min	130
	Time for boom fully extended/retracted		s	120/130
	Time for boom fully lifted/dropped		s	80/90
	Turning speed		r/min	0~2
	Time for the horizontal outrigger fully extension/retraction		s	40/30
	Time for the vertical outrigger fully extension/retraction		s	35/40

## Technical description/Carrier

### 1 Drive/Steering



### 2 Frame

Integrated welding structure and fabricated from high-strength steel.

### 4 Engine

Dongfeng Cummins ISLe37530, rated power 275kW, rated torque 1550/1200~1400 N·m/(r/min).

### 3 Outriggers

H-form arrangement, and fully hydraulic control with vertical and horizontal extension, independent outrigger movement. span of outriggers: 7.62m\*6.1m.

### 5 Transmission

Imported EATON gearbox, pull-type clutch with super-speed gear.

## 6 Wheel and tyre

12 tyres, 12.00R20  
20PRs.

## 9 Axle



## 7 Steering

single circuit hydraulic-assist steering system with mechanical slewing-limit.

## 10 Suspension

Steel spring imbalanced suspension on axle 1 and 2, steel spring two-axle balanced suspension on axle 3 and 4.

## 8 Electric equipment 24V, CAN Bus.



## 11 Driver's cab

ergonomic design, vertically adjustable steering wheel, air-conditioner.

## 12 Brake

Adopted air brake. Dual-circuit driving brake controlled by foot pedal; parking brake and emergency brake operated by hand brake handle, air exhaust brake.

## 13 Hydraulic system

Electrical-controlled outrigger+ active counterweight aux. installation system.



## Superstructure

### 1 Operator's cab

Fabricated from corrosion-resistant steel, equipped full-covered flexible decorations, front window door could open, adjustable seat provide comfort for the driver.

### 2 Boom

Five sections boom, hexagonal cross section; telescopic mechanism assisted by two cylinders and sheaves.

### 3 Counterweight

4.5t, mounted on the turntable through connecting bolts. 2.0t active counterweight for option.

### 4 Hydraulic system

Load feedback system (Kawasaki main pump+ US Husco main valve), regulating main pump through load feedback pressure, to make pressure and flow adjust load, pivot pressure through pivot handle to realize infinite speed.

### 5 Safety devices

Colorful LCD, integrated load moment indicator, hook load, rated load, boom length, angle, lifting height. Load charts and working parameter set-up, equipped with safety-limit function.

### 6 Main winch

Variable displacement piston motor, hydraulic braking system, equipped Rexroth balance valve, max speed(single rope) 130m/min, rope length 235m.





## 7 Aux. winch

Variable displacement piston motor, hydraulic braking system, mounted balanced valve. Max speed(single rope) 130m/min, rope length 130m.

## 8 Elevation

Deadweight-dependent elevation control, stable operation and fine slow-motion.

## 9 Slew

Germany Rexroth constant displacement piston motor and reducer, slewing system composed of Husco slewing switch valve, max slewing speed 2r/min, constant closed brake.

### STC75 truck crane lifting height

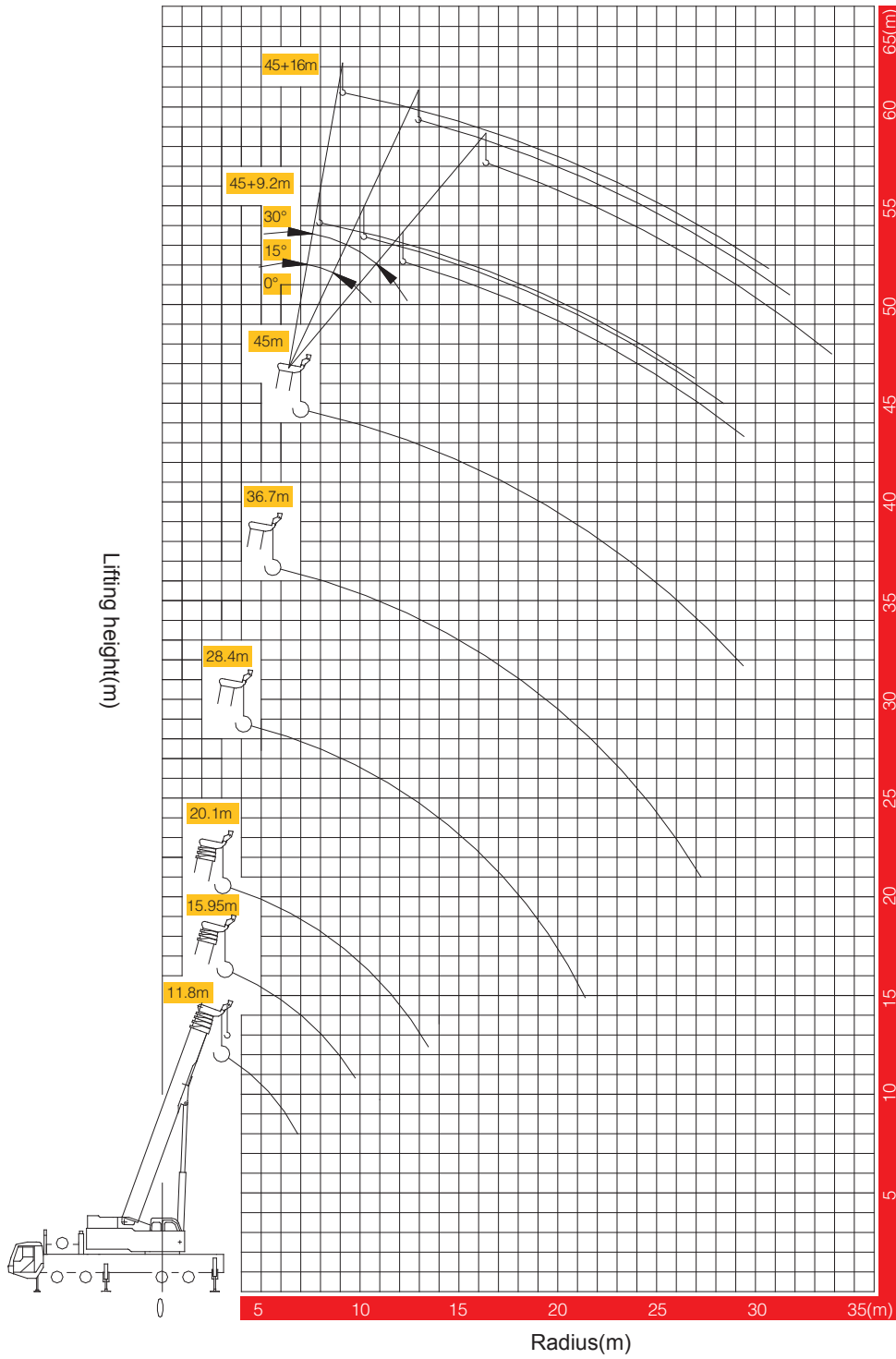

## Load chart for main boom

( Unit: kg )

Full-extend outriggers, over side and rear (4.5t counterweight)															
Work radius (m)	11.8m		15.95m		20.1m		28.4m		36.7m		45m				
	Lifting weight (kg)	Boom elevation (°)	Lifting weight (kg)	Boom elevation (°)	Lifting weight (kg)	Boom elevation (°)	Lifting weight (kg)	Boom elevation (°)	Lifting weight (kg)	Boom elevation (°)	Lifting weight (kg)	Boom elevation (°)			
3	75000	69.8	54000	75.3	43000	30000	78.4								
3.5	70000	67.1	54000	73.4	43000	29000	76.9								
4	62000	64.3	51000	71.5	43000	27000	75.5	30000	16000	79.8					
4.5	56000	61.5	48000	69.5	40900	25000	74.0	30000	16000	78.8					
5	51000	58.6	45000	67.6	38000	23000	72.4	30000	16000	77.7					
5.5	47000	55.5	42000	65.6	35400	21000	70.9	29000	15500	76.7					
6	41500	52.4	39000	63.5	33100	19500	69.4	27500	15000	75.6					
6.5	36000	49.0	35000	61.4	31100	16500	67.8	26000	15000	74.6	16000	9500	78.1		
7	32000	45.4	30500	59.3	28500	15000	66.2	24500	14000	73.5	16000	9500	77.3		
8	25000	37.4	24500	54.8	24000	13000	63.0	22000	13000	71.4	15000	9000	75.7	9500	78.4
9	19000	27.0	20000	50.1	20000	10000	59.7	19500	12000	69.2	15000	9000	74.1	9500	77.1
10			16500	45.0	17000	9000	56.2	16000	11000	67.0	14000	9000	72.5	9000	75.8
11			13500	39.3	14000	8000	52.6	13600	9500	64.8	13000	8500	70.8	9000	74.5
12			11500	32.6	12000	7600	48.8	12000	8000	62.5	12000	8200	69.1	9000	73.1
13					9000	7200	44.7	10500	7500	60.1	11000	8000	67.4	9000	71.8
14					8500	6800	40.3	9000	7000	57.7	10000	7000	65.7	8500	70.4
15					6500	6500	35.3	7500	6500	55.3	9200	6500	64.0	8250	69.1
16					6000	6000	29.6	6800	6000	52.7	7800	5100	62.2	8000	67.7
18								5000	5500	47.3	6000	4000	58.5	6500	64.9
20								4000	5000	41.3	4800	3800	54.7	5100	62.0
22								2900	4000	34.5	3800	3600	50.7	4100	59.0
24								2200	3200	26.0	2900	3300	46.5	3300	56.0
26											2200	3000	41.9	2600	52.8
28											1700	2500	36.8	2000	49.5
30											1300	2000	31.0	1500	46.0
32														1200	42.2
34															
Number of lines	12		9		9		6		5		3				
Boom elevation	69.8° ~ 27.0°		75.3° ~ 32.6°		78.4° ~ 29.6°		79.8° ~ 26.0°		78.1° ~ 31.0°		78.4° ~ 42.2°				
Telescoping condition	2nd boom	0%		50%		100%	0%		100%	0%		100%			
	3rd boom	0%		0%		0%	33%		33%	66%		66%	100%	100%	
	4th boom	0%		0%		0%	33%		33%	66%		66%	100%	100%	
	5th boom	0%		0%		0%	33%		33%	66%		66%	100%	100%	

## Load chart for main boom

( Unit: kg )

Full-extend outriggers, over side and rear(4.5t+2t counterweight)															
Work radius (m)	11.8m		15.95m		20.1m			28.4m			36.7m			45m	
	Lifting weight (kg)	Boom elevation (°)	Lifting weight (kg)	Boom elevation (°)	Lifting weight (kg)	Boom elevation (°)	Lifting weight (kg)	Boom elevation (°)	Lifting weight (kg)	Boom elevation (°)	Lifting weight (kg)	Boom elevation (°)	Lifting weight (kg)	Boom elevation (°)	
3	75000	69.8	54000	75.3	43000	30000	78.4								
3.5	70000	67.1	54000	73.4	43000	29000	76.9								
4	62000	64.3	51000	71.5	43000	27000	75.5	30000	16000	79.8					
4.5	56000	61.5	48000	69.5	40900	25000	74.0	30000	16000	78.8					
5	51000	58.6	45000	67.6	38000	23000	72.4	30000	16000	77.7					
5.5	47500	55.5	42000	65.6	35400	21000	70.9	29000	15500	76.7					
6	43000	52.4	39000	63.5	33100	20000	69.4	27500	15000	75.6					
6.5	39000	49.0	36000	61.4	31100	18200	67.8	26000	15000	74.6	16000	9500	78.1		
7	35000	45.4	32500	59.3	28500	16200	66.2	25000	14000	73.5	16000	9500	77.3		
8	26500	37.4	26200	54.8	26100	13000	63.0	22000	13000	71.4	15000	9000	75.7	9500 78.4	
9	20500	27.0	21500	50.1	21000	10000	59.7	20000	12500	69.2	15000	9000	74.1	9500 77.1	
10			17500	45.0	17500	9000	56.2	17000	11500	67.0	14000	9000	72.5	9000 75.8	
11			14300	39.3	14500	8000	52.6	14500	9600	64.8	13000	8600	70.8	9000 74.5	
12			12000	32.6	12300	7600	48.8	12500	8500	62.5	12500	8250	69.1	9000 73.1	
13					10100	7200	44.7	11500	7500	60.1	12000	8000	67.4	9000 71.8	
14					9000	6800	40.3	9500	7000	57.7	10500	7000	65.7	8500 70.4	
15					7400	6500	35.3	8700	6500	55.3	9400	6500	64.0	8250 69.1	
16					6300	6000	29.6	7200	6000	52.7	8400	5500	62.2	8000 67.7	
18								5200	5500	47.3	6500	5200	58.5	6800 64.9	
20								4100	5000	41.3	5200	5000	54.7	5500 62.0	
22								3100	4200	34.5	4100	4500	50.7	4500 59.0	
24								2400	3800	26.0	3200	4000	46.5	3500 56.0	
26											2500	3500	41.9	2800 52.8	
28											2000	3000	36.8	2200 49.5	
30											1500	2500	31.0	1700 46.0	
32														1400 42.2	
34															
Number of lines	12		9		9			6			5			3	
Boom elevation	69.8° ~ 27.0°		75.3° ~ 32.6°		78.4° ~ 29.6°			79.8° ~ 26.0°			78.1° ~ 31.0°			78.4° ~ 42.2°	
Telescoping condition	2nd boom	0%		50%		100%	0%		100%	0%		100%	0%		100%
	3rd boom	0%		0%		0%	33%		33%	66%		66%	100%		100%
	4th boom	0%		0%		0%	33%		33%	66%		66%	100%		100%
	5th boom	0%		0%		0%	33%		33%	66%		66%	100%		100%



## Load chart for jib

( Unit: kg )

Working angle	Fully extended outriggers, over rear and side					
	45+9.2m jib			45+16m jib		
	0°	15°	30°	0°	15°	30°
80°	3500	2400	2000	2800	1500	1100
78°	3500	2400	2000	2400	1450	1000
77°	3200	2300	1900	2400	1400	1000
75°	3000	2200	1800	2300	1300	950
73°	2700	2000	1700	2000	1200	850
71°	2500	1800	1600	1800	1100	850
68°	2200	1700	1400	1500	1000	800
66°	2000	1500	1300	1300	950	760
63°	1800	1400	1100	1100	850	720
61°	1500	1200	950	950	750	650
58°	1100	950	750	650	600	550
56°	700	650	550	500		
Min. elevation angle	55°					

### Notes for STC75 technical parameter:

1. All the above value in the table is rated loading capacity on the condition that ground is flat and hard enough, the value above heavy line is mainly affected by intensity, the value below heavy line is affected by the stability.
2. The radius value is in the actual working condition, jib working radius value is in actual working condition, when main boom is fully extended ( 45m ) and jib is unfolded.
3. The above value in the table is suitable for 360degree working if the 5th outrigger is extended. But keep off lifting things over the driving cab in case of dropping.
4. The above value in the table includes hook's and lifting device's weight. Main hook 800KG、320KG, auxiliary hook140KG. The main hook weight should reduce 2000KG if jib is unfolded.
5. When the actual boom length or working radius is between 2 values, adopt the larger value to calculate the lifting load.
6. Prohibit luffing exceeding min. elevation.
7. If the auxiliary hook is working, main hook is still attached to the boom tip, the rated load of auxiliary hook should reduce main hook's weight(800KG or320KG).



**三一汽车起重机械有限公司**  
**SANY Mobile Cranes CO.,LTD.**

Address: Jinzhou development, Changsha, Hunan, China

Tel: (86)731-87873131

Fax: (86)731-84031999-196

Service hotline: 4008878318

Consulting line: 4008879318

E-mail: qzjyx@sany.com.cn

Post code: 410600

Web: [www.sanygroup.com](http://www.sanygroup.com)

Sany reserves the right to amend these specifications at any time without notice.

Further technology details according to actual product!