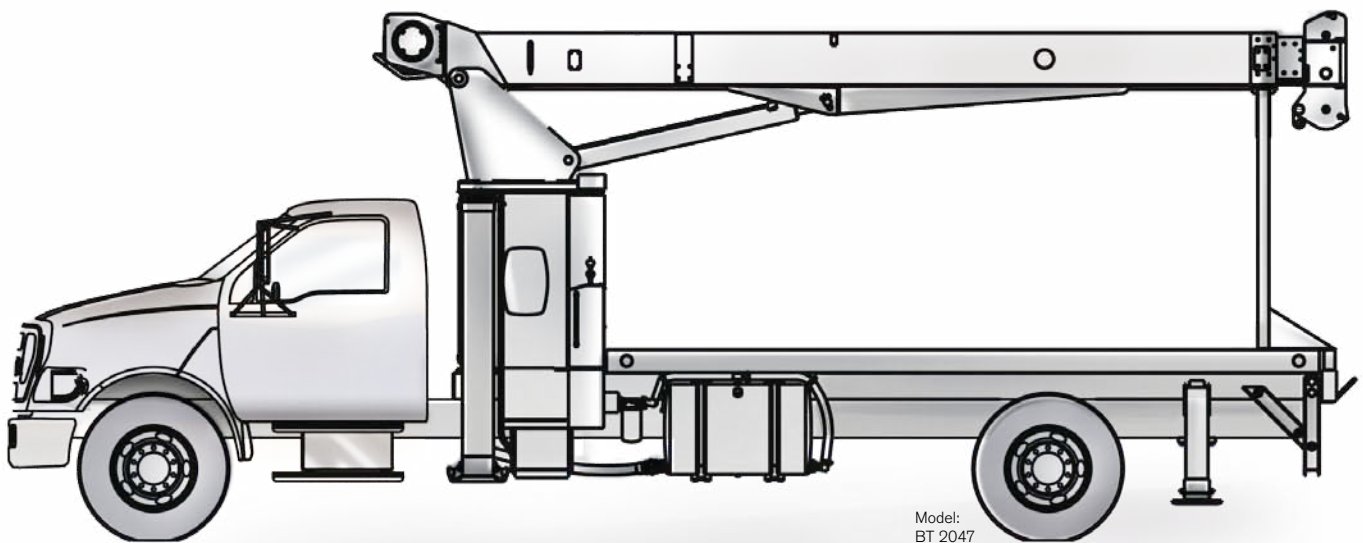

BT 2047

BT 2057

**Features: BT 2047**

- ▶ 10 US t @ 5 ft capacity at rated distance from center of rotation
- ▶ 47 ft maximum boom length
- ▶ 56 ft 5 in maximum tip height
- ▶ 18–30 ft optional jib
- ▶ 85 ft 9 in maximum sheave height with 30 ft jib

Features: BT 2057

- ▶ 10 US t @ 5 ft capacity at rated distance from center of rotation
- ▶ 57 ft maximum boom length
- ▶ 66 ft 5 in maximum tip height
- ▶ 22–36 ft optional jib
- ▶ 101 ft 9 in maximum sheave height with 36 ft jib

Key

..... 3

BT 2047

Dimensions

Crane Dimensions 4, 5
Area of Operation 5
Mounting Specifications 5
Range Diagram 6

Load charts

Boom Load Chart 7
Jib, Retracted 7
Jib, Extended 7

BT 2057

Dimensions

Crane Dimensions 8, 9
Area of Operation 9
Mounting Specifications 9
Range Diagram 10

Load charts

Boom Load Chart 11
Jib, Retracted 11
Jib, Extended 11

Technical description

Boom, Jib and Rotation 12
Operator Controls and Operator Aid 12, 13
Understructure 13
Optional Features 13

	Main boom		Main Hoist
	Boom length		Hoist line speed
	Tip height		Part line
	Telescoping mode		Operator aid
	Boom angle		Controls
	Working radius		Hydraulics
	Boom with jib		Working temperature
	Boom head		Outriggers
	Hook block		Working speeds
	Hook to head sheave pin		Rope – Standard / Optional
	Rotation / Allowable rotation range		Rope diameter
	Boom angle		Rope length
	Boom over the rear		Line pull

DIMENSIONS

BT 2047

Crane Dimensions

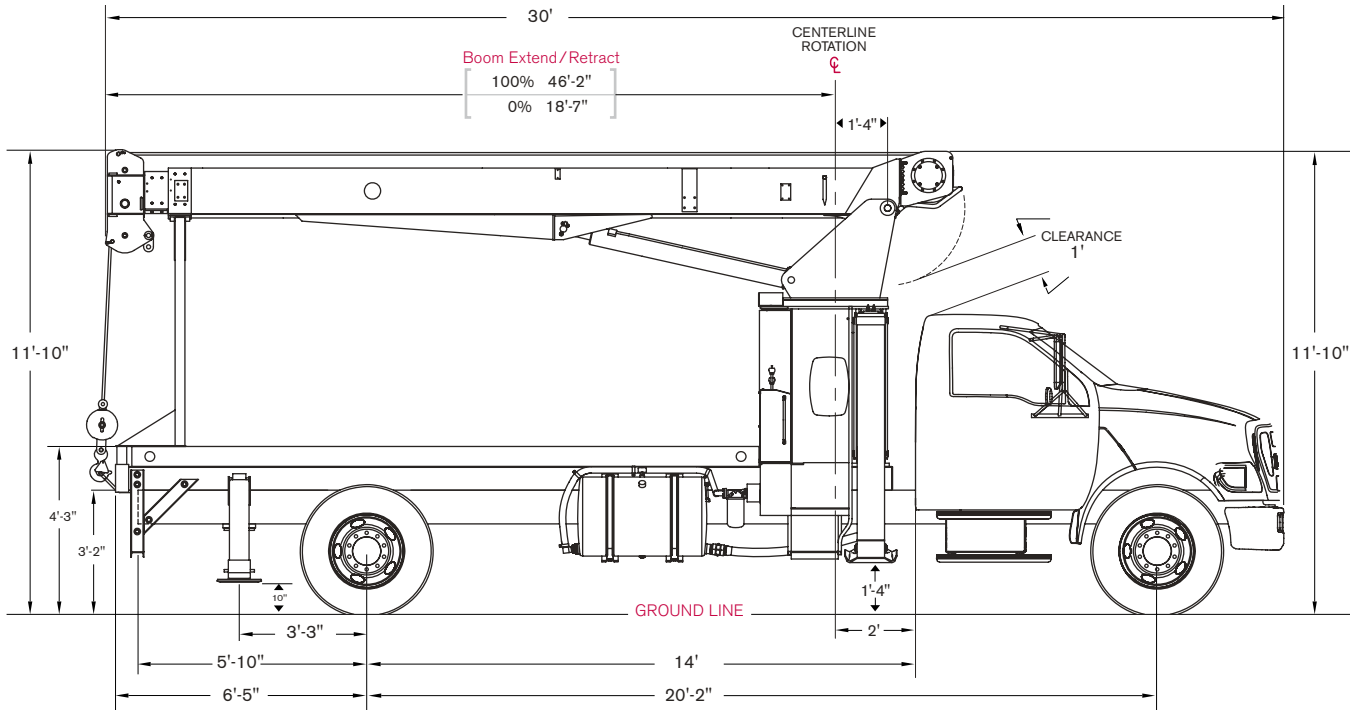

Area of Operation

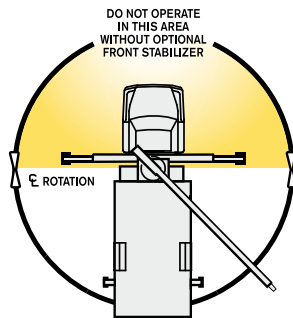

Mounting Specifications

Chassis recommendation

Gross vehicle weight rating	33,000 lb
Front axle weight rating	12,000 lb
Rear axle weight rating	21,000 lb
Crane weight	10,700 lb
Wheelbase	230 +/- 4 in
Cab to axle	156 +/- 4 in
Afterframe	80 +/- 4 in
RBM per framerail	1,200,000 lb/in

RANGE DIAGRAM

BT 2047

Outriggers Fully Extended (100%)

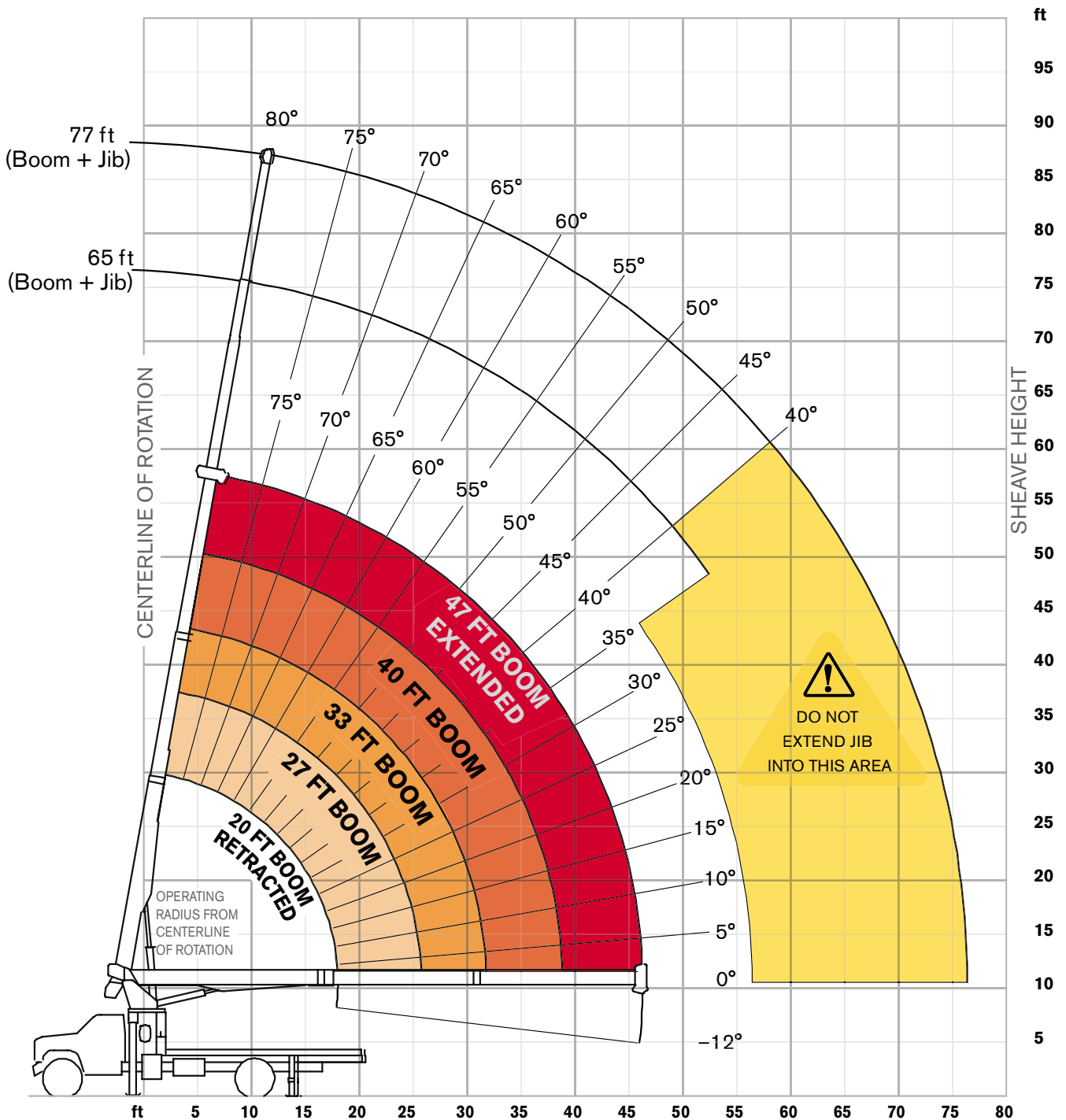
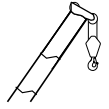

BOOM LOAD CHARTS

BT 2047

Outriggers Fully Extended (100%)

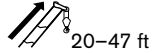

Standard ASME B30.5

ft	Boom Length					ft
	20 lb	27 lb	33 lb	40 lb	47 lb	
5	20,000	12,520				5
8	12,830	12,230	11,850	11,170		8
10	10,830	10,270	9,900	9,370	8,220	10
12	9,350	8,860	8,520	8,130	7,430	12
14	8,150	7,800	7,480	7,370	6,730	14
16	7,240	7,100	6,810	6,540	6,090	16
18	5,850	6,360	6,120	5,870	5,450	18
20		5,660	5,550	5,320	4,930	20
25		3,900	4,300	4,260	4,060	25
28			3,700	3,690	3,510	28
31			2,890	3,210	3,140	31
35				2,690	2,670	35
38				2,110	2,370	38
40					2,250	40
45					1,800	45
46					1,465	46

With Jib, Retracted and Extended

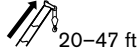

Standard ASME B30.5

ft	Jib Capacities for All Boom Lengths										ft
	35° lb	40° lb	45° lb	50° lb	55° lb	60° lb	65° lb	70° lb	75° lb	78° lb	
18	800	900	1,040	1,200	1,430	1,760	2,180	2,800	3,700	4,400	18
30	-	500	550	600	700	810	1,000	1,260	1,660	2,060	30

Notes to lifting capacity

Lifting capacities do not exceed 85% of tipping load. Weight of hook blocks and slings is part of the load, and is to be deducted from the capacity ratings. Consult operation manual for further details.

Note: Data published herein is intended as a guide only and shall not be construed to warrant applicability for lifting purposes. Crane operation is subject to the computer charts and operation manual both supplied with the crane.

DIMENSIONS

BT 2057

Crane Dimensions

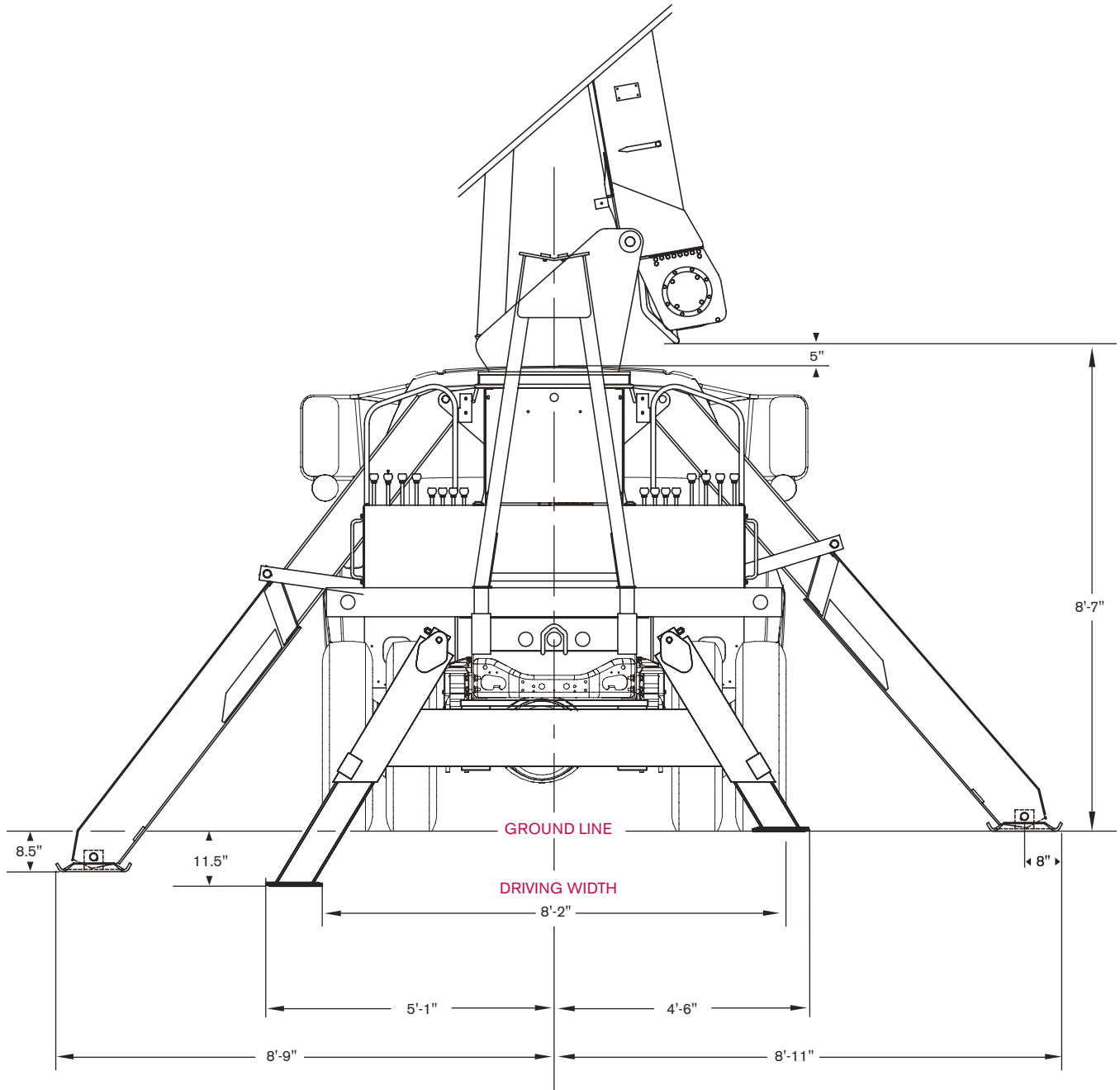

DIMENSIONS

BT 2057

Crane Dimensions

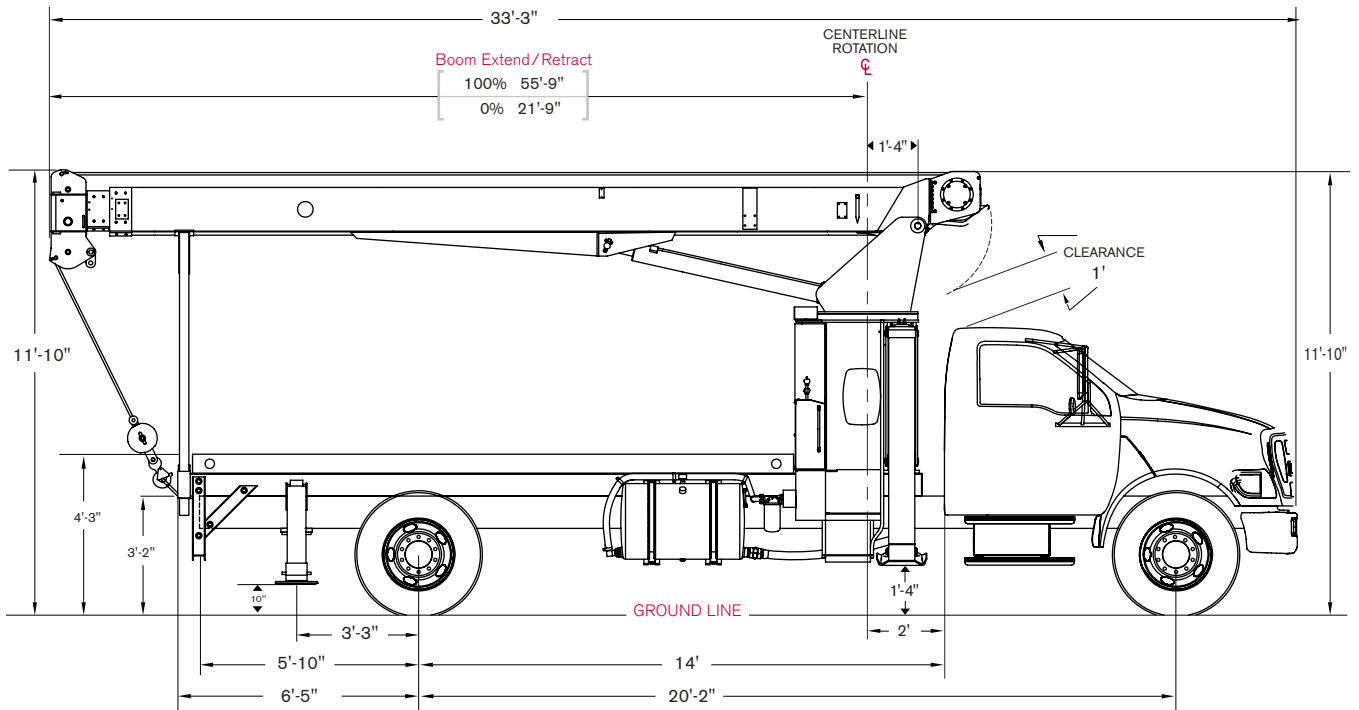

Area of Operation

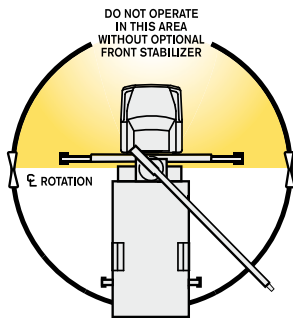

Mounting Specifications

Chassis recommendation

Gross vehicle weight rating	33,000 lb
Front axle weight rating	12,000 lb
Rear axle weight rating	21,000 lb
Crane weight	10,850 lb
Wheelbase	230 +/- 4 in
Cab to axle	156 +/- 4 in
Afterframe	80 +/- 4 in
RBM per framerail	1,200,000 lb/in

RANGE DIAGRAM

BT 2057

Outriggers Fully Extended (100%)

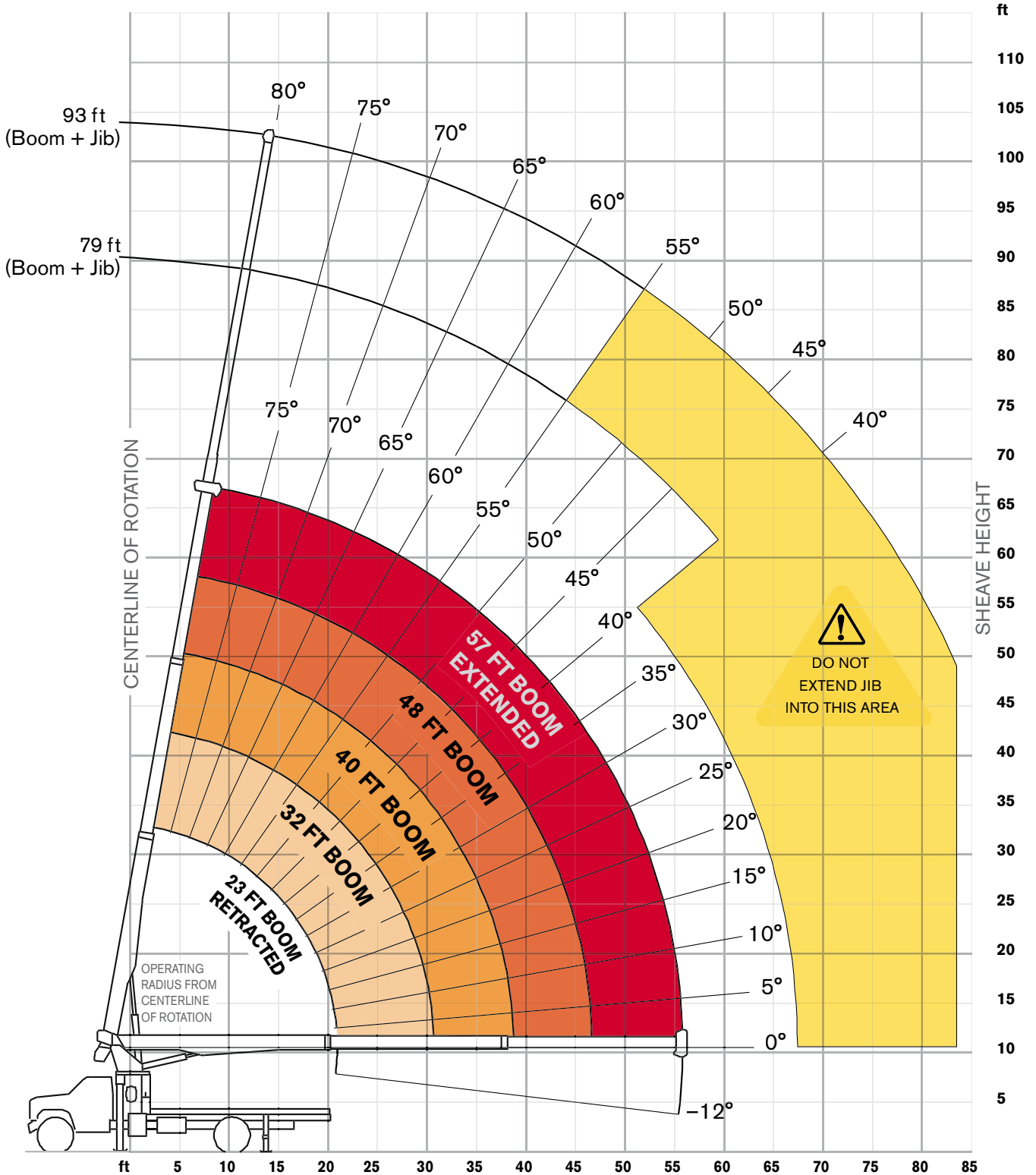
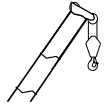



BOOM LOAD CHARTS

BT 2057

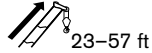
Outriggers Fully Extended (100%)





Standard ASME B30.5

	Boom Length					
	23	32	40	48	57	
ft	lb	lb	lb	lb	lb	ft
5	20,000					5
8	12,700	12,000	11,700			8
10	10,500	9,900	9,625	9,500		10
12	9,000	8,500	8,200	8,000	7,900	12
14	8,000	7,525	7,225	6,925	6,825	14
16	7,125	6,625	6,425	6,125	5,925	16
20	5,325	5,425	5,225	4,925	4,725	20
21	4,725	5,125	4,925	4,625	4,525	21
25		4,225	4,125	3,925	3,825	25
30		2,825	3,225	3,225	3,125	30
35			2,625	2,725	2,625	35
38			2,025	2,325	2,325	38
40				2,225	2,225	40
46				1,425	1,725	46
50					1,525	50
55					925	55

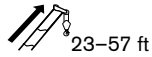
Boom at 0°





Standard ASME B30.5

	Boom Length					
	23	32	40	48	57	
°	lb	lb	lb	lb	lb	°
0	3,500	2,100	1,700	1,000	750	0

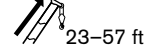
With Jib, Retracted and Extended



Standard ASME B30.5

	Jib Capacities for All Boom Lengths									
	40°	45°	50°	55°	60°	65°	70°	75°	80°	
ft	lb	lb	lb	lb	lb	lb	lb	lb	lb	ft
22	500	600	750	1,000	1,200	1,500	2,000	2,600	3,150	22
36	-	-	-	550	650	850	1,100	1,480	1,900	36

Notes to lifting capacity







Lifting capacities do not exceed 85% of tipping load. Weight of hook blocks and slings is part of the load, and is to be deducted from the capacity ratings. Consult operation manual for further details.

Note: Data published herein is intended as a guide only and shall not be construed to warrant applicability for lifting purposes. Crane operation is subject to the computer charts and operation manual both supplied with the crane.

TECHNICAL DESCRIPTION

BT 2047 / BT 2057

Boom, Jib and Rotation

	Three-section full power fully synchronized telescopic keel boom	
	Boom length	BT 2047 47 ft BT 2057 57 ft
	Boom elevation angle range (min/max)	-8° / 82°
	Boom up/down time	16/10 seconds
	Boom extension/retraction time	BT 2047 39/30 seconds BT 2057 35/27 seconds
	Boom head	Quick reeving
	Maximum sheave height	BT 2047 With optional 18–30 ft jib: 91 ft 9 in BT 2057 With optional 22–36 ft jib: 101 ft 9 in
	180 degree non-continuous rotation or optional 360 degree continuous rotation	

Operator Controls and Operator Aid

	Hoist line pull	7,900 lb
	Rope diameter	1/2 in
	Breaking strength	27,000 lb
	Overhaul ball	6.25 US t
	1 Sheave block	10 US t
	2 Sheave block	15 US t
	1 part line	7,600 lb
	2 part line	15,200 lb
	3 part line	22,800 lb



Fully proportional independent outrigger controls



Electronic rated capacity indicator

Understructure



Front: "A-frame" link type

To outer edge of pad

17 ft 10 in

Rear: A-Frame

To outer edge of pad

10ft 2 in

Optional Features

- Two-stage jib
- Rotation resistant rope
- Multi-part load blocks
- Main hoist with 2 speed motor
- Heavy duty wood flatbeds
- Extra heavy duty wood flatbeds
- Extra heavy duty steel flatbeds
- Radio remote controls
- One-man or two-man baskets
- Hoist drum tensioner
- Continuous rotation
- Oil cooler
- Single front bumper outrigger
- Hydraulic hose reel
- Tool box

Effective Date: July 2012. Product specifications and prices are subject to change without notice or obligation. The photographs and/or drawings in this document are for illustrative purposes only. Refer to the appropriate Operator's Manual for instructions on the proper use of this equipment. Failure to follow the appropriate Operator's Manual when using our equipment or to otherwise act irresponsibly may result in serious injury or death. The only warranty applicable to our equipment is the standard written warranty applicable to the particular product and sale and Terex makes no other warranty, express or implied. Products and services listed may be trademarks, service marks or trade-names of Terex Corporation and/or its subsidiaries in the USA and other countries. All rights are reserved. Terex® is a registered trademark of Terex Corporation in the USA and many other countries.

Copyright 2012 Terex Corporation.

Terex Cranes, Global Marketing, Dinglerstraße 24, 66482 Zweibrücken, Germany
Tel. +49 (0) 6332 830, Email: info.cranes@terex.com, www.terexcranes.com



www.terexcranes.com

Brochure Reference: TC-DS-I-E-BT2047/BT2057-07/12



WORKS FOR YOU.™