

500 GMT-S1

Hydraulic Telescopic Crane



Transport Configuration TBA

Crane Carrier

Chassis

KRUPP 9-axle special purpose vehicle made of high-tensile fine-grain steel.
4-axle front frame, center turret with hydraulic quick release couplings for mounting front outrigger beams.
9th axle line swivel-mounted and removable

Engine

12 cylinder Daimler-Benz OM424 A, water-cooled, 3 90 kW (530 hp) at 2300 rpm
Tank capacity: 1000 l Diesel fuel

Transmission

Power shift gear box with torque converter
MAN transfer case with road and off-road range and differential lock
Auxiliary gear box for 4th axle

Suspension

1st - 4th longitudinal and transverse tie rod alignment with 2 each suspension cylinders providing +/- 150 mm suspension range
5th - 9th center pin mounted directly underneath outrigger beams, with 1 each suspension cylinder, allowing +/- 180 mm suspension range
8th + 9th axle lines separate lift axles

Axles

1st - 4th drive-steer axles with transverse differential lock
2nd + 3rd with additional interaxle differential lock
5th swivel axles arranged in pairs
6th - 9th swivel-steer axles arranged in pairs

Tyres

1st - 4th axle 8 tyres 14.00-24 PR 22 (STD)
5th - 9th axle line 40 tyres 8.25-15 PR 18

Brakes

Service brake:
Pneumatic dual circuit brake, acting on all wheels.
Permanent brake:
Retarder of the Allison power shift gear-box, acting on 1st - 4th axle
Parking brake:
Pneumatic spring-loaded brake acting on 3rd - 9th axle

Outrigger system

Three-point outrigger system operated hydraulically from both sides of center turret
1 outrigger cylinder located in front of 1st axle,
1 each outrigger cylinder at the swivel-mounted rear outrigger beams
2 rigging cylinders at the center turret
For four-point-outrigger base, 2 additional separately transported outrigger beams are mounted

Steering

ZF-hydraulic dual circuit steering system, including steering cylinders, engine driven steering pump, 2 axle-driven stand-by steering pumps.
Steering provided also with outriggers extended to 6 m and 16 m width, steering axles mechanically connected via tie rods

Driver's cab

All-steel cab, 2 adjustable hydraulically suspended seats, laminated front screen, combined independent and engine heating system with additional ventilation, control and operating instrumentation for travelling
*) 3rd adjustable hydraulically suspended seat, 1 folding berth

Safety devices

Electric levelling device at the center turret

Carrier electrics

Three-phase generator	28V / 55A
2 batteries	12 V / 180 Ah
Lighting system and signals	24 V

Performance characteristics

Road speed	approx.	65 km / h
Gradeability	max.	35 %
Turning radius		16.5 m

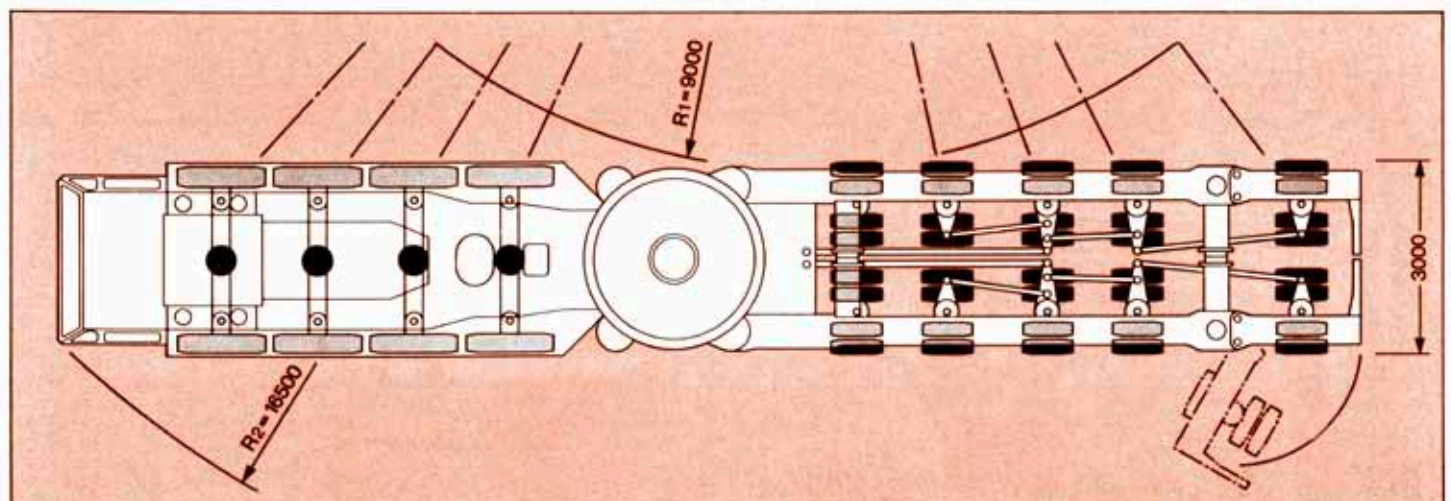
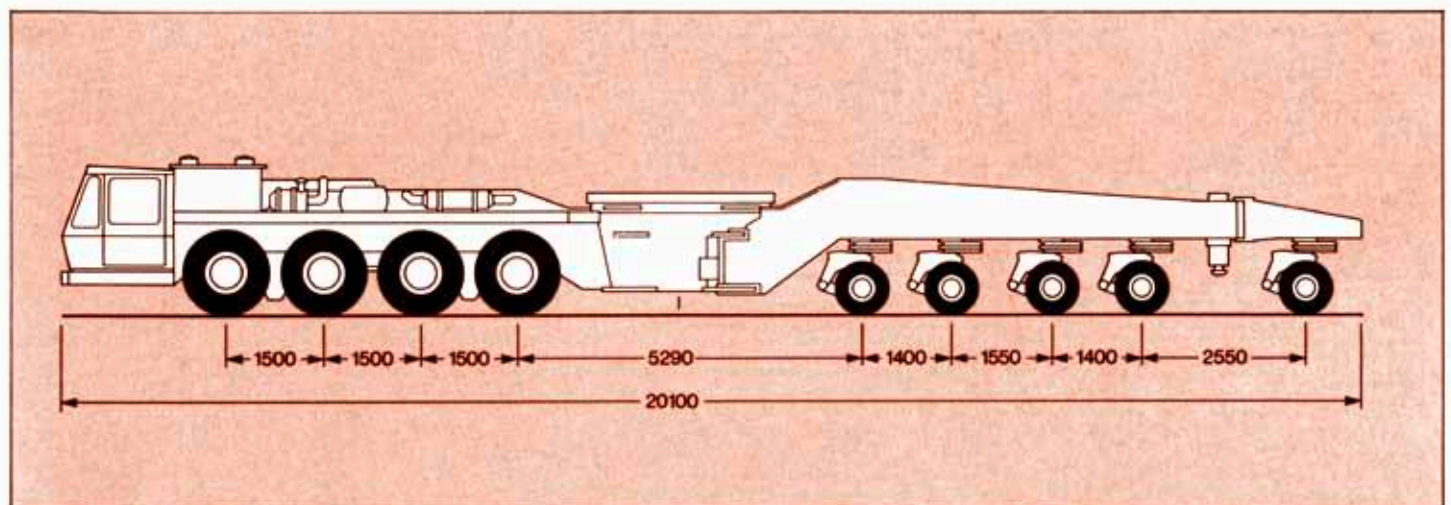

*) Additional equipment

Crane Superstructure

Crane engine

6 cylinder Daimler Benz OM 407 A, water-cooled
206 kW (280 hp) at 2200 rpm
Tank capacity: 300 l Diesel fuel

Hydraulic system

3 separate circuits:
2 axial piston pumps with integrated infinitely variable speed and load control, 1 axial piston pump, oil cooler
Tank capacity: 4000 l hydraulic oil
Hydraulic quick-release couplings for connecting boom, telescopic boom sections and auxiliary hoist

Operator's cab

Spacious all-steel cab, full vision, mounted on the left-hand side of superstructure, safety glass, door and side-wall with sliding window, tinted roof screen
Hydraulically suspended adjustable seat with arm- and head-rest
Variable cab positioning, hydraulic swing and tilt control

Control system

Sensitive and infinitely variable control of all crane motions by means of hydraulic pilot circuit and control lever returning automatically to dead-man-position. Conveniently arranged control and operating devices

Derricking system

Dual cylinders with pressure compensated control valve for lowering boom
Boom angle - 1° to + 83°
Derricking speed 5,8 min. high speed 3,8 min.

Main hoist

Axial piston constant motor with planetary gear and automatic brake
Winch pull max. 166 kN (17 t)
Single line speed max. 89 m/min.
Drum diameter 630 mm
Specially grooved hoist barrel
Rope diameter 27 mm
Rope length 630 m

Auxiliary hoist

mounted on basic counterweight
Axial piston constant motor with planetary gear and automatic brake.
Single line pull max. 102 kN (10,4 t)
Single line speed max. 114 m/min
Drum diameter 550 mm
Rope diameter 24 mm
Rope length 650 m

Rigging Drum

Axial piston motor with gear-box
Line pull max. 29 kN (3,0 t)
Line speed max. 50 m/min
Drum diameter 305 mm
Rope diameter 10 mm
Rope length 280 m

Counterweight

in sections, split for separate transport:
5 m long x 2,4 m wide
1 basic counterweight including auxiliary hoist = 20 t
4 additional counterweights @ 20 t = 80 t
Total counterweight including support = 100 t
Counterweight lift cylinders for 80 t weight in carrier

Safety installations

Hoist limit switch, rope limit switch, pressure relief valves, check valves.
KRUPP electronic load moment safety device with automatic cut-out and instrumentation for load, radius, boom length and boom angle.
Electronic slewing range monitor
Electronic levelling display
Limit switch for boom locking system
Hoist drum rotation indicator

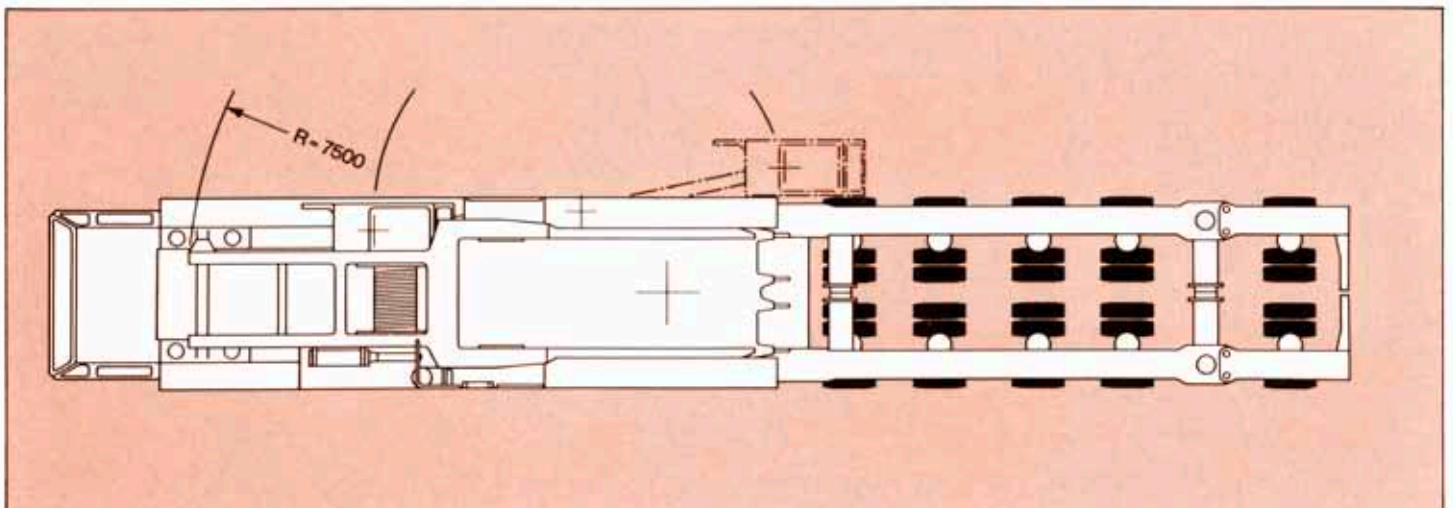
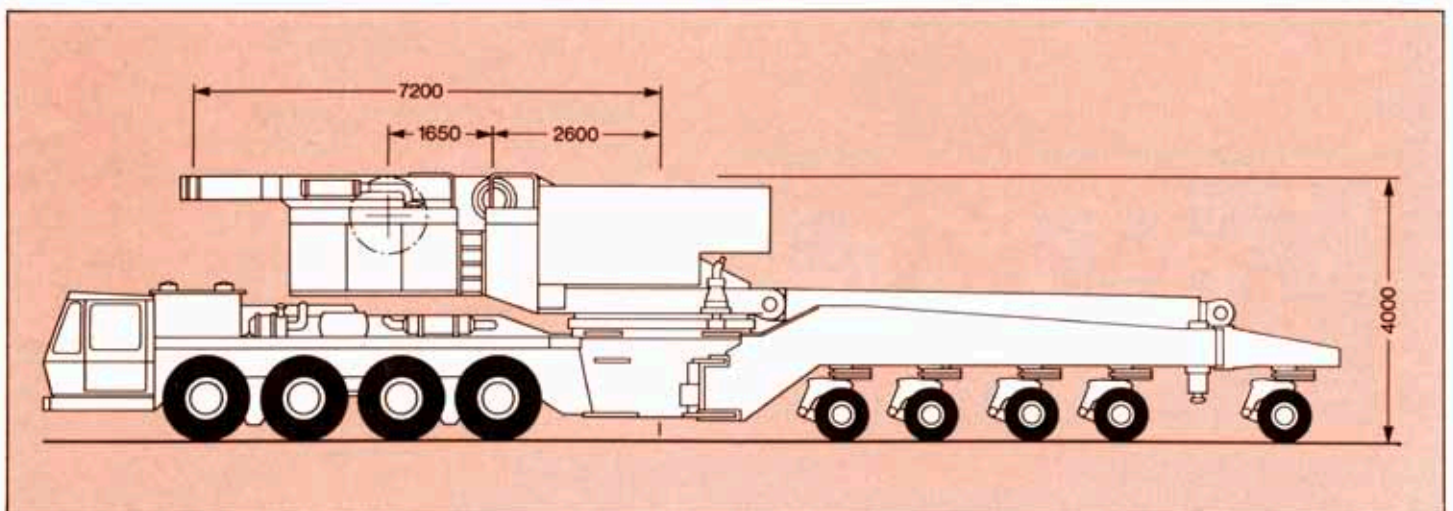

*) Additional equipment

Slewing gear

2 axial piston constant motors with planetary gear, holding brake and service brake
 Slewing speed 0 - 1,0 rpm infinitely variable

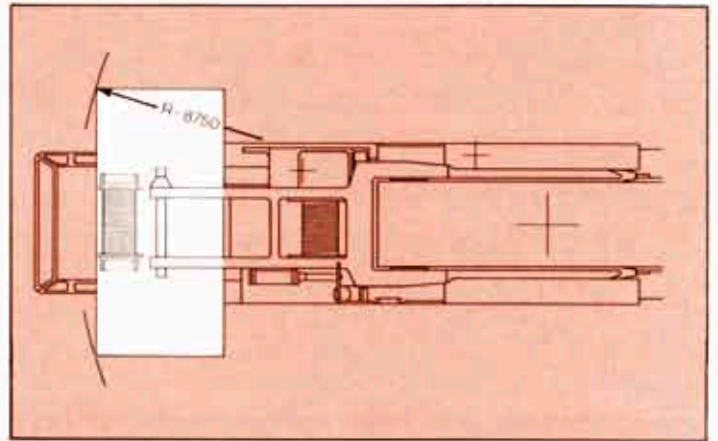
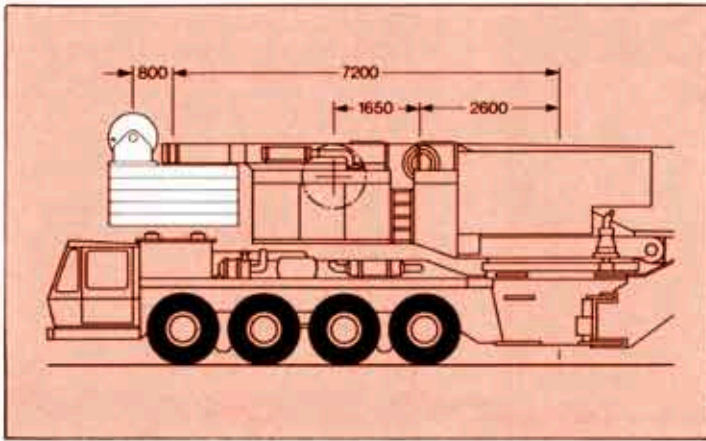

Telescopic boom

KRUPP welded boom sections fabricated of high-tensile fine grain steel, consisting of basic section and three full-power telescopic sections

Boom lengths:

18,6 m - 31,4 m - 44,2 m - 57,2 m

total length fully hydraulically extending under partial load

Telescopic system consisting of a telescopic cylinder of 12,8 m stroke and incorporated oil supply by-pass to 2-stage cylinder for 2nd and 3rd boom section with 2 x 12,8 m stroke. Remote control boom lock system for main hook and luffing jib duties.

Telescoping time:

1st section	180 sec	2 + 3rd	260 sec
high speed	120 sec	high speed	170 sec

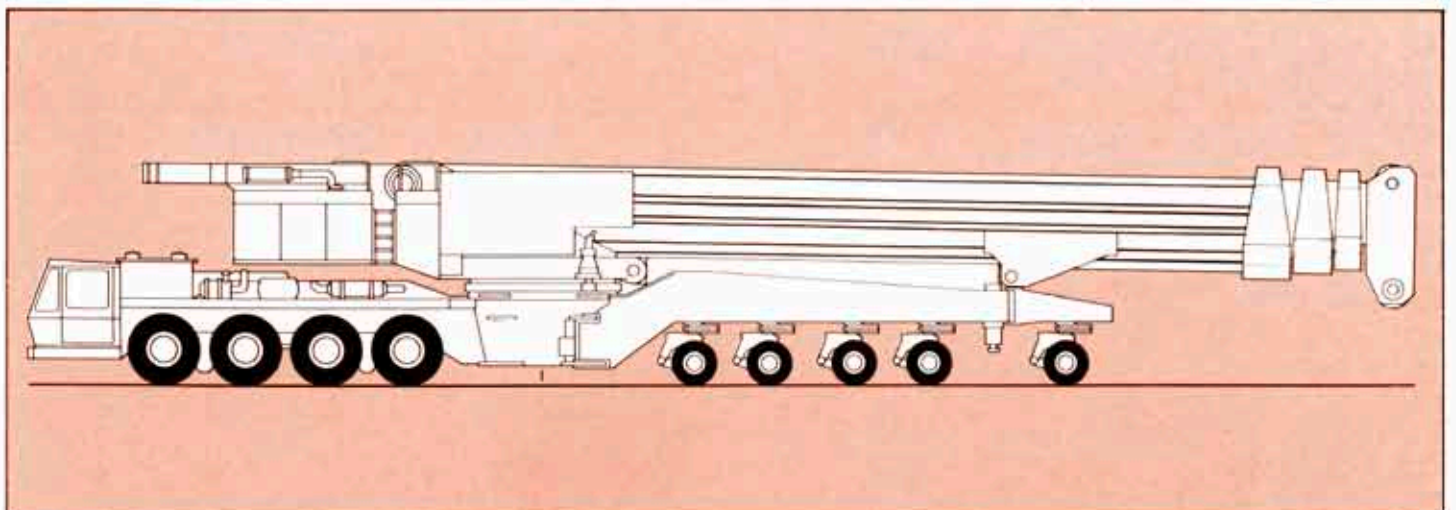
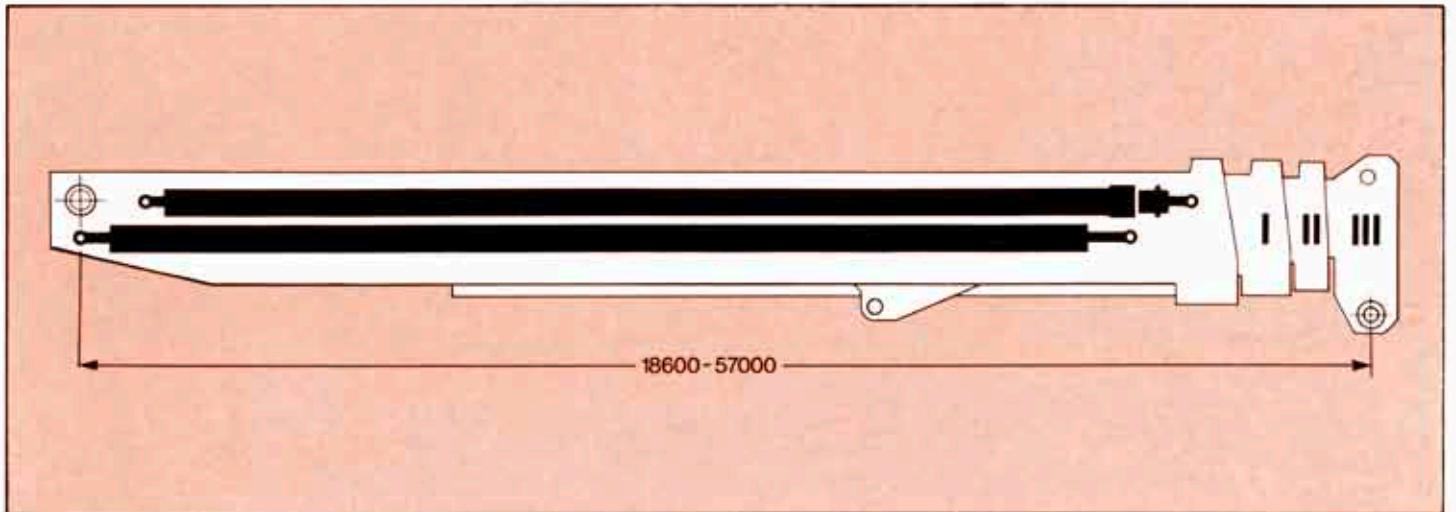

Travelling Trims

- 1) Road travelling trim with basic boom section.
Transport weight approx. 100 t.
Road speed max. 65 km/h.
Separate transport of the 3 boom sections
Necessary special equipment:
Hydraulically operated disconnecting and coupling device for the telescopic cylinders
- 2) Crane vehicle complete with four boom sections 57m.
Transport weight approx. 150 t, road speed reduced.

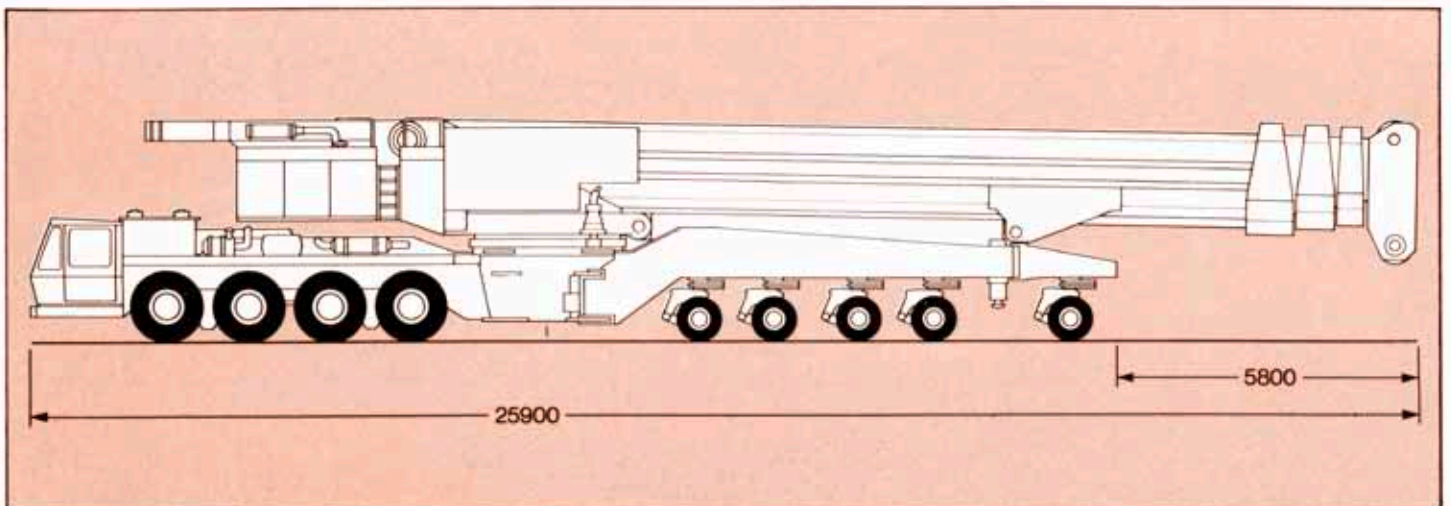
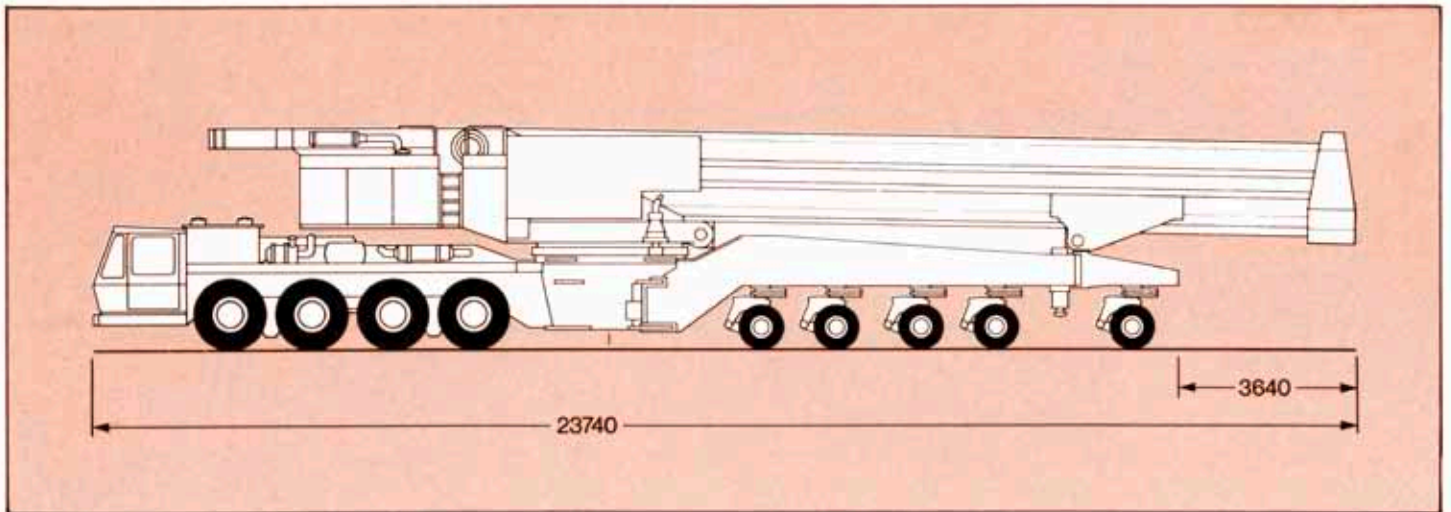

Travelling Trims on Site

The steering system allows site travel with 3 m, 6 m and 16 m rear outrigger width by simple mechanical change-over during straight travel.

The crane can be shifted on its own axes on the rigging site, upon mounting boom, counterweights and fly-jib.

Depending on rigging extent, driving and steering facilities are provided within 3 different rear outrigger positions.

Technically admissible travelling speed, crane fully rigged, up to 1 km/h.

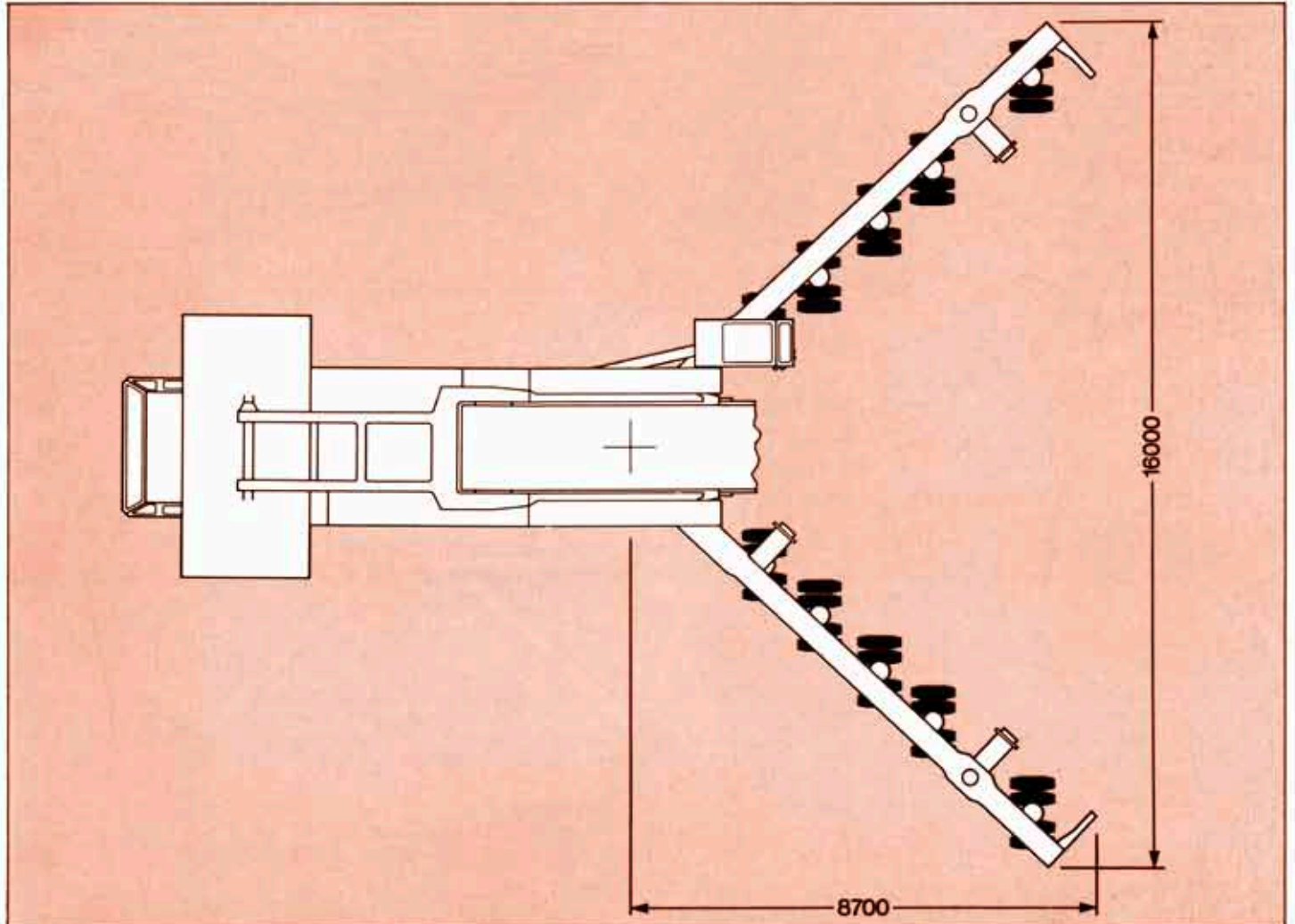
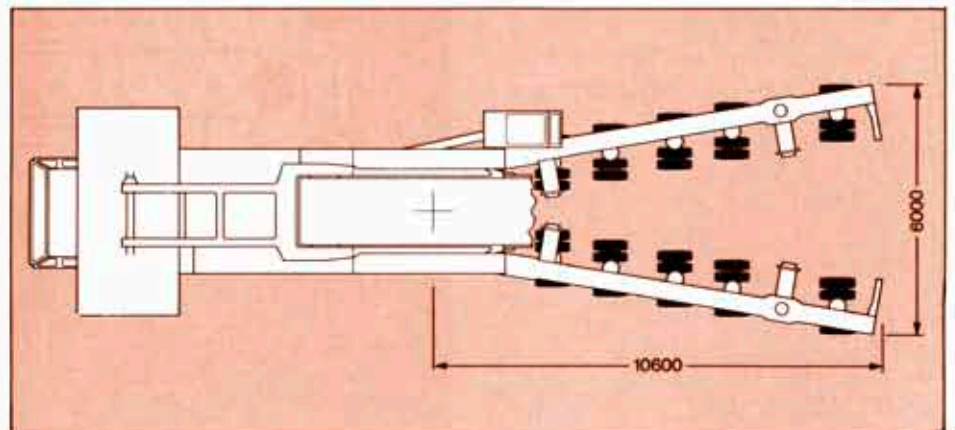
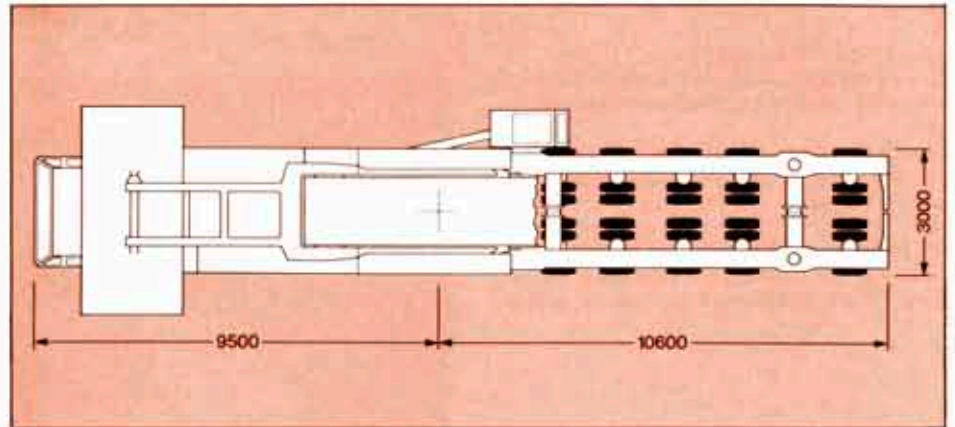

Outrigger System

For fast operations, crane work is possible on a three-point-outrigger-base either for lift duties 70/180° over rear (A).

Heavy duty and 360° lifts require the four-point-outrigger-base (C). For this purpose, 2 additional hydraulically operated outrigger beams have been bolted to the turret.

*4 additional outrigger girders for maximum duties. The 2 additional outrigger beams and 4 outrigger girders are transported separately.

With the standard support plates, remaining on the crane, the vehicle width does not exceed 3 m. Depending on loads and nature of the ground, additional support plates are necessary.

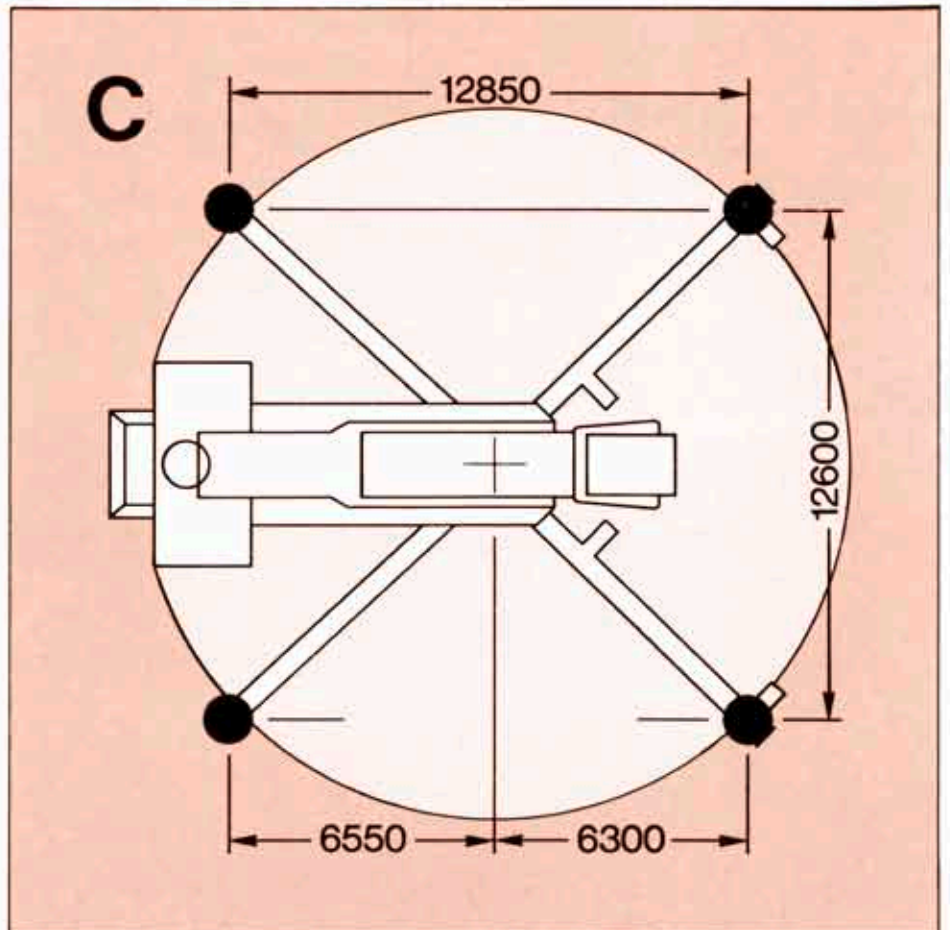
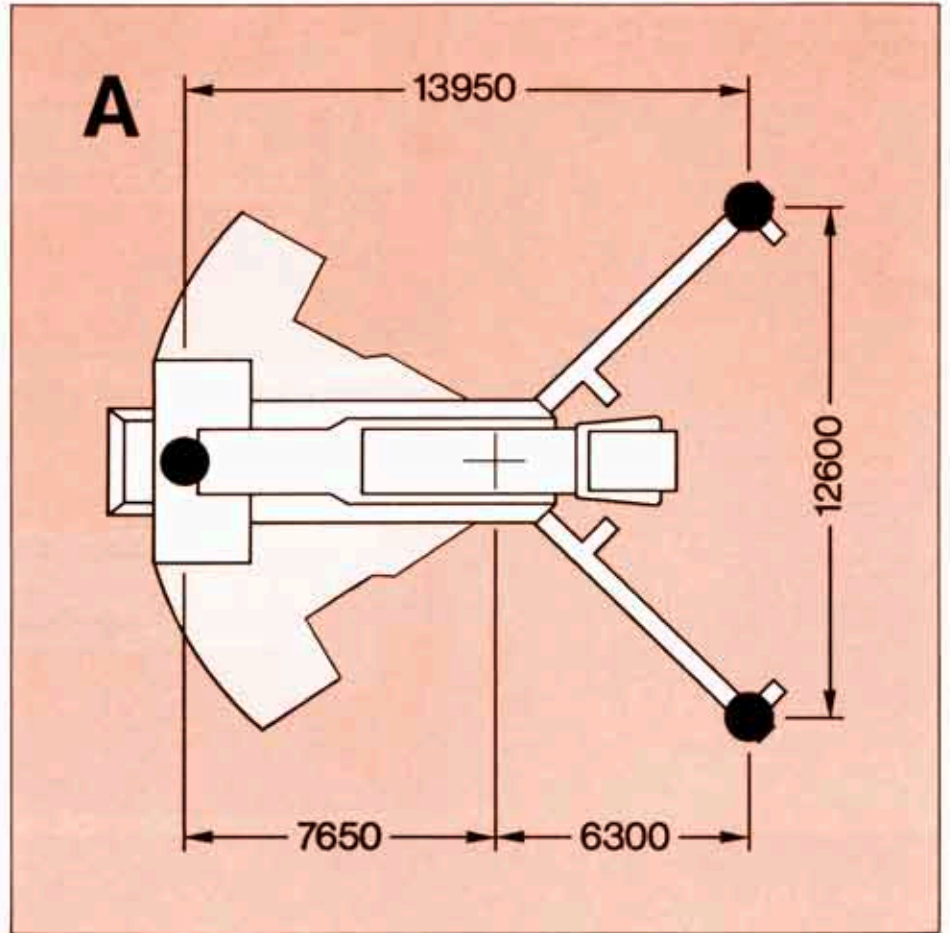

Jibs

Boom extension

In sections of 6 m from 10 m to 28 m, welded lattice-type construction

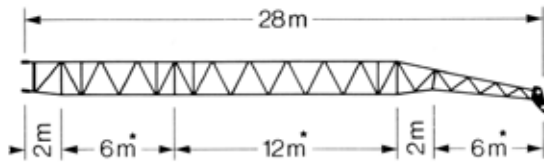

Luffing fly-jib

In sections of 6 m from 18,0 m to 72,0 m, welded lattice type-construction, including luffing fly-jib adaptor, A-frame, back-stop, pendant ropes, luffing block and anemometer
For luffing fly duties, the auxiliary hoist is mounted on the base counterweight

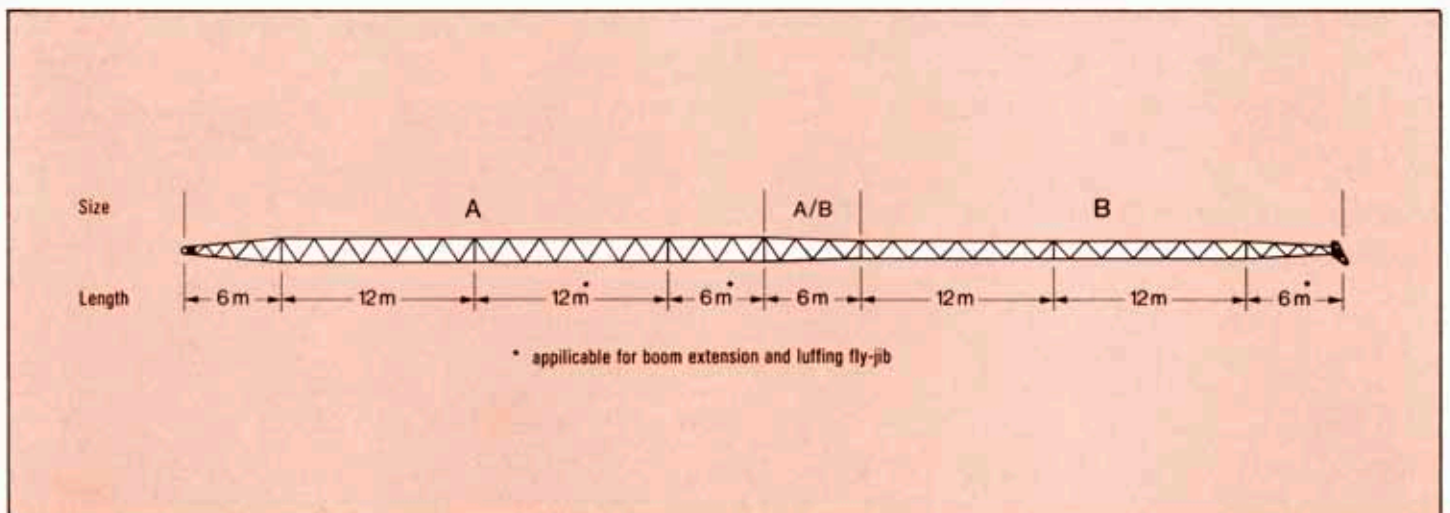
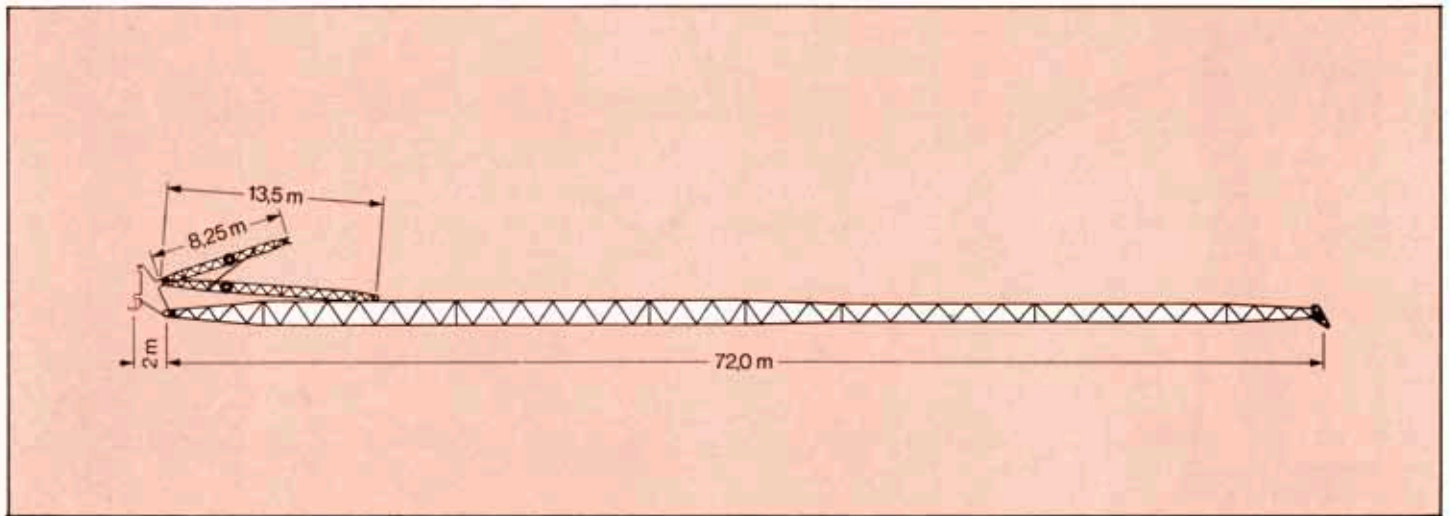
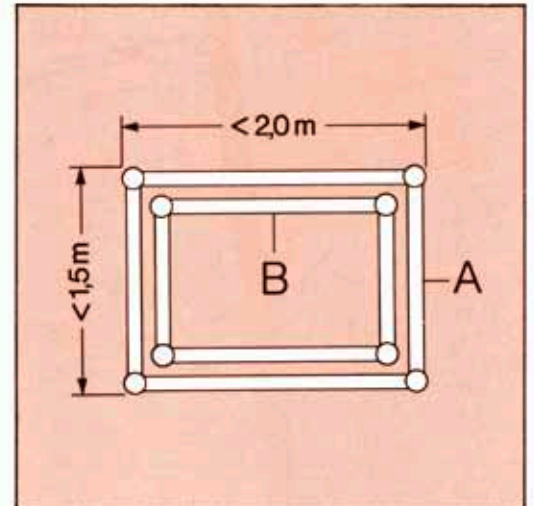

Range of Operation

Main boom
Lifting capacity (t) Counterweight 100 t

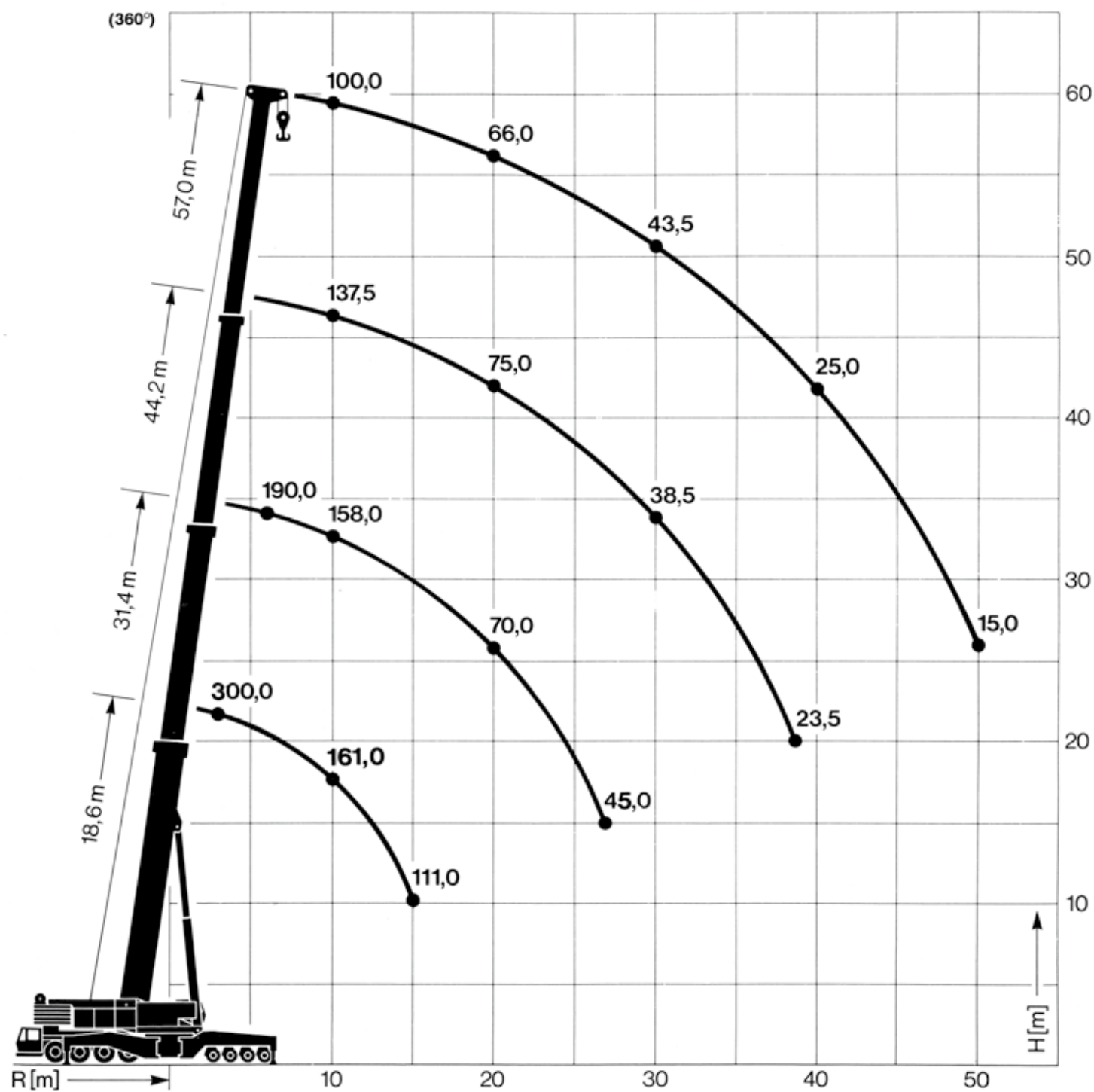

Hooks

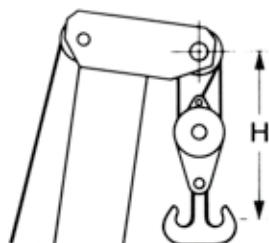

Capacity	t	250	125	60
Sheaves		10	5	3
Distance H	m	3,6	3,5	3,4
Weight	t	6,1	3,7	1,8

Lifting Capacity (t)

Notes

Lifting duties -

payload + suspending device + hook

ASA: Lifting capacity ASA1418

Boom: Telescopic sections mechanically locked standard-boom head 10 sheaves

lifting capacities above 220 t with additional equipment

1) Counterweight (t)

2) Outrigger base 7,7 x 7,7 m with additional outrigger girders

3) Backward

..... Limit between static stability (above) and tipping stability (below)

Main boom Outrigger base 12,85 x 12,60 m **C**

Radius (m)	Boom length (m)											
	18,6			31,4			44,2			57,0		
	Boomhead height max. (m)											
	22,0			34,6			47,3			60,0		
	1)	100 2)	100	80	100	80	100	80	100	80	100	80
		AS	AS	AS	AS	AS	AS	AS	AS	AS	AS	AS
3		500,0 3)	300,0	290,0								
3,5		400,0	300,0	290,0								
4		380,0	300,0	290,0								
5		331,0	264,0	257,0								
6		288,0	234,0	230,0	190,0	190,0						
7		258,0	210,0	207,0	190,0	190,0						
8		230,0	192,0	188,0	189,0	185,0	140,0	140,0				
9		200,0	175,0	172,0	172,0	169,0	140,0	140,0				
10		177,0	161,0	157,0	158,0	155,0	137,5	137,5	100,0	100,0		
12		130,0	137,0	135,0	134,0	130,0	120,0	120,0	91,0	91,0		
14		100,0	118,0	112,0	115,0	107,0	106,5	106,5	84,0	84,0		
15		88,0	111,0	102,0	105,0	98,0	101,0	101,0	80,5	80,5		
16					97,0	89,0	96,0	93,5	77,5	77,5		
18					82,0	76,0	87,0	79,5	71,5	71,5		
20					70,0	64,0	75,0	68,5	66,0	66,0		
22					60,0	55,0	65,0	59,0	60,5	60,5		
24					51,5	47,0	57,0	51,5	55,0	55,0		
25					49,0	44,0	53,0	48,5	53,0	53,0		
26					45,0	40,0	50,0	45,0	51,0	50,0		
28					39,5	33,0	44,0	39,5	47,0	44,0		
30							38,5	34,5	43,5	39,0		
32							34,0	30,5	39,5	34,0		
34							30,0	26,0	35,5	29,5		
36							26,5	22,0	31,5	26,0		
38							23,5	19,0	28,0	23,0		
40							20,5	16,0	25,0	20,5		
42									22,5	18,0		
44									20,5	16,0		
46									18,0	14,0		
48									16,5	12,0		
50									15,0	10,0		

Range of Operation

Boom extensions
Lifting capacity (t) Counterweight 80 t

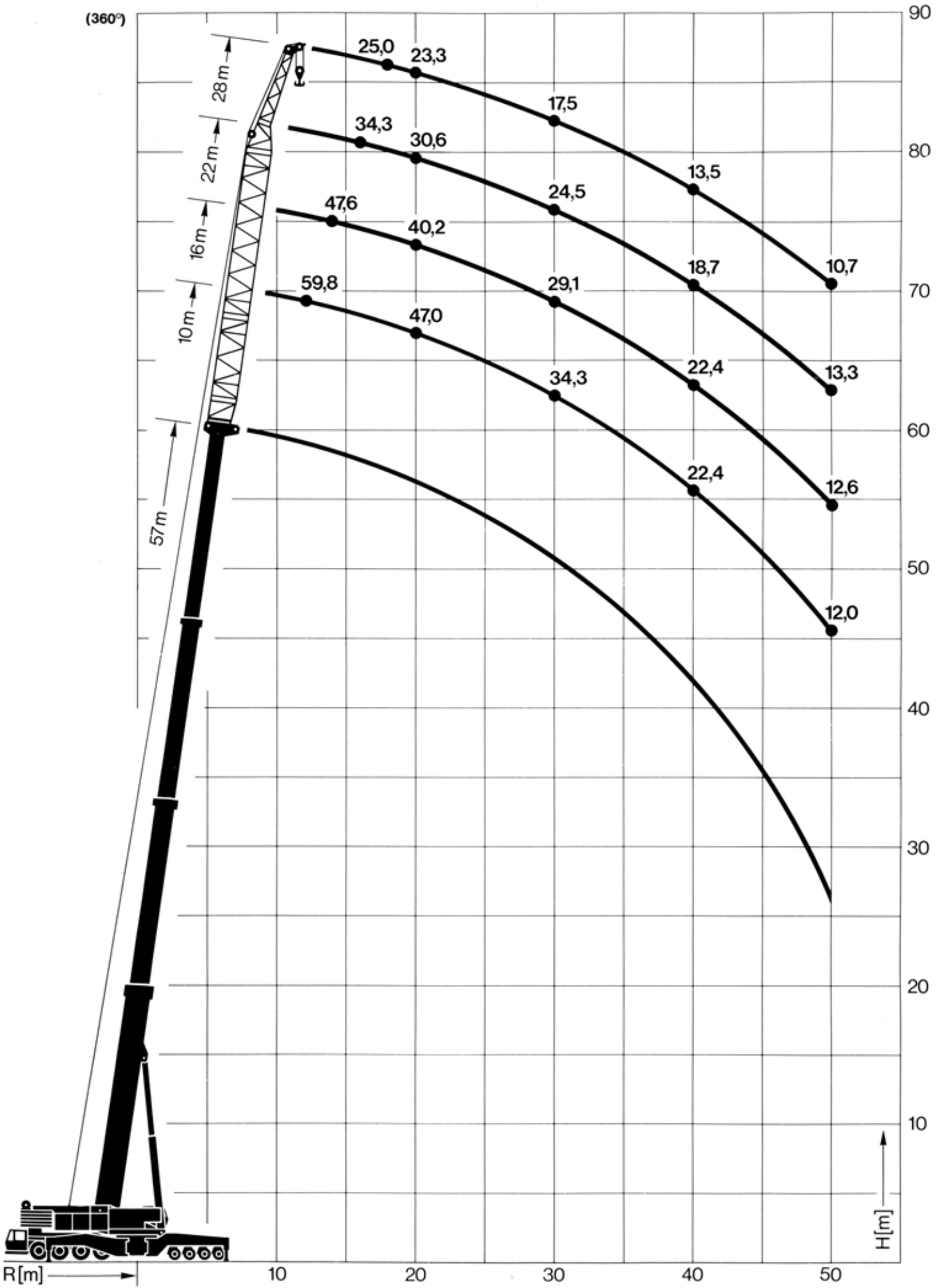

Lifting Capacity (t)

Notes

Lifting duties -

payload + suspending device + hook

AS: Lifting capacity ASA 1418

Boom: Telescopic sections mechanically locked

..... Limit between static stability (above) and tipping stability (below)

Boom extensions

Counterweight 80 t

Outrigger base 12,85 x 12,60 m **C**

Radius (m)	Boom length (m)							
	57 + 10		57 + 16		57 + 22		57 + 28	
		AS		AS		AS		AS
14		59,8		47,6				
16		54,8		44,8		34,3		
18		50,6		42,4		32,5		25,0
20		47,0		40,2		30,6		23,3
22		44,0		37,5		29,1		21,8
24		41,0		35,2		27,8		20,5
26		38,6		32,2		26,6		19,5
28		36,4		30,8		25,3		18,5
30		34,3		29,1		24,5		17,5
32		32,5		27,6		23,1		16,5
34		30,8		26,0		21,8		15,6
36		28,2		24,8		20,7		14,9
38		25,3		23,6		19,6		14,2
40		22,4		22,4		18,7		13,5
42		19,9		20,7		17,8		12,7
44		17,8		18,5		17,0		12,2
46		15,6		16,3		16,2		11,6
48		14,0		14,5		14,9		11,3
50		12,0		12,6		13,3		10,7

Range of Operation

Luffing fly jibs
Lifting capacity (t) Counterweight 80 t

