

National Series 500C



**A heavy-duty telescoping crane from National,
America's truck-mounted hydraulic crane leader**

- Maximum Capacity: 30,000 Pounds (13.6 Metric Tons)
- Maximum Vertical Reach: 115 Feet (35.1 Meters)

Why buy the ALL NEW National Series 500C telescoping crane?

Here are some excellent reasons . . .

- The new Series 500C is the premier crane of its class in the commercial truck-mounted industry.
- The Series 500C has extra-heavy-duty lifting power -- a rated capacity of 30,000 pounds (13.6MT).
- The 500C has extra-long vertical reach -- to 72 feet (21.9m) under hydraulic power.
- With the 43-foot (13.1m) jib, the 562C reaches up to a vertical height of 115 feet (35.1m).
- A split (two-piece) removeable front console cover allows fast and easy access to valves and wiring.
- The improved high-performance winch with enhanced meterability allows precise load placement.
- Upgraded state-of-the-art automotive-type wiring with shrink wrap terminal connections helps prevent corrosion and improves the reliability of wiring throughout the crane.
- Two lower sheaves in the sheave case allow four-part reeving (with optional block) without attaching an additional sheave at the end of the boom.
- No counterweight is required with RSOD outriggers.
- A new hydraulic capacity alert system halts crane functions when capacity is exceeded on main boom (a new, state-of-the-art load moment indicator is optional).

And here are even more . . .

Field-proven durability

- National has manufactured cranes since 1963. Over 90% of all Nationals ever produced are still in operation.

Attention to quality

National never skimps on quality. The materials and components used in the manufacture of National Cranes often cost more -- sometimes significantly more -- than those found in competitive products. With a National, you get more for each dollar that you invest in a crane.

Industry-leading test program

- Each prototype model must pass the stringent structural test requirements of SAE J1063 and the stability test requirements of SAEJ765.
- National's test program subjects all prototype cranes to state-of-the-art strain gauge testing, a procedure that measures metal deformation as small as one-millionth of an inch. These and the test procedures noted below verify the structural integrity of the cranes that National manufactures.
- Prototype cranes must undergo National's life-cycle tests, the toughest in the industry. They

receive more punishment than most cranes encounter in a lifetime of rigorous, on-the-job use. Every structural part of the crane is cycle-tested. Some components are operated through 60,000 cycles at full capacity load. The process requires thousands of working hours and takes months to complete.

- Boom corner seam welds on all Nationals are ultrasonically tested to verify proper boom weld penetration.

Rigid quality controls

- Each Series 500C undergoes numerous quality inspections at all levels of manufacture and assembly. No crane is shipped without a rigid final inspection.
- Component manufacturers are critically reviewed by National's senior management before they qualify as suppliers of parts.
- Inspections of incoming materials and components ensure that purchased items meet National's standards.
- Material compositions are maintained and steel composition is regularly verified.
- All structural welders at National must pass AWS welder certifications.

More value for your investment

- Nationals consistently have the highest resale value in the industry. You will realize a greater return on your investment when you trade or sell your used National.

Uncompromising Standards Unequaled Performance

Responsive service and parts support

- Each Series 500C is backed by strong after sale and service support. National's professional dealer network is worldwide. That means that service and repair resources are ever near, wherever you may be operating your National.
- The typical National dealer has been associated with National for more than eleven years. He knows the product.
- Authorized National dealers maintain a parts stocking program for your crane. That means when your Series 500C needs parts or service, it will be back on the job without undue frustration or delay.
- When a dealer cannot immediately supply a part for your Series 500C, the factory can. National is committed to providing 24-hour parts shipping in 92% of all breakdown rush orders.

The National Service Center

- National maintains a fully equipped Service Center at the plant to handle factory crane mounting and special crane modifications or repairs. Most dealers can handle all but the most unusual or serious service/repair requirements.

Efficient boom design

- National's computer-aided structural design system utilizes sophisticated, state-of-the-art software programs such as "Finite Element Analysis" to analyze and

accurately predict the structural behavior of a machine or crane component prior to the actual manufacture of the unit. National's boom program mathematically calculates boom stress factors, allowing National engineers to determine boom competence during the design process. This computer program enables National engineers to maximize the weight efficiency of Series 500C booms, thus enhancing crane capacities. All engineered parts are detailed on the computer. The program assures accurate fits in every phase of the manufacturing process.

- The boom sections are fabricated from four high-strength steel members welded with perpendicular corners.

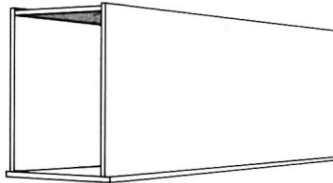

This "box-section" design (shown above) utilizes thicker top and bottom plates to enhance boom strength and thinner side plates to increase the crane capacity through lower boom weight.

- Only high-strength, low-alloy steel is used in boom fabrication.
- Welds are made with automatic, low-hydrogen techniques to provide strong fatigue-resistant seams.



Stronger, more efficient sheaves

- The sheaves on the Series 500C consist of iron, not plastic (as is used on most competitive cranes). Iron sheaves provide greater strength and longer wear, resist flange chipping, and help prevent core damage to the wire rope.
- Two lower sheaves in the sheave case allow for four-part reeving (with optional block)

without attaching additional equipment at the end of the boom.

Three section proportional boom extension system

- The Series 500C is available in three models. Each is equipped with a three-section proportional boom extension system. Model 562C is standard. Models 547C and 538C are available when less reach is required.

National Series 500C

- Dual high-load-carrying cables cycle the third stage boom on the Model 562C crane. The other section is supported by the hydraulic cylinder. Redundant cable sets are used for durability and reliability. The internal bearings and cable require no lubrication.
- Proportional (cable crowd) boom design (each boom extends and retracts proportionally during the telescoping operation) provides more efficient boom weight distribution, maximizing boom operational efficiency and allowing higher capacities, particularly in normal working radii.
- The design permits minimum overlap to get the most reach with minimum retracted length. It reduces boom overhang (when the boom is stowed) and allows increased truck maneuverability.
- The use of cable (rather than chain) means more capacity, longer service life, and less maintenance.
- There are no fittings, tubes, or hoses inside the booms, and since the system utilizes only one extend cylinder, hydraulic maintenance is minimized.

"Easy Glide" boom wear pads

- Series 500C booms are equipped with National's unique "Easy Glide" wear pads, a technology pioneered by National's engineering group.
- These pads reduce the conditions that cause noisy boom chatter and vibration.
- They feature an innovative self-lubricating capability that deposits and maintains a long-lasting film on boom sections and wear pad surfaces. This results in a smooth, reduced friction boom in/out movement during the extend/retract modes of operation -- even at slow operating speeds.
- While these uniquely efficient wear pads do not completely eliminate the need for routine greasing of boom surfaces, they enhance a smooth and quiet crane operation, reduce wear and tear on the unit, reduce maintenance, and are easy to replace.
- The wear resistance of the material in "Easy Glide" wear pads is unexcelled.

Direct mount holding valves

- On the Series 500C, all load-carrying cylinders are equipped with a direct mount holding valve for protection in the event of hose failure. The quiet, smooth, and stable new boom cylinder holding valve ensures a precise load placement capability with the boom.

National-manufactured cylinders

- Because National controls the manufacture of its own lift, outrigger, and stabilizer cylinders and the packing used as the seals, standardization is ensured and seal replacements fit properly.

High performance planetary winch

- The standard high-performance gear drive winch increases efficiency, requires less horsepower, and generates less heat.
- The Series 500C winch is powered by a premium, high-efficiency orbit (geroller) motor instead of the gear motor typically used on competitive cranes. The orbit motor used with National's high performance winch, allows for extra-smooth control, up or down, even under maximum load.
- Anti-friction roller bearings have replaced bronze bushings, and spring-loaded lip seals

have replaced O-rings to reduce leaks and maximize winch efficiency.

- A "Burst-of-Speed" feature for faster, more efficient pay-out and pick-up of unloaded cable is optional on the Series 500C. The "Burst-of-Speed" winch circuitry increases line speed up to 60% over normal.
- The high-capacity winch used on the Series 500C features high line pull and fast standard speed (see the winch data chart on page 9).
- Standard brake and counterbalance valves provide fine control.
- The winch cover permits visibility of the drum and cable.
- Die-drawn rotation-resistant wire rope (cable) is standard on the 500C. Even under full load, die drawn wire rope minimizes spinning and twisting. Lifting operations are more precise and no time is wasted untangling the line. Die-drawn cable has a longer usable life span.





Anti two-block system

- The Series 500C is equipped with a standard anti-two-block system. Two blocking occurs when the winch cable and attachments contact the underside of the boom or jib sheave case, whether by winching up or extending the boom without paying out the winch cable. When this happens, the cable can be damaged by crimping or overextending. The anti-two block attachment helps prevent cable damage by sensing the position of the winch cable end attachments with respect to the sheave case and shutting down the functions that can cause two-blocking.

Hydraulic capacity alert system

- A new hydraulic capacity alert system (HAS) is a hydraulically operated, maximum capacity sensing device with indicator lights, memory-keyed override switches, and color-coded load indicator gauges at each console. The system, standard on the 500C, is designed to stop crane functions when maximum capacity is exceeded on the **main boom**. This system is not applicable for jib or basket use or for stability capacities.

Positive planetary turret rotation

- The planetary rotation gearbox with a hydraulic release brake and a slip-through feature allows the gearbox to backdrive when excessive side load is applied to the boom, reducing shock loads on the upper and lower crane structure and gearbox. This feature helps protect the rotation system against damage from accidental side loading.
- The turret drive is designed with extra heavy bearings below the drive pinion. The turntable bearing full-circle bolt pattern extends the bearing life due to uniform loads on the bearing.

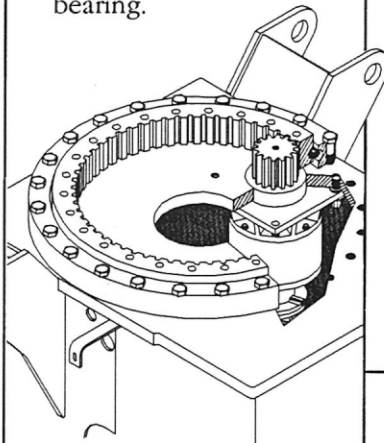

- The gearbox and rotation bearing mounting surfaces are precision machined after welding to ensure consistent tooth alignment for smooth rotation and low wear, even under maximum loads.
- The entire turret glides smoothly on a low-inertia ball bearing race.
- Rotation is 375° non-continuous. The rotation stop design eliminates the sudden stop on noncontinuous rotation machines by gradually slowing the rotation of the boom. Continuous rotation is available.

Solid, reliable stability

- Wide 19-foot 4-inch (5.9m) span A-frame out-and-down outriggers provide stable, efficient leveling, even on uneven ground. Large 18-by 18-inch (450 by 450mm) outrigger pads are standard.
- The outriggers retract smoothly without binding under load, first moving up, then in (see diagram below).

- the outrigger and stabilizer hydraulic power is sufficient to level a fully loaded truck.
- With less truck weight you can carry larger payloads more economically.



National's A-Frame "Out-and-Down" Stable Outriggers

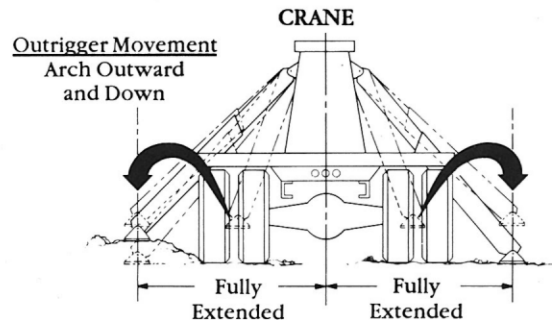

- Outriggers equally spaced from crane center line.
- Consistent outrigger span
- Crane will be equally stable on both sides.
- No skidding the foot into position.

National Series 500C (Continued)

- The 500C is equipped with ASH rear hydraulic stabilizers with a 10-foot (3.07m) span.
- Series 500C stabilizers are designed to lift and level -- or lower -- a loaded truck without sticking or binding. Hoses are routed along the beam to prevent hose damage during the operation of the crane.
- Stabilizer foot pad size is 6.5 by 11 inches. Leg travel is 20 inches, permitting good penetration with maximum ground clearance.
- A precision-mounted level indicator aids the operator in leveling the unit during the set-up procedure.

Smooth, "operator friendly" crane controls

- Dual controls are standard on the Series 500C. Identical crane functions are located on each side of the crane. The controls are in an SAE recommended orientation of functions. That means that you always work the same control with the same hand.
- Dual stations provide more efficient operation of the crane and allow greater load visibility.
- Control rods supported by nylon bearings permit smooth operation of the crane and reduce lubrication requirements.
- National's control valves are custom manufactured to maximize the efficiency of each crane function. They afford the ultimate in fine metering and low

- spool force. The operator can winch a capacity load up or down in small increments of distance and can control all crane functions precisely and smoothly.
- The main control valve and the lift cylinder holding valve are designed to complement one another, minimizing boom bounce and hydraulic noise.
- Cleanly engineered electrical line routing prevents damage during crane operation and service. All electrical ends are crimp and shrink wrap sealed. There are no spade connectors on the 500C.
- Labeled knobs make it easy for the operator to determine the function of each control.
- The pressure gauge on the console permits the operator to monitor the hydraulic system pressure to ensure maximum performance.
- The 500C provides a precise leveling indicator at each control station. The level bubble brackets are machined

- to be parallel with the turntable bearing to properly level the unit prior to operation.
- A foot throttle, horn, and stop switch are located at each control station.
- The operator's stations are positioned to allow easy reading of the angle indicator showing the boom angle during operation.

- The platforms are located to give the operator excellent visibility of the load as well as convenient access to the bed. They are designed with open-mesh expanded metal to minimize dirt and mud buildup.
- Extra high back rests at operator control stations aid in operator control and comfort.

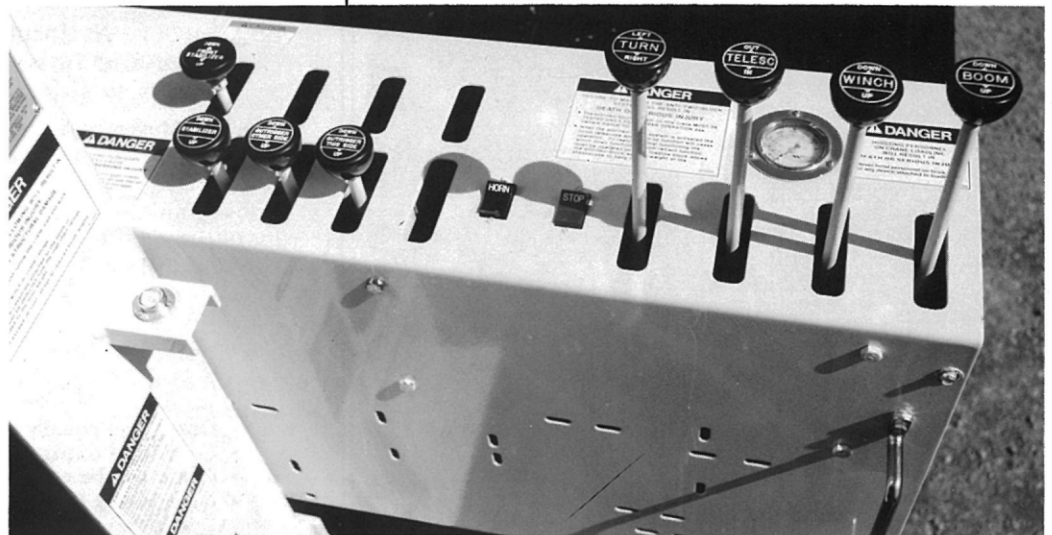

Heavy-duty hydraulic system

- A high pressure/high speed, balanced vane triple pump system provides smooth, fast, simultaneous hydraulics. The winch and rotation are isolated from other crane functions for easy, independent operation, and increased productivity on high cycle jobs. The replaceable cartridge design greatly simplifies repairs. Contact the factory for continuous duty cycle applications.
- Control valve spools are hard, chrome-plated for long life and resistance to corrosion. All spools are selected and hone-fitted for minimum internal leakage and for maximum load-holding ability.

Unitized Mounting

- National's unitized mount includes a one-piece, 8-inch deep sub-base that extends along the frame and supports the crane and bed. It reduces counterweighting and increases stiffness and stability.
- Reinforcing is not required on trucks with 13.3 inch³ (15.9-inch³ for 360° stability) section modulus frames of 110,000 PSI minimum yield steel. The crane and subbase ship separately, then bolt together to form one solid integrated unit.

Lower truck requirements

- The Series 500C is engineered to lower your truck requirements. The wide outrigger span, ASH rear stabilizers, and unitized mount take the stress (so the truck doesn't have to).
- That means that the 500C can mount on trucks with lower axle ratings and still meet DOT and industry stability standards with ease. It all adds up to lower maintenance, lower costs, and longer truck life for you.
- The Series 500C with subbase mounts on most standard, heavy-duty commercial trucks without requiring counterweight.

Easy service, low downtime

- The split console cover allows easy one man access to control valves.
- Boom pivot and lift cylinder bearings provide longer life and lower maintenance.
- Rear boom access provides easy access to wear pads and holding valve for easy maintenance.



- The rotation drive and the brake are located inside the frame. A large access hole allows easy access for service.
- O-ring face seal fittings are used on all high pressure circuits to minimize fluid leakage.
- Main pins are chromed to inhibit rust and allow easy removal.
- Greaseless bearings are used throughout to reduce maintenance.
- Extra-capacity (75-gallon) oil reservoir with sight gauge, breather, suction strainer, clean-out, and magnetic plug reduces heat buildup and keeps the hydraulic oil clean, ensuring ease of maintenance and long machine life. The aluminized reservoir prevents the gathering of rust in the system.

The National Warranty

- The National Warranty covers your crane against defects in materials and workmanship for six months from the date of shipment, subject to the conditions of the warranty.

Versatile accessories

- A selection of boom/jib combinations (see following page) allows you to tailor your Series 500C to your job needs.
- A complete accessory line adds to the versatility of the Series 500C. See page 18 for details.

National Boom Rests

Cranes are tough when they are in use, but they can be severely damaged during travel from job to job. The only way a crane can be protected from this type of wear and damage is a strong, solid boom rest.

A boom rest:

- Adds years to the life of your crane
- Reduces stress on the crane frame
- Protects rotation gear from transit damage
- Removes stress from truck frame
- Spreads crane load more evenly
- Reduces maintenance and downtime

In addition, a boom rest is required to provide a positive way to immobilize your crane for transit.

National Crane supplies three heavy-duty boom rests for strong, sure protection of your crane. There is a quality boom rest to fit your mounting configuration. All National cranes must be fitted with a boom rest. All factory mounted cranes will be supplied with a boom rest.

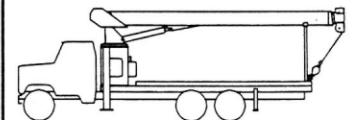

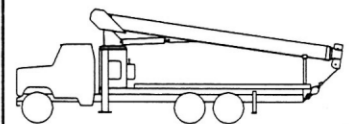

Fixed or removeable horizontal rear mounts for greater load space



Low profile rear bed mount for lower center of gravity

National Series 500C Booms and Jibs

Boom and Jib Combinations

562C: 24-62 ft. three section	
562C: 24-62 ft. three section	5FJ24: 24 ft. single section
562C: 24-62 ft. three section	5FJ43M: 24-43 ft. manual pullout
547C: 19-47 ft. three section	
547C: 19-47 ft. three section	5FJ15: 15 ft. single section
547C: 19-47 ft. three section	5FJ25M: 15-25 ft. manual pullout
538C: 16-38 ft. three section	
538C: 16-38 ft. three section	5FJ15: 15 ft. single section
538C: 16-38 ft. three section	5FJ25M: 15-25 ft. manual pullout

Reaches to 115 feet (35.1m)

The Series 500C is available in three basic models:

Model 562C

Model 562C comes with a 24-62 foot (7.3-18.9m) three section boom. This model reaches to a height of 115 feet (35.1m) when equipped with the 43-foot (13.1m) jib. It reaches to a height of 72 feet (22m) hydraulically.

Model 547C

Model 547C comes with a 19-47 foot (5.8-14.3m) three-section boom. This model reaches to a height of 82 feet (25m) when equipped with the

25-foot (7.6m) jib. It reaches to a height of 57 feet (17.4m) hydraulically.

Model 538C



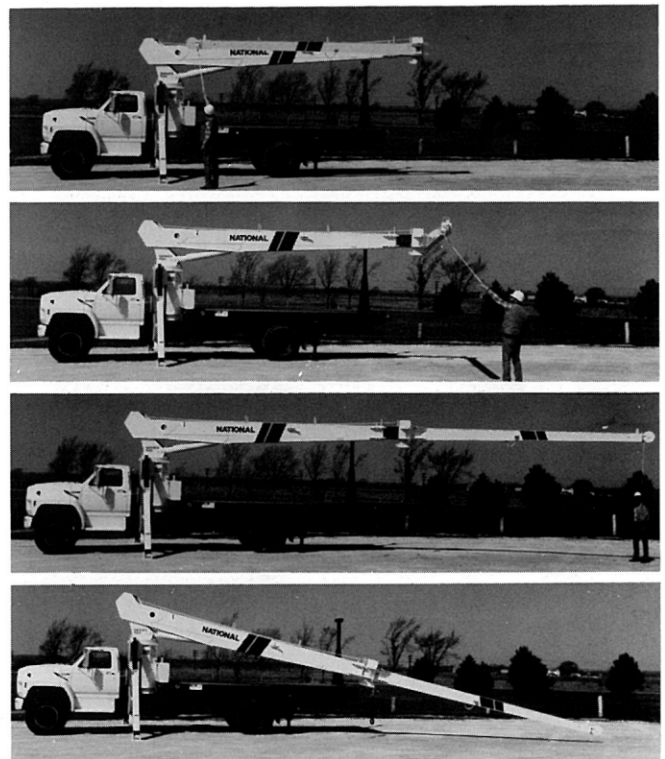

Model 538C comes with a 16-38 foot (4.9-11.6m) three-section boom. This model reaches to a height of 73 feet (22.2m) when equipped with the 25-foot (7.6m) jib. It reaches to a height of 48 feet (14.6m) hydraulically.

All models are available with the optional jibs shown in the chart above. An angling jib (5FJ15A) is available for the Series 500C. Other boom lengths are available on special request.



This sequence of photos shows how a National jib folds out into a working position.

National Series 500C Winch Data

National Series 500C Winch Data			1 Part Line	2 Part Line	3 Part Line	4 Part Line	5 Part Line
Caution							
<ul style="list-style-type: none"> Do not deadhead lineblock against boom tip when extending boom. Keep at least three wraps of loadline on drum at all times. Use only 9/16" diameter rotation resistant cable with 38,500 pounds breaking strength on this machine. Maximum capacity with optional "Burst-of-Speed" is 3,000 pounds. 							
Winch	Cable Supplied	Average Break- ing Strength	Lift and Speed	Lift and Speed	Lift and Speed	Lift and Speed	Lift and Speed
Standard Planetary Winch	9/16" diameter rotation resistant	38,500 lbs.	7,000 lbs. 143 fpm	14,000 lbs. 72 fpm	21,000 lbs. 48 fpm	28,000 lbs. 36 fpm	30,000 lbs. 29 fpm
	Optional 9/16" diameter 6x25 IWRC	29,750 lbs.	7,000 lbs. 143 fpm	14,000 lbs. 72 fpm	21,000 lbs. 48 fpm	28,000 lbs. 36 fpm	30,000 lbs. 29 fpm
With "Burst- of-Speed" Feature	Same as corresponding cable data shown above		3,000 lbs. 229 fpm	6,000 lbs. 115 fpm	9,000 lbs. 77 fpm	12,000 lbs. 58 fpm	15,000 lbs. 46 fpm

All winch pulls and speeds are shown on the third layer. Winch pulls would increase on the first and second layer. Winch line speed would decrease on the first and second layers. Winch line pulls may be limited by the winch capacity or the cable safety factor. These are shown below:

Winch	Bare Drum Pull	Allowable Cable Pull
With standard rotation resistant rope.....	9,380 pounds.....	7,700 pounds
With optional 6x25 IWRC rope.....	9,380 pounds.....	8,400 pounds

<p>Do not operate crane booms, jib extensions, any accessories, or loads within 10 feet (3m) of live power lines or other conductors of electricity.</p>	<p>1. Load ratings shown on the following load rating charts are maximum allowable loads with the outriggers properly extended on a firm, level surface and the crane leveled and mounted on a factory-recommended truck.</p> <p>2. Always level the crane with the level</p>	<p>indicator located on the crane frame.</p> <p>3. The operator must reduce loads to allow for factors such as wind, ground conditions, operating speeds and the effect of freely suspended loads.</p> <p>4. Overloading this crane may cause structural collapse or instability.</p>	<p>5. Weights of any accessories attached to the boom or loadline must be deducted from the load chart capacities.</p> <p>6. Do not exceed jib capacities at any reduced boom lengths.</p>
---	---	---	--

National Series 500C Load Rating Charts

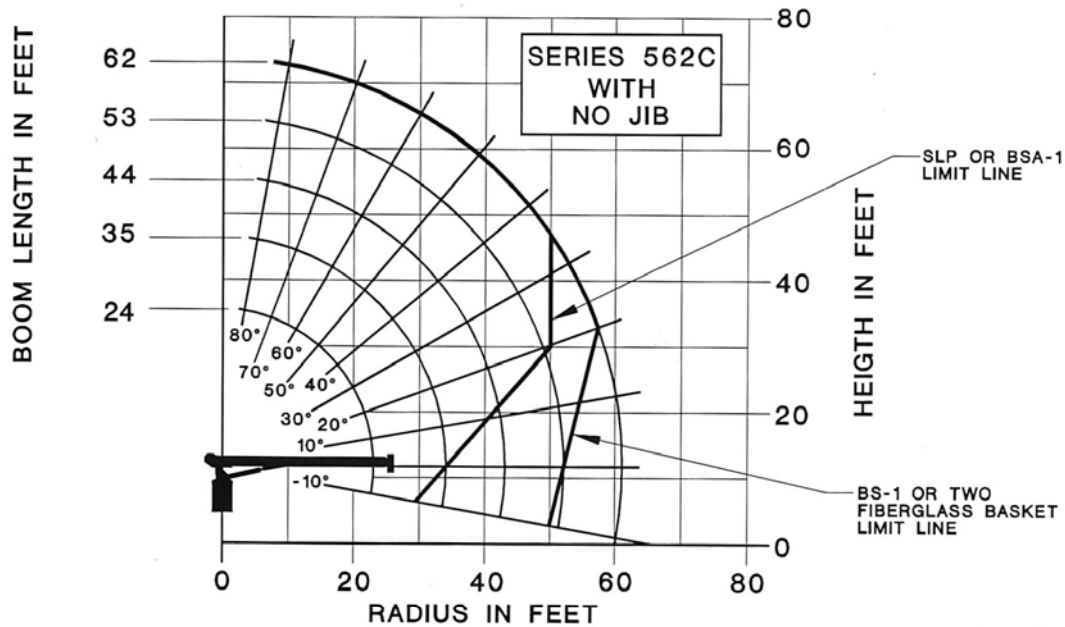

LOAD RATINGS											LOADLINE EQUIPMENT DEDUCT
LOAD RADIUS (FEET)	LOADED BOOM ANGLE	24FT BOOM (LBS)	LOADED BOOM ANGLE	35FT BOOM (LBS)	LOADED BOOM ANGLE	44FT BOOM (LBS)	LOADED BOOM ANGLE	53FT BOOM (LBS)	LOADED BOOM ANGLE	62FT BOOM (LBS)	
4.5	80	30,000									DOWNHAUL WEIGHT = 150 ONE SHEAVE BLOCK = 200 TWO SHEAVE BLOCK = 355
8	70	18,000	77.5	16,000							
10	65	15,000	73.5	13,300	77.5	12,500					
12	58.5	13,000	69.5	11,800	75	10,700	78.5	10,000			
14	53	11,300	66.5	10,300	72	9,500	76	8,800	78.5	8,400	
16	46.5	10,250	62	9,200	70	8,500	73.5	7,800	76	7,300	
20	28.5	8,450	54.5	7,700	63.5	7,000	69	6,350	72.5	6,100	
25			43	6,250	56	5,600	63.5	5,250	67	4,850	
30			29.5	4,950	47.5	4,700	56.5	4,400	62	4,200	
35					37	4,000	49.5	3,850	56.5	3,600	
40					23	3,350	42	3,350	51	3,200	
45							32	2,900	44	2,800	
50							18.5	2,400	37	2,450	
55									27	2,150	
60									13	1,650	
65											
70											
	0	5,600	0	3,200	0	2,200	0	1,500	0	1,150	

The capacities shown will be reduced when accessories are attached to the boom or loadline.

Note: Rated loads do not exceed 85% of the tipping load. Structural strength ratings in the chart above are shaded.

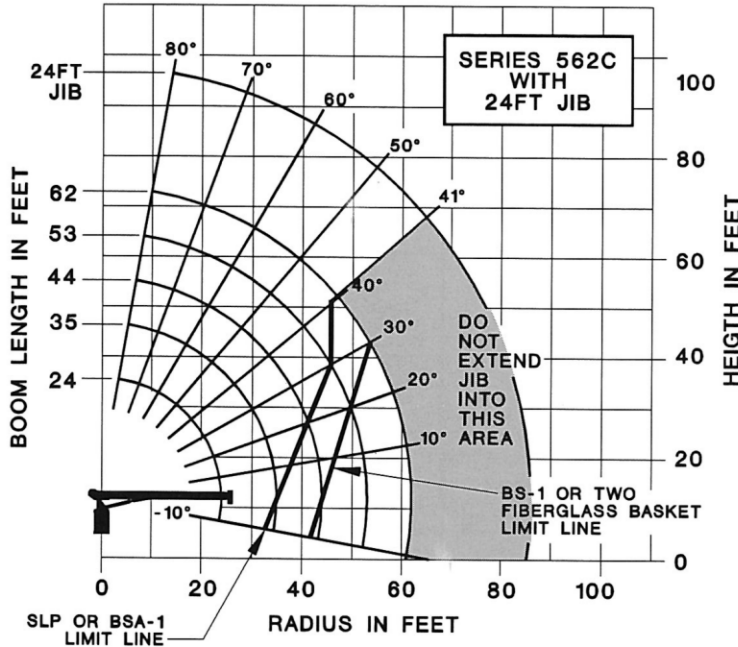

NOTE:

1. OPERATE WITH JIB BY RADIUS, WHEN MAIN BOOM IS FULLY EXTENDED. IF NECESSARY INCREASE BOOM ANGLE TO MAINTAIN LOADED RADIUS.
2. OPERATE WITH JIB BY BOOM ANGLE WHEN MAIN BOOM IS NOT FULLY EXTENDED. DO NOT EXCEED RATED JIB CAPACITIES AT ANY REDUCED BOOM LENGTHS.

JIB LOAD RATINGS		
LOAD RADIUS (FEET)	LOADED BOOM ANGLE	24FT JIB (LBS)
16	80	3,000
20	77	2,700
25	74	2,450
30	71	2,100
35	67	1,750
40	63	1,450
45	59	1,200
50	55	950
55	51	800
60	48	800
65	41	550

BOOM LOAD RATINGS											LOADLINE EQUIPMENT DEDUCT
LOAD RADIUS (FEET)	LOADED BOOM ANGLE	24FT BOOM (LBS)	LOADED BOOM ANGLE	35FT BOOM (LBS)	LOADED BOOM ANGLE	44FT BOOM (LBS)	LOADED BOOM ANGLE	53FT BOOM (LBS)	LOADED BOOM ANGLE	62FT BOOM (LBS)	
4.5	80.0	30,000									DOWNHAUL WEIGHT = 150 ONE SHEAVE BLOCK = 200 TWO SHEAVE BLOCK = 355
8	70.0	17,400	77.5	15,600							
10	65.0	14,400	73.5	12,900	77.5	12,100					
12	59.0	12,500	69.5	11,200	75.0	10,300	78.5	9,750			
14	53.0	10,800	66.5	9,900	72.0	9,400	76.0	8,500	78.5	8,100	
18	46.5	9,850	62.0	8,900	70.0	8,400	73.5	7,350	76.0	7,000	
20	29.0	8,000	54.5	7,400	63.5	6,650	69.0	6,050	72.5	5,850	
25			43.0	6,000	56.0	5,520	63.5	5,000	67.0	4,450	
30			29.5	4,700	47.5	4,350	56.5	4,200	62.0	3,900	
35					37.0	3,700	49.5	3,650	56.5	3,400	
40					23.0	3,100	42.0	3,200	51.0	3,000	
45							32.0	2,700	44.0	2,600	
50							18.5	2,200	37.0	2,250	
55									27.0	1,900	
60									13.0	1,450	
	0	5,200	0	3,000	0	2,000	0	1,300	0	900	

The capacities shown will be reduced when accessories are attached to the boom or loadline.

Note: Rated loads do not exceed 85% of the tipping load. Structural strength ratings in the chart above are shaded.

National Series 500C Load Rating Charts (continued)

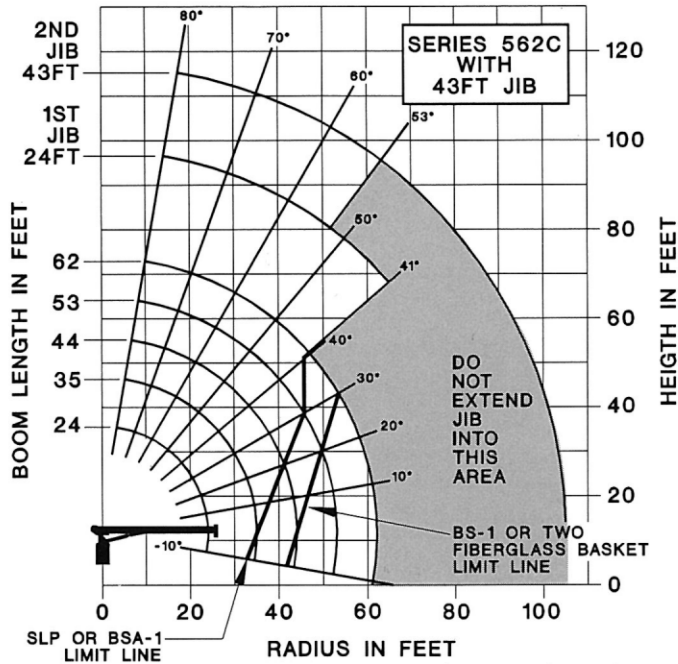

NOTE:

1. OPERATE WITH JIB BY RADIUS, WHEN MAIN BOOM IS FULLY EXTENDED. IF NECESSARY INCREASE BOOM ANGLE TO MAINTAIN LOADED RADIUS.
2. OPERATE WITH JIB BY BOOM ANGLE WHEN MAIN BOOM IS NOT FULLY EXTENDED. DO NOT EXCEED RATED JIB CAPACITIES AT ANY REDUCED BOOM LENGTHS.

JIB LOAD RATINGS				
LOAD RADIUS (FEET)	LOADED BOOM ANGLE	24FT JIB (LBS)	LOADED BOOM ANGLE	43FT JIB (LBS)
16	80	3,000		
20	77	2,700	80	2,000
25	74	2,450	78	1,850
30	71	2,100	75	1,550
35	67	1,750	72	1,350
40	63	1,450	69	1,150
45	59	1,200	66	1,000
50	55	950	63	850
55	51	800	60	700
60	48	600	58	600
65	41	550	53	550

BOOM LOAD RATINGS										LOADLINE EQUIPMENT DEDUCT
LOAD RADIUS (FEET)	LOADED BOOM ANGLE	24FT BOOM (LBS)	LOADED BOOM ANGLE	35FT BOOM (LBS)	LOADED BOOM ANGLE	44FT BOOM (LBS)	LOADED BOOM ANGLE	53FT BOOM (LBS)	LOADED BOOM ANGLE	
4.5	80.0	30,000								
8	70.0	17,400	77.5	15,600						
10	65.0	14,400	73.5	12,900	77.5	12,100				
12	59.0	12,500	69.5	11,200	75.0	10,300	78.5	9,750		
14	53.0	10,800	66.5	9,900	72.0	9,400	76.0	8,500	78.5	8,100
16	48.5	9,850	62.0	8,900	70.0	8,400	73.5	7,350	76.0	7,000
20	29.0	8,000	54.5	7,400	63.5	6,650	69.0	6,050	72.5	5,850
25			43.0	6,000	56.0	5,520	63.5	5,000	67.0	4,450
30			29.5	4,700	47.5	4,350	56.5	4,200	62.0	3,900
35					37.0	3,700	49.5	3,650	56.5	3,400
40					23.0	3,100	42.0	3,200	51.0	3,000
45							32.0	2,700	44.0	2,600
50							18.5	2,200	37.0	2,250
55									27.0	1,900
60									13.0	1,450
	0	5,200	0	3,000	0	2,000	0	1,300	0	900

DOWNHAUL WEIGHT = 150
ONE SHEAVE BLOCK = 200
TWO SHEAVE BLOCK = 355

The capacities shown will be reduced when accessories are attached to the boom or loadline.

Note: Rated loads do not exceed 85% of the tipping load. Structural strength ratings in the chart above are shaded.

National Series 500C Truck Specifications

Mounting Configurations	Configuration 1 with Torsion Box	Configuration 2 with Torsion Box	Configuration 3 with Torsion Box
<p>The versatility of the Series 500C can be enhanced by the mounting configurations described at the right. The configurations are based on the Series 500C with an 85% stability factor. The complete unit must be installed in accordance with factory requirements and a test performed to determine actual stability and counterweight requirements since individual truck chassis vary.</p>	<p>This configuration is the least expensive method for the Series 500C. This mount, with the crane mounted behind the cab, requires the least weight of all mounts for stability, thus, you can haul larger payloads on your truck. It requires standard subbase and rear (ASH) stabilizers.</p>	<p>Requires front SFO stabilizer to give machine full capacity 360° around the truck. Truck must meet the minimum requirements below. Front stabilizer gives the machine a solid base, helping the operator control loads precisely. Requires front SFOA and rear ASH stabilizers and subbase. Truck frame must be made from 110,000 PSI steel.</p>	<p>Advantages of a rear-mounted 500C: (1) allows operator to effectively use a close-in work area to lift heavier loads; and (2) 360° stability at full-rated load. Hydraulic out-and-down outriggers located behind the cab are necessary to keep the total weight of unit to a minimum with full stability. Requires front over frame outriggers, heavy-duty rear-mount subbase, air throttles and rear-mount plumbing.</p>
Stable	180°	360°	360°
Gross Axle Weight Rating (GAWR), front	12,000 lbs.	12,000 lbs.	9,000 lbs.
Gross Axle Weight Rating (GAWR), rear	21,000 lbs.	21,000 lbs.	34,000 lbs.
Wheelbase (WB)	562C: 214"	562C: 214"	222 inches
Cab to Axle/trunnion (CA/CT)	562C: 144"	562C: 144"	156 inches minimum
Frame Section Modulus (SM) under crane: 50,000 PSI, or	18.0 inch ³	35.0 inch ³	18.0 inch ³
110,000 PSI	13.3 inch ³	15.9 inch ³	13.3 inch ³
Frame Section Modulus (SM) over rear stabilizers: 50,000 PSI or	17.0 inch ³	17.0 inch ³	18.0 inch ³
110,000 PSI	13.0 inch ³	13.0 inch ³	13.3 inch ³
Stability Weight, Front	6,300 lbs. minimum*	6,300 lbs. minimum*	7,000 lbs. minimum*
Stability Weight, Rear	5,500 lbs. minimum*	8,000 lbs. minimum*	7,000 lbs. minimum*
Estimated Average Final Weight (562C)	25,900 lbs.	28,700 lbs.	29,800 lbs.
<p>Notes:</p> <ol style="list-style-type: none"> (1) GAWR means Gross Axle Weight Rating and is dependent on all components of the vehicle such as axles, tires, springs, frame, etc. meeting manufacturer's recommendations. Always specify GAWR when purchasing trucks. (2) Minimum axle requirements may increase with use of longer wheelbase, service bodies, diesel engines, or front stabilizers. (3) Diesel engines require variable speed governor and energize-to-run fuel solenoid for smooth crane operation. 			
<p>*Estimated axle scale rates prior to installation of crane, stabilizers, and subbase for 85% stability.</p>			

National Series 500C Accessories

Every Series 500C is part of the National Lifting System, a choice of accessories that add versatility to your crane. With National accessories you can tailor your crane to handle your specific job requirements. In many instances, a truck-mounted crane equipped with accessories can eliminate your need for other specialized equipment.

Because your 500C affords such versatility, you save time, money, and manpower. You can do more, faster, and with less equipment. National accessories are cost-efficient options.

Note:

Weights of all accessories attached to the boom or loadline of the crane must be deducted from the effective lifting capacity. Consult your National dealer for specific accessory availability. Some accessories cannot be used in combination with other accessories and/or certain boom/jib combinations.

Remote Control

National offers one-hand remote control for your Series 500C. Ideal where precise control and total load visibility are required.

Fine metering and instant response mean operators can position loads or work platforms easily.

National's remote controls are built with solid-state circuitry and few moving parts. They are designed for reliability. You will be impressed with the high operating speeds and modular design.



Available in two models: R4 with tilt, turn, telescope and winch functions, and R3 with tilt, turn, and telescope only. R3 is to be used to control cranes from boom-attached platforms and baskets.

A priority control valve, operated by a trigger on the remote control device, regulates oil flow and gives you fingertip speed control over all crane functions.

National's remote control is lightweight and easy to use. Consult your dealer or the factory for availability.

Model R3

Tilt, turn and telescope

Model R4

Tilt, turn, telescope and winch

Load Moment Indicator

The optional PAT DS150 load moment indicator (LMT) is a state-of-the-art load sensing system. It offers a console display of



boom length and angle, load on the hook, and available load capacity that can be lifted. These features provide the operator with a continuous reading of the crane's capacity as it moves through the motions required to make a lift. If overload capacities are approached, the LMI warns the operator by means of an audible alarm. It lights up a console warning lights and halts crane movement to prevent overload.

LMI

One Person Basket

Strong, lightweight fiberglass basket with 300-pound capacity puts personnel where you want them for tough maintenance and installation jobs. Optional dual basket brackets for two-basket operation on main boom. Easy on-off safety harness included. With basket(s) attached to the crane, the crane must be operated at a position where the crane load chart shows less than the following capacities:

- One fiberglass basket -- 550 pounds
- Two fiberglass baskets -- 1,100 pounds

Model B1

Model B1-L

With lock

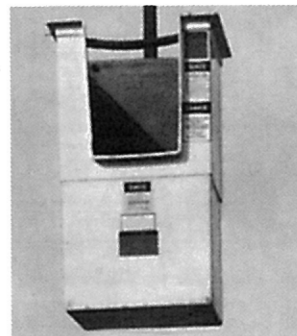

Heavy-duty Personnel Basket

New high-capacity steel personnel basket provides a rated lifting capacity of 1,200 pounds and safety loops to secure up to four passengers.* Dimensions are 72"x42"x42". Ideal for simultaneously lifting personnel, tools, and materials to above-the-ground job sites. A fast attachment system allows fast, easy pinning of basket to the boom. The gravity-leveling basket has a new, secure disc-brake locking system.

Model BSA-1

**This basket must not be used in load-rated areas where the crane load chart shows capacities less than 2,300 pounds.*



Personnel Platform

This extra strength 3x6-foot steel platform will carry up to 1,000 pounds and operate at working heights up to 87 feet. It is hydraulically self-leveling and protected by safety valves. Safety harness included. Fold down sides standard.

Optional manual rotator available for precise placement of platform. Easy-to-operate crank rotates the platform through a dependable chain drive. Continuous rotation. Locks in position.

The personnel platform must not be operated on load rated areas where the load chart shows capacities less than 2,100 pounds on Model SLP and 2,300 pounds on Model SLPR. Can be used with angling jib for additional reach.

Model SLP
Model SLPR

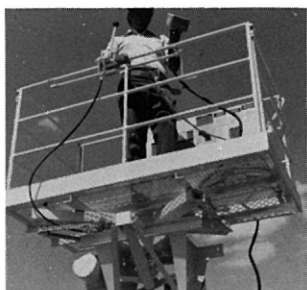

Stabilizers/Outriggers

We offer a complete range of front and rear stabilizers with hydraulic vertical and horizontal motion. All cylinders are fully enclosed for protection against dirt and damage.

Stabilizers

Vertical travel.....	20"	25.5"	25"
Ground penetration (38" frame height).....	8"	10"	13"
Operation.....	All-hydraulic	All-hydraulic	All-hydraulic
Span.....	10'	14'	Single
Controls.....	Stabilizer can be operated from either control station		

Cross-frame Outriggers

Extended span.....	15'6"
Retracted span.....	7'11"
Vertical travel	
Over-frame.....	25"
Under-frame.....	18"
Ground penetration (38" frame height)....	10"
Mounting space	
Outrigger only.....	24"

Model 5HO

Hydraulic Oil Cooler

Automatic hydraulic device designed to cool the hydraulic oil under high-cycle operation.

Model HOC

Caution

Do not operate crane booms, jib extensions, any accessories, or loads within 10 feet (3m) of live power lines or other conductors of electricity. Do not exceed jib capacities at any reduced boom lengths.

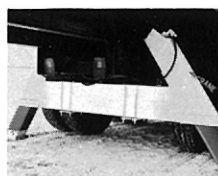

Rear Mounted
(Model ASH)



Rear Mounted
(Model RSOD)



Front Mounted*
(Model SFOA Fixed)

Pallet Fork

Turns your Series 500C into a versatile, payload-packing fork lift. Great for delivering palletized material right where you want it. 4,400-pound (1,996-kg) capacity with adjustable throat and teeth. Handles most loads with ease.

Capacity	4,400 lbs. at 20" center
Throat opening	41" to 65" (adjustable)
Tooth length	38"
Tooth width	33.5" to 57" (outside to min. max. outside)
Weight	350 lbs.

Model MKF

(Manual leveling, adjustable throat)



Loose Material Clam Bucket

Increase the flexibility of your Series 500C with a National clam bucket. Use this versatile accessory to load or move up to 2/3 cubic yard of loose material with each bite. Hooks easily to loadline, comes with hydraulic hose on automatic reel and quick-connect fittings. Extension hoses are required for use with jibs. Just position the load where you want it and open the bucket.

Model LMC

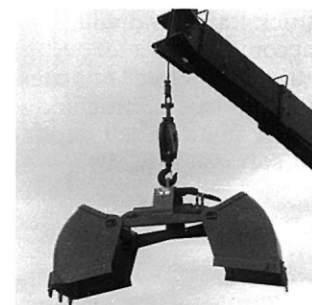

National Series 500C Specifications

General Construction:

Low-alloy, high tensile, and other steel including T-1, Ex-Ten, Stressproof and Hi-Yield are combined with special low hydrogen welding techniques wherever advantageous. Standard color: painted National Ivory.

Frame:

Box construction for maximum strength and rigidity.

Turret:

Fabricated rigid structure, well-braced for stability. Line-bored and machined after welding to ensure proper alignment.

Rotation:

375°, rotational force 239,532 in-lb. Turret rotation is by hydraulic orbit motor and planetary gearbox driving a pinion. The turret rotates on a ball-bearing race. Spring applied hydraulic release brake provides positive, no-drift lateral positioning.

Subbase:

Unitized box construction designed to increase torsional stiffness and reduce truck frame requirements. Standard subbase is designed to fit on standard 34" wide truck frame and will accommodate a 20' stringerless bed. Attaches both to truck frame and crane frame. Total depth of subbase is 8.25".

Outriggers

"A" frame box-type 19¹/₄" span (center of pad at ground level) moves out-and-down, will not bind when raising or lowering truck. Can be positioned to 9.5" below ground level on 39" truck frame height.

Tilt:

Double-acting hydraulic cylinder raises and lowers boom; butt-mounted safety holding valve prevents boom falling in event of hose failure. Heavy-duty, long-life pivot bearings.

Boom:

Boxed construction; telescopes proportionally under rated load on nylon plates impregnated with molybdenum disulfide for smooth, long-life operation. Boom cylinder and valves are easily serviced. Heavy-duty, long-life pivot bearings. "Easy Glide" wear pads reduce noisy boom "chatter" and vibration, enhance smooth and quiet operation, are easy to replace, and reduce wear and maintenance.

Winch:

Hydraulic geroller motor with planetary gear reduction brake and counterbalance valve for "power down" load lowering. 9,380 pounds bare drum single-line pull available with 235 feet of 9/16 inch, 19.25 ton breaking strength loadline. Optional "Burst-of-Speed" control increases payout and pick-up of unloaded cable 60% over normal operating speed.

Rear Stabilizer

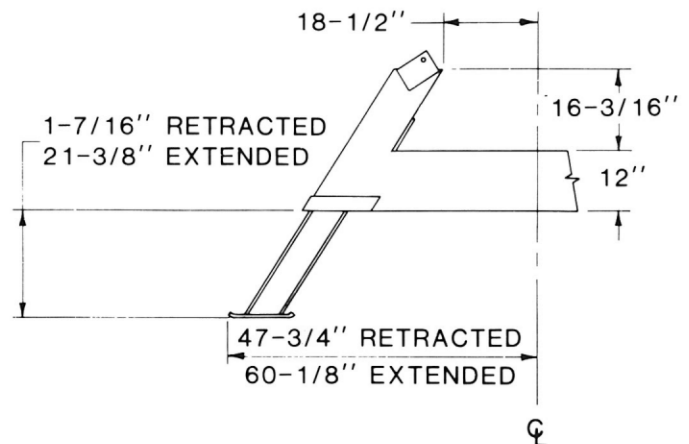

Pumps:

Tandem Vickers, high-pressure, high-speed balanced vane, replaceable cartridge-type, providing 23 gpm to crane functions and 34 gpm to winch.

Cylinders:

Shaft packing: Polyurethane cup-type. Shafts: Hi-Yield stress relieved, chrome-plated. Piston sets: Polyurethane U-cups with glass reinforced nylon bearings. Cylinder barrels: Micro-honed tubing and safety check valves.

Valves:

Four-way, spring-centered, spool-type with low spool force and extra-fine metering notches. Independent relief valves protect hydraulic circuit against overload. Relief valves are set at 2,850 psi (3,050 psi on winch system). Valves located for improved accessibility and ease of service.

Hose:

All high-pressure hose is wirebraid reinforced, having a minimum safety factor of 4 to 1.

Operating Speeds:

Winch 3rd wrap: 143 fpm. Boom up and down: 23-27 seconds. Boom out: 59 fpm. Boom in: 75 fpm. Turn: 42 seconds. When using remote control, crane function speeds will be reduced by 40% to assure smooth operation. (Speeds above assume no load with 23 gpm oil flow on boom and 34 gpm on winch).

Oil Tank Capacities:

75-gallon supply tank with breather, clean-out, suction strainers and removable magnetic plug.

Operator Console

Dual station, split front cover, indicator lights with anti-two-block and hydraulic crane alert systems, and embossed knobs.

Dimensional Specification

Series	Retracted Length	Extended Length	G	Dry* Wt/Lb	With Oil* Wt/Lb
562C	24 ft.	62 ft.	70 in	12,280*	12,930*
547C	19 ft.	47 ft.	61 in.	12,260*	12,920*
538C	16 ft.	38 ft.	52 in..	11,780*	12,430*

*Weight includes all items except ASH (800#)

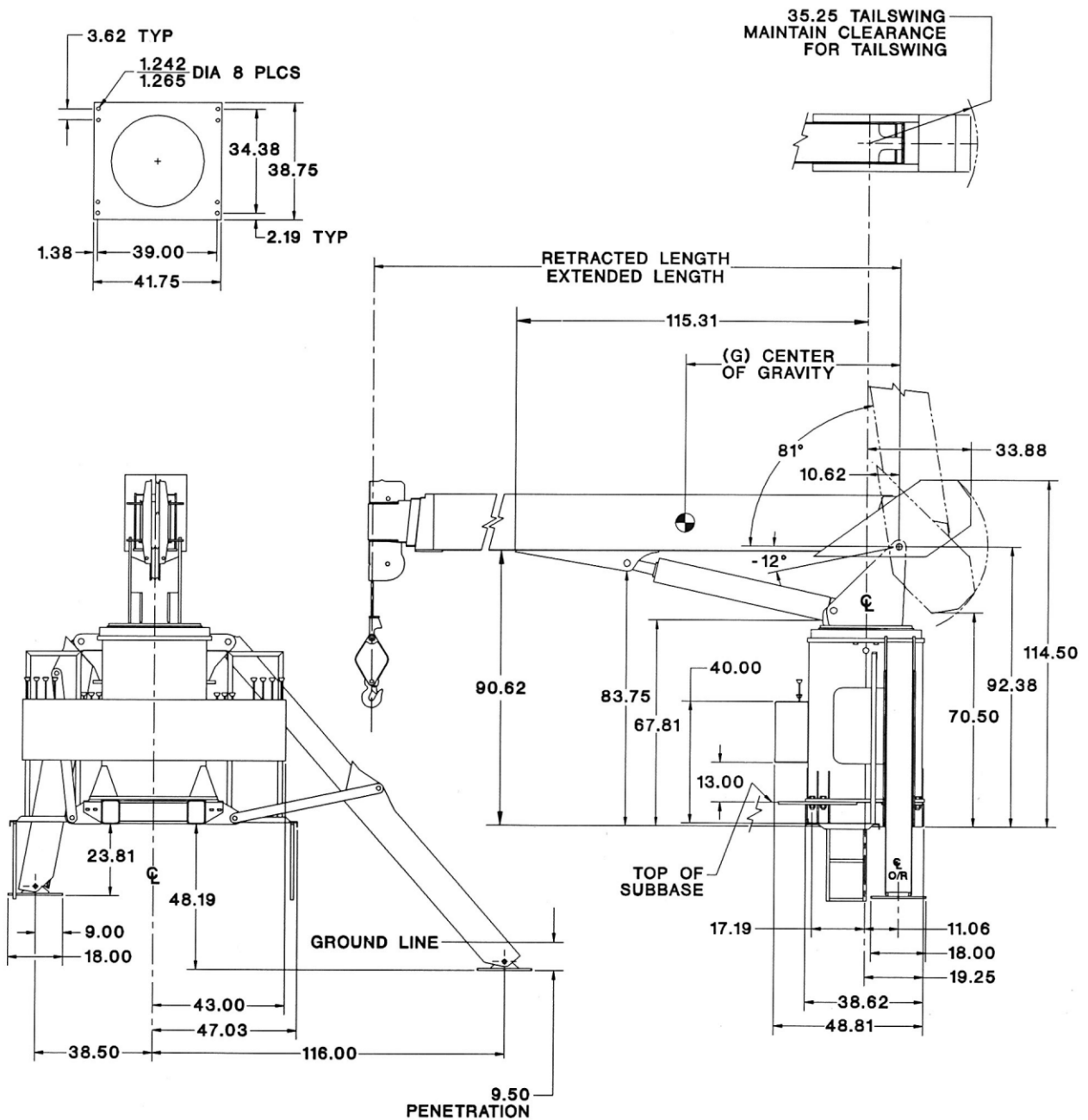

National Series 500C Proposal

<p>Date: _____</p> <p>Prepared for: _____</p> <p>_____</p> <p>Submitted by: _____</p> <p>_____</p> <p style="text-align: center;">(Firm Name)</p> <p>_____</p> <p style="text-align: center;">(Address)</p> <p>_____</p> <p style="text-align: center;">(City & State)</p> <p>_____</p> <p style="text-align: center;">(Zip)</p> <p>_____</p> <p style="text-align: center;">(Phone)</p> <p>Signed: _____</p> <p>_____</p>	<table style="width: 100%; border-collapse: collapse;"> <thead> <tr> <th style="text-align: left;">Description</th> <th style="text-align: right;">Price</th> </tr> </thead> <tbody> <tr> <td>1. Series _____</td> <td style="text-align: right;">\$ _____</td> </tr> <tr> <td>2. Boom _____</td> <td style="text-align: right;">_____</td> </tr> <tr> <td>3. Jib _____</td> <td style="text-align: right;">_____</td> </tr> <tr> <td>4. Rear Stabilizers: <input type="checkbox"/> RSOD <input type="checkbox"/> HO <input type="checkbox"/> ASH</td> <td style="text-align: right;">_____</td> </tr> <tr> <td>5. Front Stabilizers: <input type="checkbox"/> SFOA</td> <td style="text-align: right;">_____</td> </tr> <tr> <td>6. Line Block: <input type="checkbox"/> 2-3 Part <input type="checkbox"/> 4 Part <input type="checkbox"/> 5 Part <input type="checkbox"/> 6 Part</td> <td style="text-align: right;">_____</td> </tr> <tr> <td colspan="2">Accessories</td> </tr> <tr> <td>7. _____</td> <td style="text-align: right;">_____</td> </tr> <tr> <td>8. _____</td> <td style="text-align: right;">_____</td> </tr> <tr> <td>9. _____</td> <td style="text-align: right;">_____</td> </tr> <tr> <td>10. _____</td> <td style="text-align: right;">_____</td> </tr> <tr> <td colspan="2">Mounting</td> </tr> <tr> <td>11. Installation: Behind Cab <input type="checkbox"/> Std. <input type="checkbox"/> Special</td> <td style="text-align: right;">_____</td> </tr> <tr> <td>12. Installation: Rear Mounting (add to installation charge above)</td> <td style="text-align: right;">_____</td> </tr> <tr> <td><input type="checkbox"/> Air Throttle</td> <td style="text-align: right;">_____</td> </tr> <tr> <td><input type="checkbox"/> Rear Mounting Hydraulic Group</td> <td style="text-align: right;">_____</td> </tr> <tr> <td><input type="checkbox"/> Heavy-duty Rear Mount Subbase</td> <td style="text-align: right;">_____</td> </tr> <tr> <td><input type="checkbox"/> Rear Outriggers</td> <td style="text-align: right;">_____</td> </tr> <tr> <td><input type="checkbox"/> HO Outriggers</td> <td style="text-align: right;">_____</td> </tr> <tr> <td>13. Frame Reinforcement: <input type="checkbox"/> Weld <input type="checkbox"/> Bolt Extra</td> <td style="text-align: right;">_____</td> </tr> <tr> <td>14. Platform Body _____ ft. <input type="checkbox"/> Wood <input type="checkbox"/> Steel</td> <td style="text-align: right;">_____</td> </tr> <tr> <td>15. Weight in bed _____ lbs. (if required)</td> <td style="text-align: right;">_____</td> </tr> <tr> <td>16. Boom Rest: <input type="checkbox"/> Parallel <input type="checkbox"/> Low <input type="checkbox"/> Other <input type="checkbox"/> Removeable</td> <td style="text-align: right;">_____</td> </tr> <tr> <td>17. Mount SFOA</td> <td style="text-align: right;">_____</td> </tr> <tr> <td>18. Mount Stabilizers</td> <td style="text-align: right;">_____</td> </tr> <tr> <td>19. Chassis</td> <td style="text-align: right;">_____</td> </tr> <tr> <td>20. Rear Bumper Underride Protection <input type="checkbox"/> Ordered <input type="checkbox"/> Not Ordered</td> <td style="text-align: right;">_____</td> </tr> <tr> <td>21. Freight</td> <td style="text-align: right;">_____</td> </tr> <tr> <td colspan="2">This quotation will remain firm for _____ days.</td> </tr> <tr> <td>Accepted by _____</td> <td style="text-align: right;">\$ _____</td> </tr> <tr> <td style="text-align: center;">(Name)</td> <td style="text-align: right;">Total Price</td> </tr> <tr> <td style="text-align: center;">(Firm Name)</td> <td style="text-align: right;">(Date)</td> </tr> </tbody> </table>	Description	Price	1. Series _____	\$ _____	2. Boom _____	_____	3. Jib _____	_____	4. Rear Stabilizers: <input type="checkbox"/> RSOD <input type="checkbox"/> HO <input type="checkbox"/> ASH	_____	5. Front Stabilizers: <input type="checkbox"/> SFOA	_____	6. Line Block: <input type="checkbox"/> 2-3 Part <input type="checkbox"/> 4 Part <input type="checkbox"/> 5 Part <input type="checkbox"/> 6 Part	_____	Accessories		7. _____	_____	8. _____	_____	9. _____	_____	10. _____	_____	Mounting		11. Installation: Behind Cab <input type="checkbox"/> Std. <input type="checkbox"/> Special	_____	12. Installation: Rear Mounting (add to installation charge above)	_____	<input type="checkbox"/> Air Throttle	_____	<input type="checkbox"/> Rear Mounting Hydraulic Group	_____	<input type="checkbox"/> Heavy-duty Rear Mount Subbase	_____	<input type="checkbox"/> Rear Outriggers	_____	<input type="checkbox"/> HO Outriggers	_____	13. Frame Reinforcement: <input type="checkbox"/> Weld <input type="checkbox"/> Bolt Extra	_____	14. Platform Body _____ ft. <input type="checkbox"/> Wood <input type="checkbox"/> Steel	_____	15. Weight in bed _____ lbs. (if required)	_____	16. Boom Rest: <input type="checkbox"/> Parallel <input type="checkbox"/> Low <input type="checkbox"/> Other <input type="checkbox"/> Removeable	_____	17. Mount SFOA	_____	18. Mount Stabilizers	_____	19. Chassis	_____	20. Rear Bumper Underride Protection <input type="checkbox"/> Ordered <input type="checkbox"/> Not Ordered	_____	21. Freight	_____	This quotation will remain firm for _____ days.		Accepted by _____	\$ _____	(Name)	Total Price	(Firm Name)	(Date)
Description	Price																																																																		
1. Series _____	\$ _____																																																																		
2. Boom _____	_____																																																																		
3. Jib _____	_____																																																																		
4. Rear Stabilizers: <input type="checkbox"/> RSOD <input type="checkbox"/> HO <input type="checkbox"/> ASH	_____																																																																		
5. Front Stabilizers: <input type="checkbox"/> SFOA	_____																																																																		
6. Line Block: <input type="checkbox"/> 2-3 Part <input type="checkbox"/> 4 Part <input type="checkbox"/> 5 Part <input type="checkbox"/> 6 Part	_____																																																																		
Accessories																																																																			
7. _____	_____																																																																		
8. _____	_____																																																																		
9. _____	_____																																																																		
10. _____	_____																																																																		
Mounting																																																																			
11. Installation: Behind Cab <input type="checkbox"/> Std. <input type="checkbox"/> Special	_____																																																																		
12. Installation: Rear Mounting (add to installation charge above)	_____																																																																		
<input type="checkbox"/> Air Throttle	_____																																																																		
<input type="checkbox"/> Rear Mounting Hydraulic Group	_____																																																																		
<input type="checkbox"/> Heavy-duty Rear Mount Subbase	_____																																																																		
<input type="checkbox"/> Rear Outriggers	_____																																																																		
<input type="checkbox"/> HO Outriggers	_____																																																																		
13. Frame Reinforcement: <input type="checkbox"/> Weld <input type="checkbox"/> Bolt Extra	_____																																																																		
14. Platform Body _____ ft. <input type="checkbox"/> Wood <input type="checkbox"/> Steel	_____																																																																		
15. Weight in bed _____ lbs. (if required)	_____																																																																		
16. Boom Rest: <input type="checkbox"/> Parallel <input type="checkbox"/> Low <input type="checkbox"/> Other <input type="checkbox"/> Removeable	_____																																																																		
17. Mount SFOA	_____																																																																		
18. Mount Stabilizers	_____																																																																		
19. Chassis	_____																																																																		
20. Rear Bumper Underride Protection <input type="checkbox"/> Ordered <input type="checkbox"/> Not Ordered	_____																																																																		
21. Freight	_____																																																																		
This quotation will remain firm for _____ days.																																																																			
Accepted by _____	\$ _____																																																																		
(Name)	Total Price																																																																		
(Firm Name)	(Date)																																																																		



National Series 500C Telescoping Crane



 **NATIONAL CRANE**
A Grove Worldwide Company

General Offices: 11200 North 148th Street • Waverly, NE 68462
Phone: (402) 786-6300 • FAX (402) 786-6363

Your National Dealer:

National reserves the right to change designs, prices, and specifications at any time without notice.