





# SPX527CDH





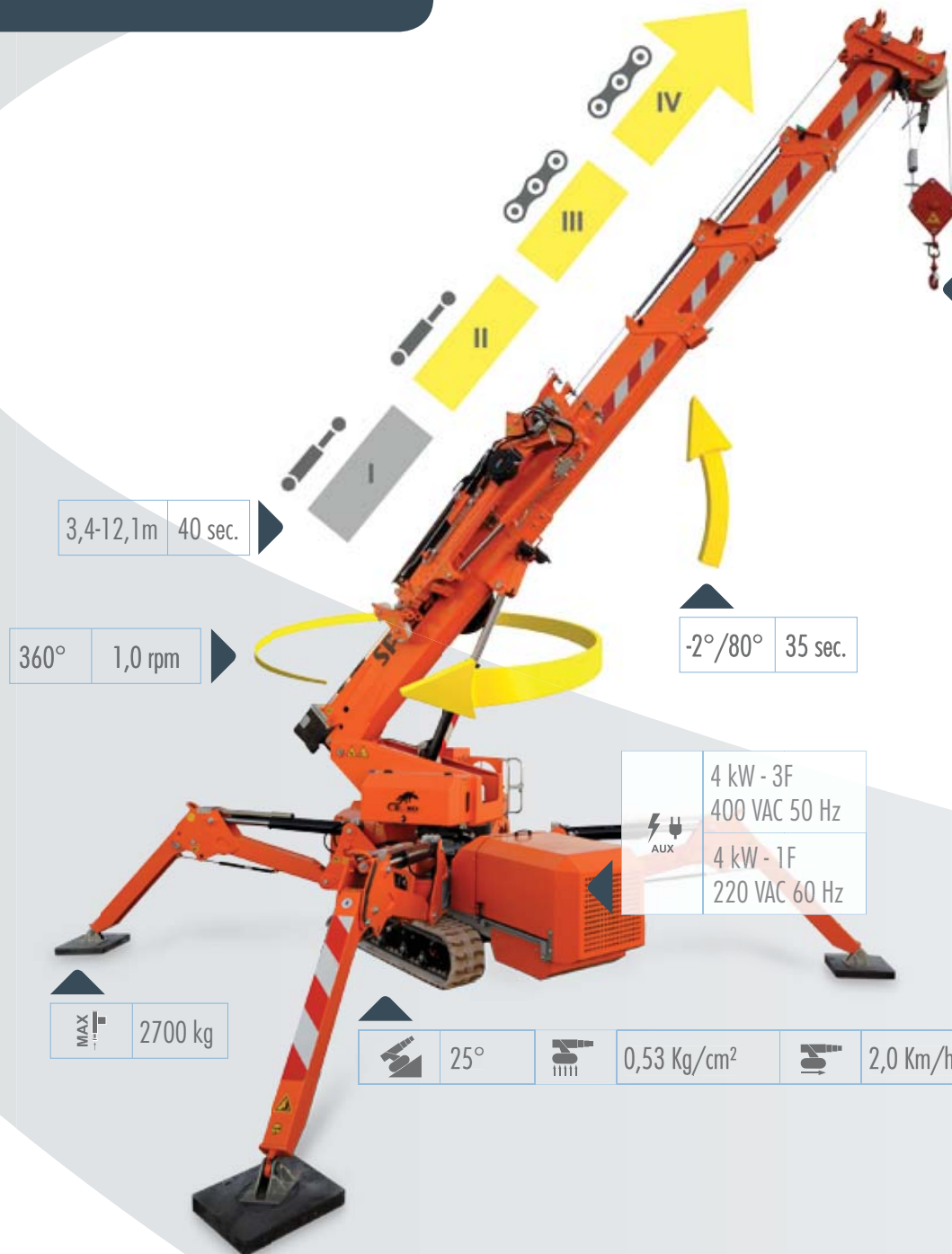

 L x W x H	4225 x 1100 x 1958 mm
	4469 x 4469 mm

		kg
 SPX527CDH		3600
 /		0
 3T-D8		30
 PP400-4D  PP220-4D		110
 JIB800G		50
 JIB600.1M		100
 JIB600.1H		220
 MR800.4		295

SPX527CDH	 ISUZU 3CB1		
	 3	<b>kW</b>	18,7kW 25,0Hp



	2700 Kg
	11,0 m
	17,5 m

	900 kg 60 m - Ø 8 mm 30 m/min
	2700 Kg 3  -20 m
	1800 Kg 2  -32 m
	800 Kg 1  -65 m

**DTC**

**LMI P&C**

**CCI VW**

**GSC 2WR**

**A2B TH**

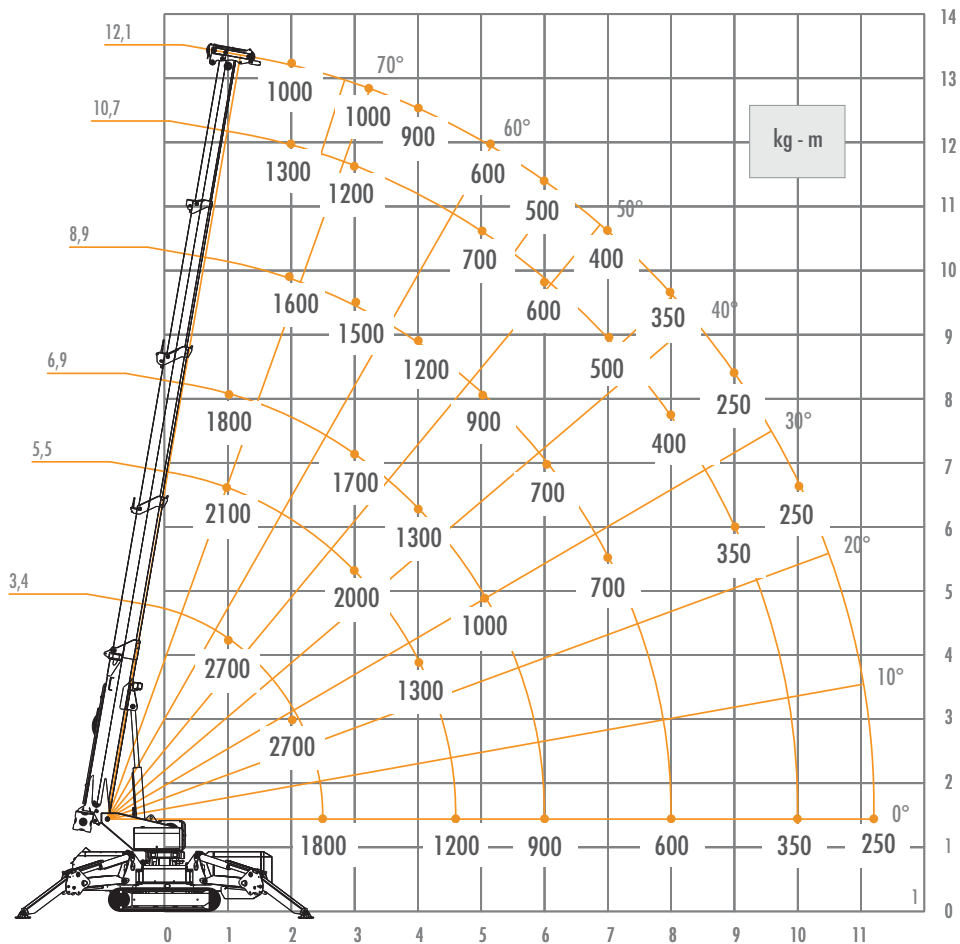

JIB800.G	JIB600.1M	JIB600.2H	MR800.4
----------	-----------	-----------	---------

<b>800 Kg</b>	<b>600 Kg</b>	<b>600 Kg</b>	<b>800 Kg</b>
<b>14,5 m</b>	<b>17,0 m</b>	<b>17,5 m</b>	<b>12,1 m</b>
<b>800 kg</b>	<b>600 kg</b>	<b>600 kg</b>	<b>500 kg</b>
<b>10,0 m</b>	<b>11,0 m</b>	<b>10,5 m</b>	<b>9,0 m</b>
<b>250 kg</b>	<b>150 kg</b>	<b>190 kg</b>	<b>250 kg</b>