

HYDRAULIC CRANE OPERATOR'S MANUAL

IMPORTANT

Read and understand this manual and CIMA User's Safety Manual before operating.

KEEP MANUALS IN CAB

COVERING CRANE MODELS

4450, 4435, 4405, 4402

Starting Machine 2 of Lot 201

Starting Machine 1 of Lot 6

Series B Models 4450, 4435, 4405, 4402

Starting Machine 4 of Lot 215

Starting Machine 5 of Lot 6

4445 Starting Machine 1 of Lot 323

4455 Starting Machine 1 of Lot 8



DIVISION OF BURRO-BADGER CORPORATION

WINONA, MINNESOTA 55987

Part Number 7605-4311

BADGER CONSTRUCTION EQUIPMENT CO.

Division of Burro-Badger Corporation

Airport Industrial Park

Winona, MN 55987

IMPORTANT SAFETY NOTICE

Safe operation depends on reliable equipment and the use of proper operating procedures. Performing the checks and services described in this manual will help to keep your crane in reliable condition and use of the recommended operating procedures can help you avoid unsafe practices. Because some procedures may be new to even the experienced operator we recommend that this manual be read, understood and followed by all who operate the crane.

Warning and caution notes have been included throughout this manual to help you avoid injury and prevent damage to the equipment. These notes are not intended to cover all eventualities; it would be impossible to anticipate and evaluate all possible applications and methods of operation for this equipment.

It is important that any procedure not specifically recommended by Badger Construction Equipment Co. be thoroughly evaluated from the standpoint of safety before it is placed in practice.

Do not modify this machine without written permission from the Badger Construction Equipment Company.

Keep this manual with the crane at all times.

NOTICE

The Badger Construction Equipment Company retains all proprietary rights to the information contained in this manual.

The company also reserves the right to change specifications without notice.

COVERED UNDER U.S. PATENTS 4038794, 3368696, 2984373, 4219121 & other patents pending.

SIDE FLY IS A REGISTERED TRADE-MARK

TABLE OF CONTENTS

IMPORTANT		OUTRIGGER OPERATION	23
SAFETY NOTICE	inside front cover	Lock Pins	23
TABLE OF CONTENTS	1	Outrigger Controls	23
INTRODUCTION	2	Extending Outriggers	23
General	2	Leveling Carrier	24
Related Manuals	2	Retracting Outriggers	24
Orientation	2	Jack Float Storage	24
Serial Number Location	2	BOOM SECTION NO. 4, SIDE FLY®	
Nomenclature	2	& JIB	25
SAFETY HIGHLIGHTS	4	Boom Section No. 4 Secured in	
OPERATOR'S CAB	5	Storage Position	25
Seat Adjustment	5	Side Fly Secured in Storage Position	26
Defroster	5	Jib Secured in Storage Position	27
Heater	5	Extending Boom Section No. 4	28
Ventilation	6	Retracting Boom Section No. 4	30
Windshield Wiper & Washer	6	Erecting Side Fly WITHOUT Jib	31
Fire Extinguisher	6	Storing Side Fly WITHOUT Jib	33
INSTRUMENT & INDICATOR		Erecting Side Fly AND Jib	35
IDENTIFICATION	7	Storing Side Fly AND Jib	42
CONTROL IDENTIFICATION	8	REEVING	46
CHECKS & SERVICES		General	46
BEFORE STARTING ENGINE	10	Wire Rope Specifications	46
ENGINE OPERATION	12	Reeving Hook Block	46
Starting the Engine	12	Installing Wedge Sockets	47
Normal Engine Operation	13	CRANE OPERATION	47
Stopping the Engine	13	General	47
WARM UP &		Load Monitor	47
OPERATIONAL CHECKS	14	Boom Angle Indicator	47
CARRIER OPERATION	15	Calculating Boom Length	48
Brake System	15	Areas of Operation Diagrams	48
Service Brakes	15	Range Diagram	49
Parking Brakes	15	Load Rating Chart	49
Emergency Brakes	16	Planning a Lift	51
Reserve Air Pressure	16	Swing	51
Steering System	17	House Lock	51
General	17	Swing Lock	52
Steering Controls & Indicator	17	Swing Brake	52
Front Wheel Steering	17	Swing Right & Left	52
Rear Wheel Steering	17	Boom Hoist	53
Steering While Traveling Forward	18	Normal Hoisting & Lowering	53
Steering While Traveling Rearward	19	Boom Hoist Speed-Up	53
Rear Axle Oscillation	20	Telescoping Boom	53
General	20	Main Winch	54
Normal Oscillation	20	Two Speed Winch	54
Oscillation Lock	20	Controlled Free Fall	55
Oscillation Lock Override	20	Auxiliary Winch	55
Drive Train	21	Drum Rotation Indicator	55
Torque Converter	21	Anti-Two Block System	56
Transmission	21	LUBRICATION	58
Two & Four Wheel Drive	21	Lubrication & Maintenance Diagram	58
Parking	22	Lubrication & Maintenance Schedule	59
Parking Procedure	22	Recommended Lubricants	60
Towing	22	Capacities	60
		Replacement Filter Elements	60
		HAND SIGNALS	inside back cover

INTRODUCTION

General

This manual provides important information to familiarize you with safe operating and maintenance procedures for the Self-Propelled Hydraulic Crane. Even though you may be familiar with similar equipment, **you MUST read and understand this manual before operating the unit.**

If you have any questions regarding the crane, contact your authorized Warner & Swasey Distributor. He is thoroughly familiar with the entire unit and will be happy to help you.

Because many control interlocks have been provided to increase the safety and efficiency of this crane it is important that the operator read and thoroughly understand this manual before operating.

Related Manuals

Separate publications are furnished with the crane to provide information concerning safety, replacement parts, maintenance procedures, theory of operation and vendor components. **You MUST**

read and understand CIMA Crane User's Safety Manual before operating the unit.

Orientation

When used to describe the location of components in the upperstructure, the directions front, rear, right and left relate to the orientation of a man sitting in the operator's seat. In relation to the carrier, front, rear, right and left are determined by the engine; the engine is at the rear of the carrier; right and left relate to the orientation of a man standing behind the carrier and looking forward.

Serial Number Location

The serial number plate is located beneath the cab door. Specify serial number and lot number when ordering parts and when discussing specific applications and procedures with your distributor.

Nomenclature

Nomenclature used in this manual is shown in the following illustration.

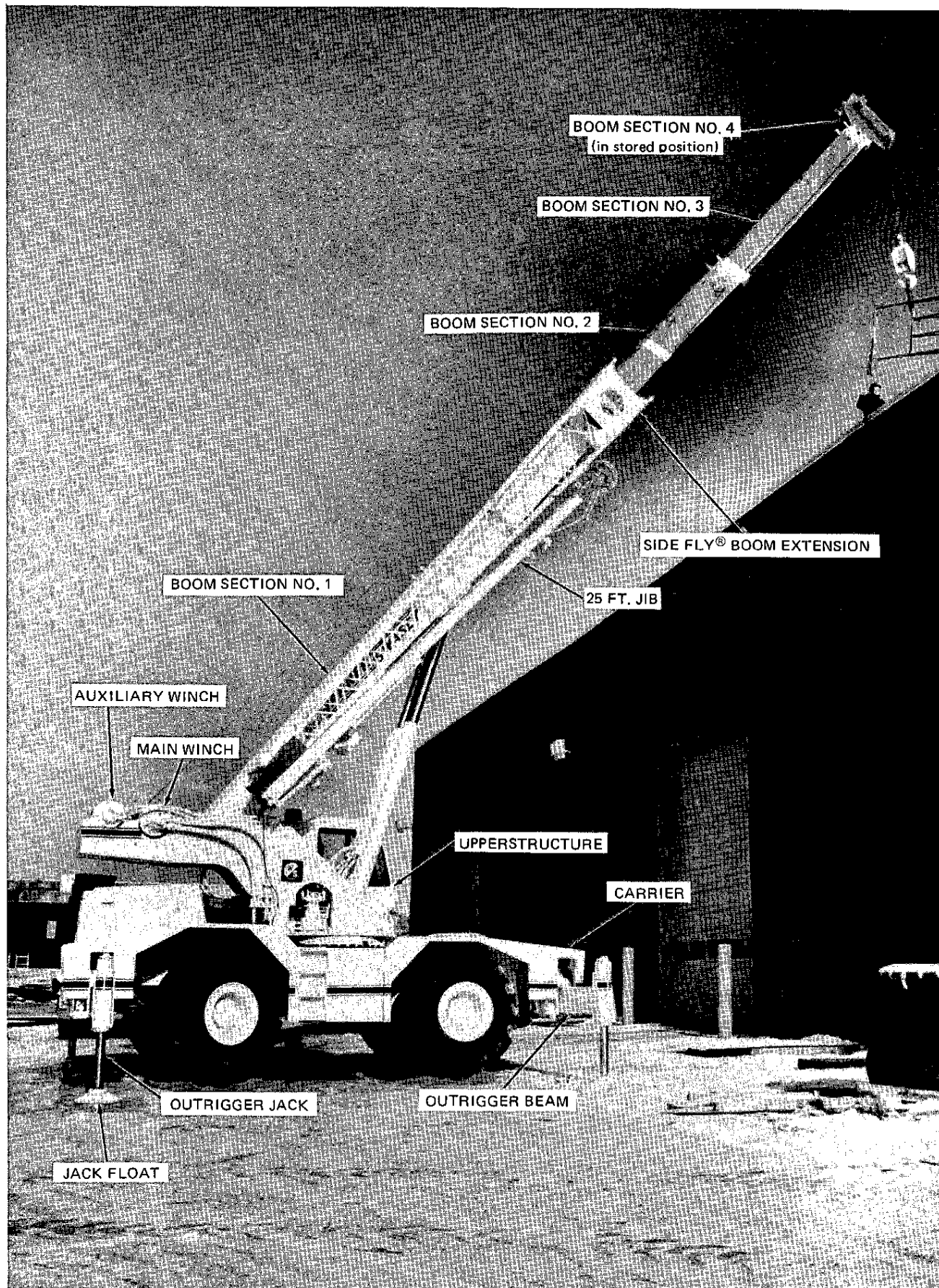

NOMENCLATURE APPLIED TO CRANE COMPONENTS

SAFETY HIGHLIGHTS

Read and understand this manual, local safety laws, codes and regulations and separate CIMA CRANE User's Safety Manual before operating. Serious injury or death can result from unsafe operating practices.



Inspect your crane daily. At the beginning of each shift, perform all CHECKS AND SERVICES listed under BEFORE STARTING ENGINE and WARM UP & OPERATIONAL CHECKS. Complete all required maintenance before operating the crane.

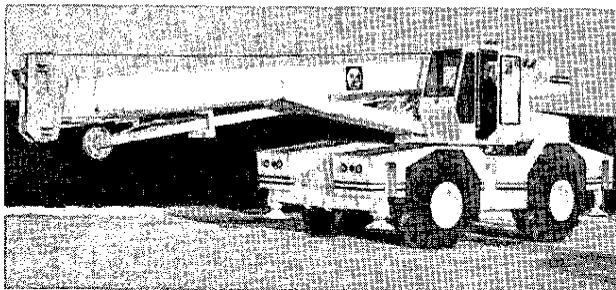
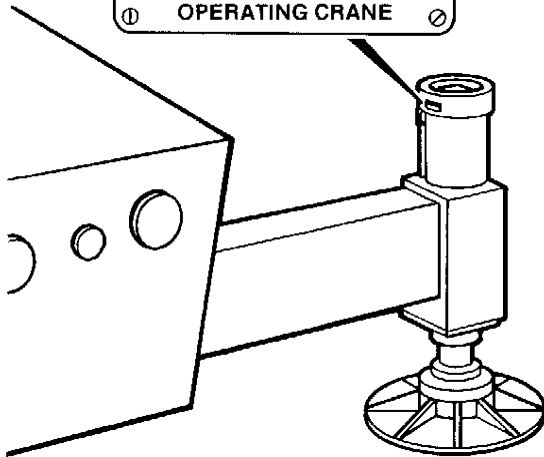

Travel only with crane in travel position (front of upperstructure aligned with front of carrier, house lock engaged, jib and side fly stored and boom fully retracted and lowered).

WARNING

If boom length exceeds 64 feet (including Side Fly and jib if erected) driving the carrier is hazardous and is not recommended. Driving the unit with excessive boom erected may cause the crane to tip over. If the crane must be driven in an emergency, all of the following conditions must be met:

- Boom must be retracted as far as possible
- Operator must be thoroughly experienced
- Crane must not be under load
- Crane must be facing front with house lock engaged
- Travel surface must be firm, smooth and level
- Tires must be properly inflated
- Outrigger beams must be fully extended and jack floats must be lowered to within 2 or 3 inches of the ground
- A man must be stationed at each side of carrier to observe jack float clearance
- Travel speed must not exceed 1 MPH



Keep everyone off the crane while it is operating. Be alert for those who may be working near the crane.

USE LOAD RATING CHART TO ASSURE SAFETY OF EVERY LIFT.

OPERATOR'S CAB

Seat Adjustment

The operator's seat includes adjustments for height, seat angle, seat back angle and fore and aft positioning.

Always fasten seat belt before operating.

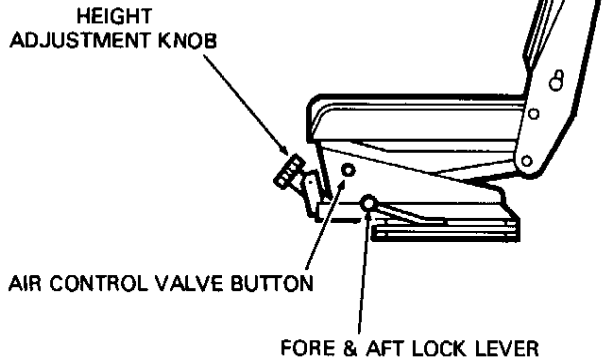

Adjust height by turning height adjustment knob clockwise to raise seat or counterclockwise to lower seat. Seat may be raised 2" from fully lowered position.

Adjust seat angle by pressing air control valve button to tilt seat forward and pulling button to tilt seat to the rear. Brake system must be pressurized to operate this adjustment.

Adjust seat back angle by lifting seat back and then lowering it into one of the three preset positions.

Adjust fore and aft positioning by lifting fore and aft lock lever and sliding seat to desired position. Release lever to lock seat in position.

Defroster

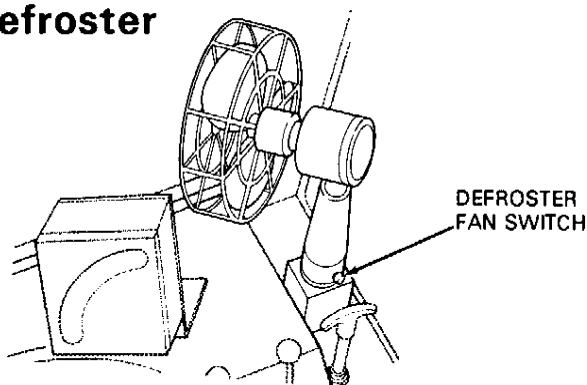

A defroster fan is located at the right side of the control console and may be pivoted to direct air flow as desired. A variable speed control switch is provided on fan pedestal to control air flow.

Heater

The heater is a propane burning, thermostatically controlled heating device. Use propane ONLY from a container designed for VAPOR TAKE-OFF.

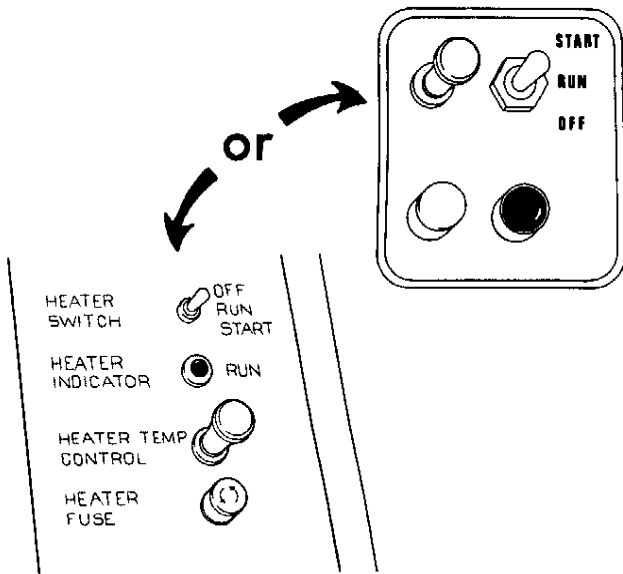

WARNING

Be sure heater exhaust gasses are piped to the outside if heater is to be operated in an enclosed area. Exhaust contains carbon monoxide, an odorless, colorless and poisonous gas.

To start the heater perform the following procedure:

1. Adjust HEATER TEMP control knob to the approximate heat setting desired.
2. Move HEATER SWITCH to START position and hold for 30 to 45 seconds before releasing. HEATER INDICATOR light should glow with switch in START position.
3. After being released, switch will move to RUN position and HEATER INDICATOR light should continue to glow. If light does not continue to glow, repeat step 2.
4. If indicator light still goes out, adjust TEMPERATURE control knob to a slightly higher heat setting and repeat step 2.

CONTINUED . . .

To stop heater, move HEATER SWITCH to OFF position. **With switch in OFF position, heater fan will continue to run until heater cools to a preset point and then turn off automatically.** This prevents an accumulation of raw fuel within the heater.

Ventilation

Varying degrees of cab ventilation can be attained by opening the door, the rear window, the skylight window and by removing the front window.

Door

The cab door must be kept in the fully opened or fully closed position or it will be free to slide. When moved to either position, the latch will lock into the door frame and hold the door in position.

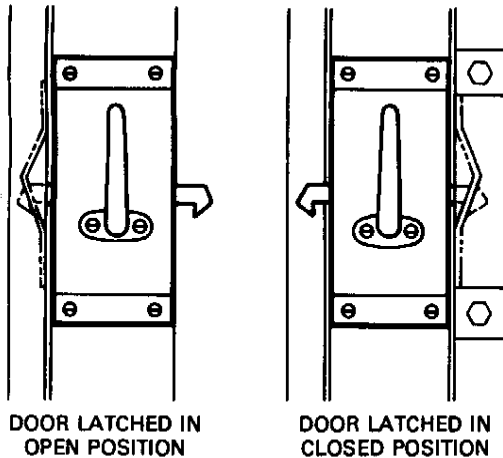

The latch can be released by moving the door handle in the direction the door is to be moved. **Check to be sure the door is securely latched in the desired position before beginning operation.**

Front Window

WARNING
To avoid accidental actuation of controls, always stop engine before removing or installing front window. Do not remove window with load suspended.

To remove the front window, turn the latch knobs to unlock the window and carefully lift the window from its support channel. Store window in the rack provided on engine cowl and secure in position using window latches.

Rear & Skylight Windows

To open the rear window or the skylight window, turn the latch knobs to unlock the window. Open the window and position both throwout arm pins in the appropriate notches. Tighten locking knobs to hold window in the desired position.

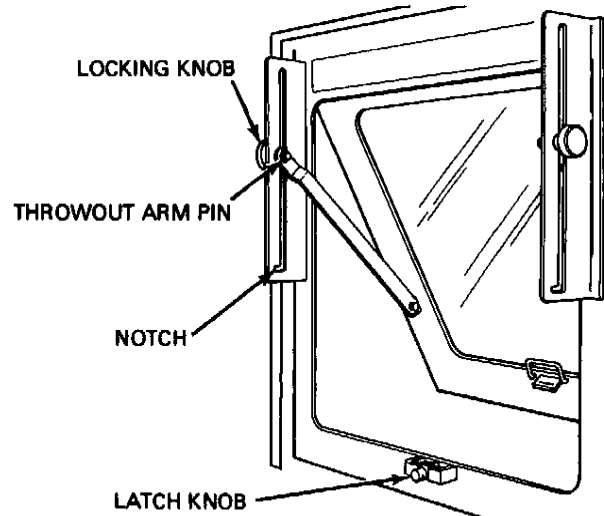

After closing the rear or skylight window, be sure to secure it by tightening latch knobs.

Windshield Wiper and Washer

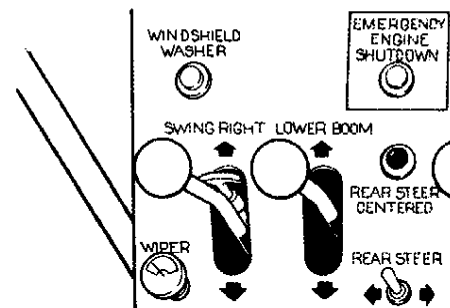

The windshield wiper is controlled by a two speed switch at the lower left corner of the control console and the windshield washer is controlled by a pushbutton just above the wiper switch. When depressed, the button causes a steady stream of windshield washer fluid to flow onto the front window.

Fire Extinguisher

A fire extinguisher is located on the left side of the operator's seat riser. **Read and understand the instructions** printed on the extinguisher regarding its care and operation. **Check periodically to be sure extinguisher is fully charged.**

INSTRUMENT AND INDICATOR IDENTIFICATION

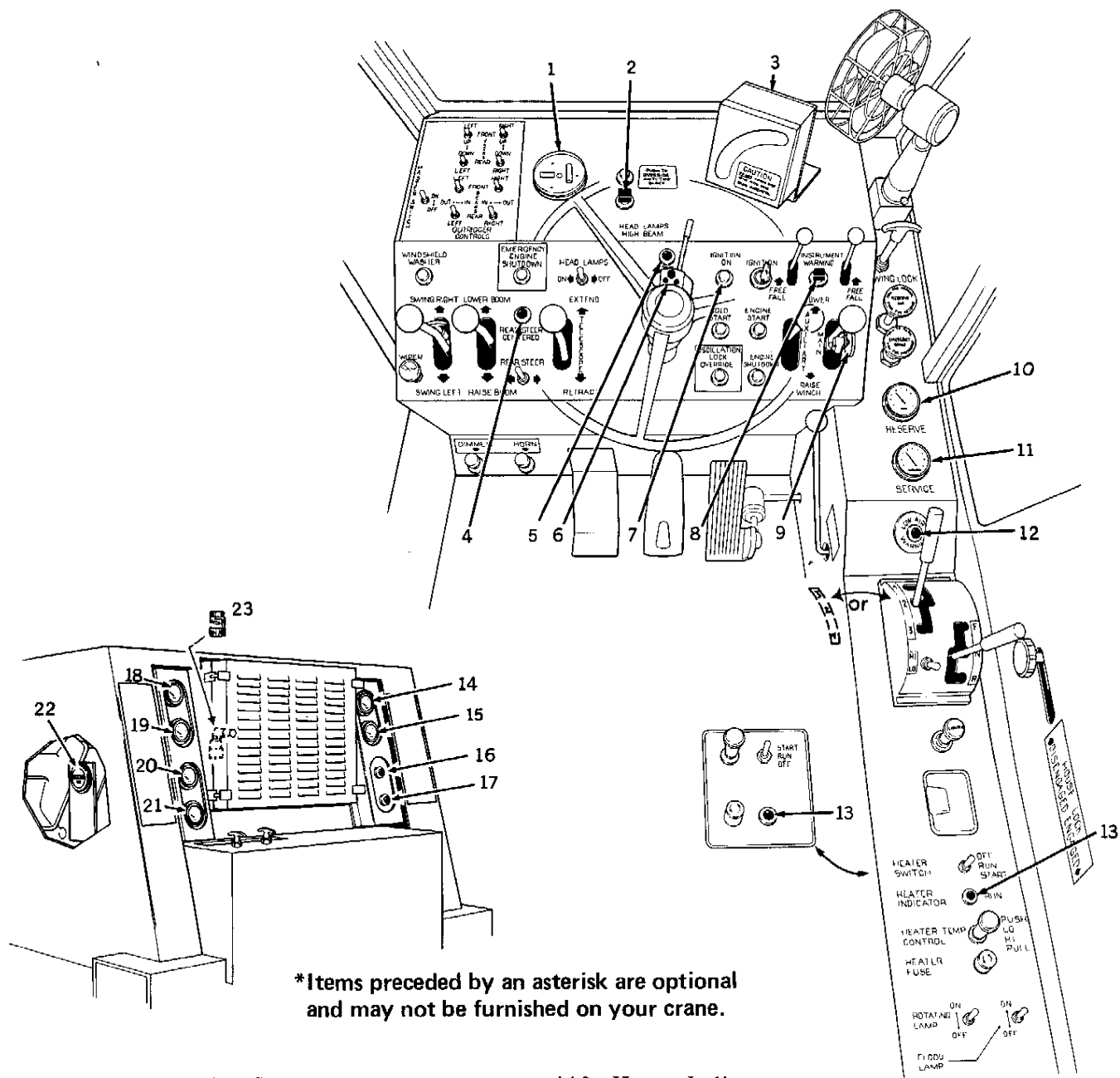

***Items preceded by an asterisk are optional and may not be furnished on your crane.**

- | | |
|-------------------------------------|---|
| 1. Carrier Leveling Indicator | *13. Heater Indicator |
| *2. Anti-Two Block Warning Light | 14. Torque Converter Oil Temperature Gage |
| 3. Boom Angle Indicator | 15. Torque Converter Oil Pressure Gage |
| 4. Rear Steering Centered Indicator | 16. Hydraulic Filter Condition Indicator |
| 5. High/Low Beam Indicator | 17. Hydraulic Filter Condition Indicator |
| 6. Directional Signal Indicator | 18. Voltmeter |
| 7. Ignition On Indicator | 19. Engine Oil Pressure Gage |
| 8. Instrument Warning Indicator | 20. Engine Coolant Temperature Gage |
| 9. Drum Rotation Indicator | 21. Fuel Level Gage |
| 10. Reserve Air Pressure Gage | 22. Engine Hourmeter |
| 11. Service Air Pressure Gage | 23. Air Cleaner Condition Indicator |
| 12. Low Air Indicator | |

INSTRUMENT AND INDICATOR IDENTIFICATION

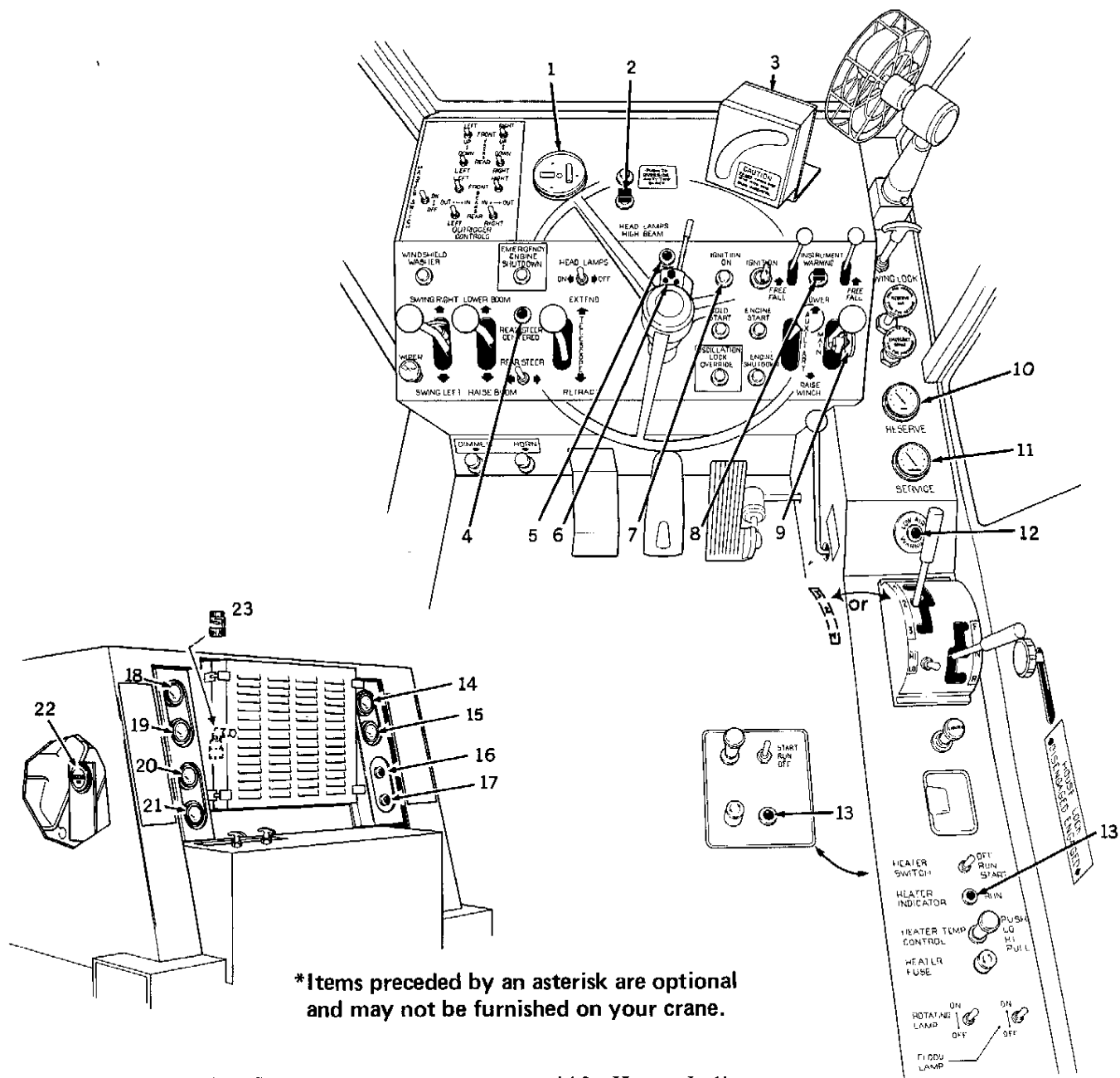

*Items preceded by an asterisk are optional and may not be furnished on your crane.

- | | |
|-------------------------------------|---|
| 1. Carrier Leveling Indicator | *13. Heater Indicator |
| *2. Anti-Two Block Warning Light | 14. Torque Converter Oil Temperature Gage |
| 3. Boom Angle Indicator | 15. Torque Converter Oil Pressure Gage |
| 4. Rear Steering Centered Indicator | 16. Hydraulic Filter Condition Indicator |
| 5. High/Low Beam Indicator | 17. Hydraulic Filter Condition Indicator |
| 6. Directional Signal Indicator | 18. Voltmeter |
| 7. Ignition On Indicator | 19. Engine Oil Pressure Gage |
| 8. Instrument Warning Indicator | 20. Engine Coolant Temperature Gage |
| 9. Drum Rotation Indicator | 21. Fuel Level Gage |
| 10. Reserve Air Pressure Gage | 22. Engine Hourmeter |
| 11. Service Air Pressure Gage | 23. Air Cleaner Condition Indicator |
| 12. Low Air Indicator | |

CONTROL IDENTIFICATION

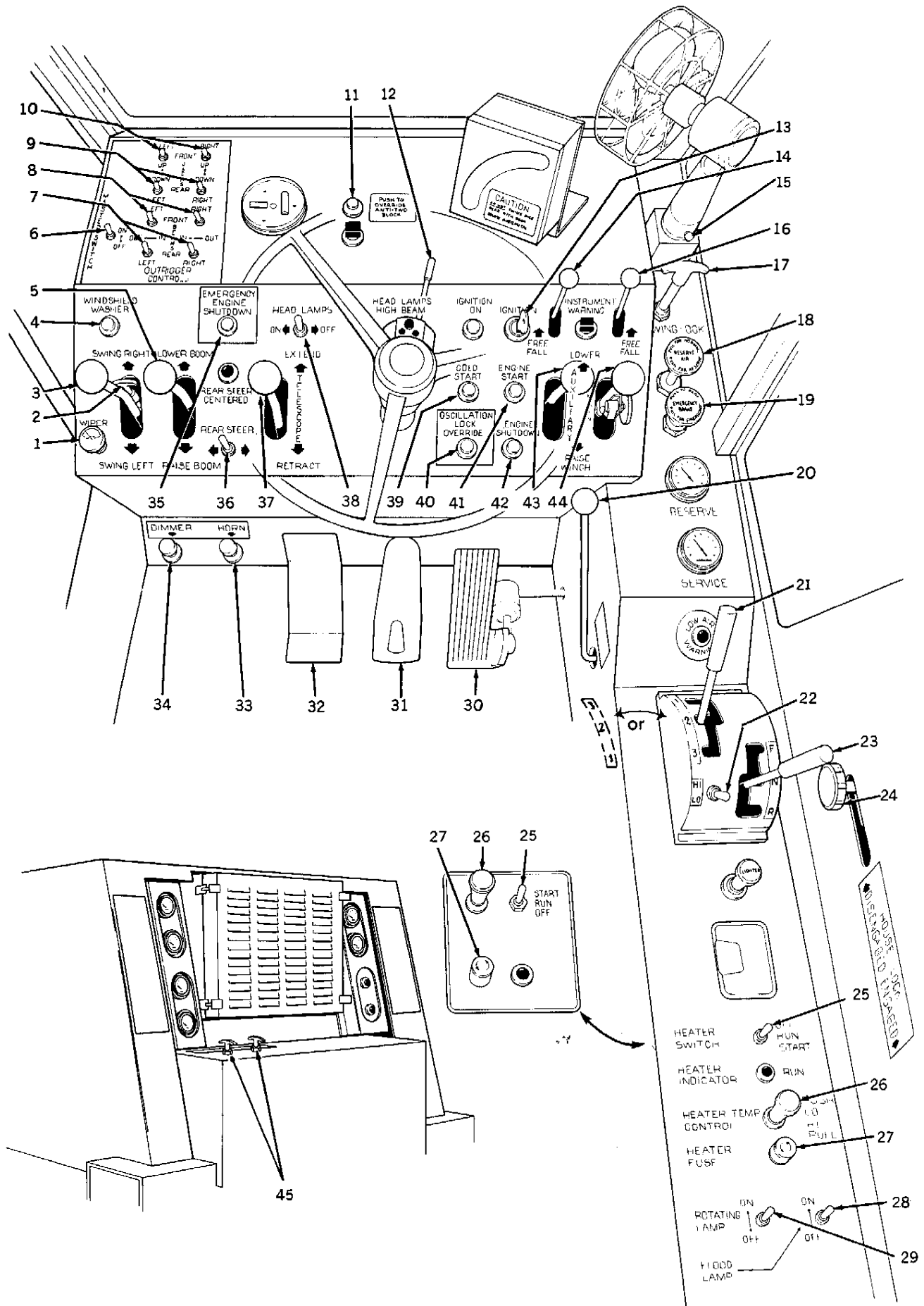

- | | |
|--------------------------------------|--|
| 1. Windshield Wiper Switch | 24. House Lock Lever |
| 2. Swing Brake Handle | *25. Heater Switch |
| 3. Swing Lever | *26. Heater Temperature Knob |
| 4. Windshield Washer Pushbutton | *27. Heater Circuit Fuse (10 amp) |
| 5. Boom Lever | *28. Flood Lamp Switch |
| 6. Outrigger & Jack Master Switch | *29. Rotating Lamp Switch |
| 7. Rear Outrigger Switches | 30. Engine Throttle Pedal |
| 8. Front Outrigger Switches | 31. Brake Pedal |
| 9. Rear Jack Switches | 32. Boom Pedal |
| 10. Front Jack Switches | 33. Horn Switch |
| *11. Anti-Two Block Override Switch | 34. Headlight High/Low Beam Switch |
| 12. Directional Signal Lever | 35. Emergency Shutdown Pushbutton
(for Detroit Diesel only) |
| 13. Ignition Switch | 36. Rear Wheel Steering Toggle |
| *14. Auxiliary Winch Free Fall Lever | 37. Boom Telescope Lever |
| 15. Defroster Fan Switch | 38. Head Lamp Switch |
| *16. Main Winch Free Fall Lever | 39. Cold Start Pushbutton |
| 17. Swing Lock Handle | 40. Oscillation Lock Override Pushbutton |
| 18. Reserve Air Knob | 41. Engine Start Pushbutton |
| 19. Emergency Brake Knob | 42. Engine Shutdown Pushbutton
(for Detroit Diesel only) |
| *20. Main Winch Speed Control Lever | *43. Auxiliary Winch Lever |
| 21. Transmission Shift Lever | 44. Main Winch Lever |
| 22. Transmission Range Shift Toggle | 45. Pump Disconnect Handles |
| 23. Forward & Reverse Shift Lever | |

***Items preceded by an asterisk are optional
and may not be furnished on your crane.**

CHECKS AND SERVICES BEFORE STARTING ENGINE

(To be performed at beginning of each work shift)

Complete all required maintenance before operating crane.

WARNING

Use extreme caution when checking items beyond your normal reach. Use an approved safety ladder.

allowed to enter these ports, it can shorten the life of o-rings, seals, packings and bearings.

When adding fluids or changing filter elements, refer to the lubrication section of this manual to determine the proper type to be used.

Before removing filler caps or fill plugs, wipe all dirt and grease away from the ports. If dirt is

If spark arrestors are used, be sure they are in place and in good working order.

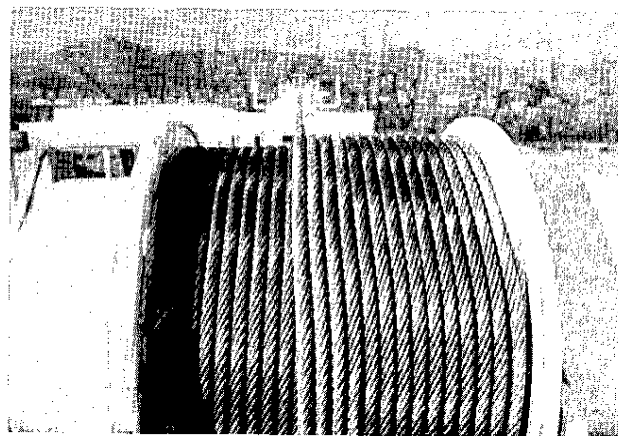

Inspect crane for obvious damage, vandalism and needed maintenance. Check for signs of fuel, lubricant, coolant and hydraulic leaks. Open all access doors and look for loose fittings, clamps, components and attaching hardware. Replace hydraulic lines that are cracked, brittle, cut or show signs of abrasion.

Check wire rope for kinks, broken strands, excessive wear and any other damage. Be sure wire rope is wound on winch drums properly and that all rope fittings and keepers are secure.

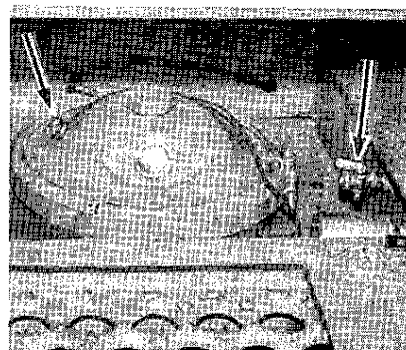
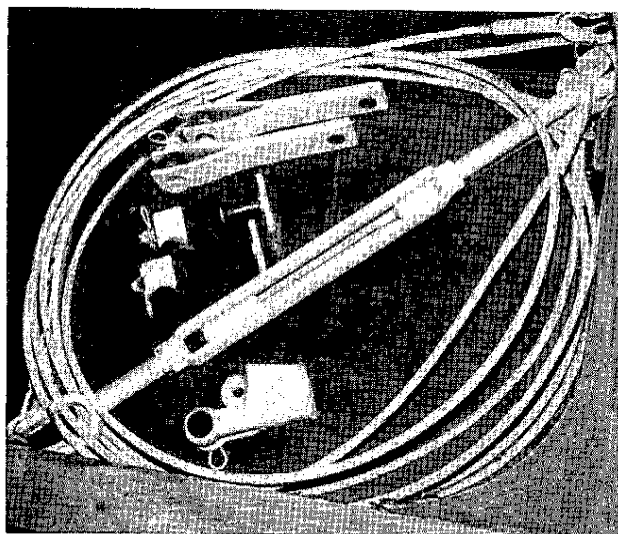

Check for secure stowage of Side Fly boom extension, jib and all tools and equipment.

With machine level, all cylinders fully retracted and engine stopped, open vent petcocks on hydraulic reservoir and hydraulic filter cover. **Check hydraulic fluid level** in sight gages and replenish as necessary. Be sure to replace filler cap and close vent petcocks.

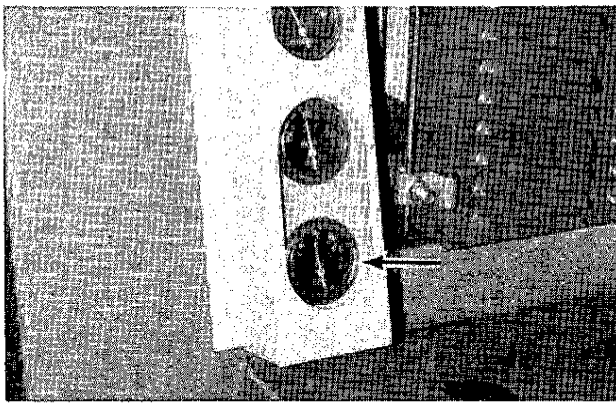

Check fuel level and replenish as necessary. It is recommended that the crane be refueled at the end of the work shift to minimize condensation.

WARNING

Stop engine while refueling the crane. Be sure the area is free of open flame, sparks or any condition which could cause fuel to ignite.

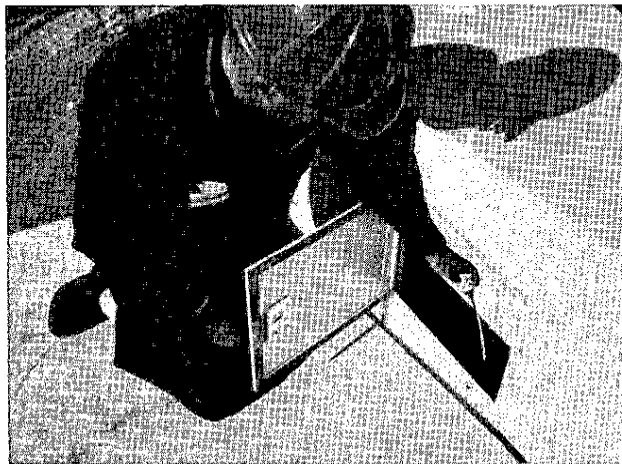

Check oil level in engine crankcase and replenish as necessary. **DO NOT OVERFILL.**

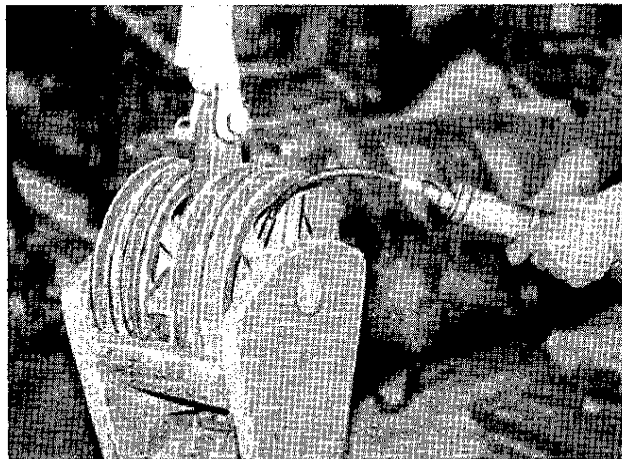

Service the crane in accordance with lubrication and maintenance schedule.

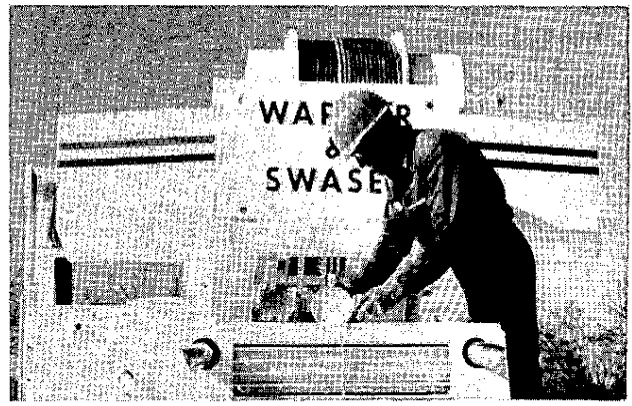

Check engine coolant level and replenish as necessary. Be sure anti-freeze solution is adequate for expected temperatures. Be sure radiator fins are clean.

WARNING

If it is necessary to check the coolant level in a hot radiator, shut off the engine and relieve pressure before removing the radiator cap. Relieve pressure by holding the cap with rags and turning to the left and waiting a few minutes until the sound of escaping pressure stops. Then remove cap cautiously.

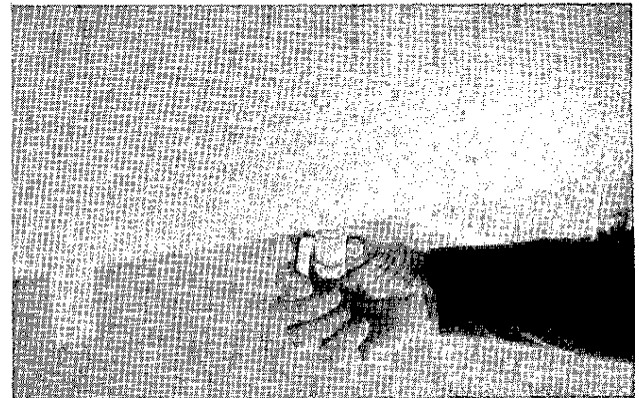

Check to be sure **drain cocks** on brake system air reservoirs **are closed.**



Check for presence of fully charged fire extinguisher.

ENGINE OPERATION

NOTE: If engine is being started at beginning of work shift be sure to perform all "CHECKS AND SERVICES BEFORE STARTING ENGINE" (pages 10 and 11).

Starting the Engine

1. If engine is being started in cold weather, tandem pumps may be disconnected to reduce starting load. Disconnect pumps by lifting PUMP DISCONNECT handles and twisting them to locked position. **Always disconnect tandem pumps before moving to and from job sites.**

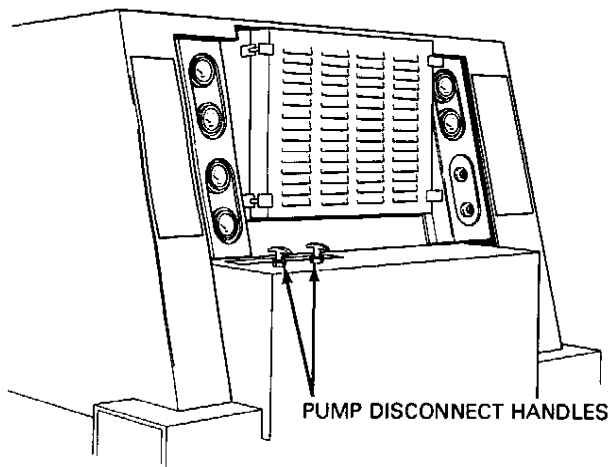

CAUTION

Engine must be stopped when disconnecting or connecting pumps or serious damage can occur.

2. Insert ignition key and turn clockwise to ON position. IGNITION ON indicator light should glow and continue to glow while engine is running.

Turning ignition on will also cause INSTRUMENT WARNING light to glow until engine is started to indicate that light functions. The INSTRUMENT WARNING light should go out when engine starts.

CAUTION

Depressing ENGINE START button while engine flywheel is rotating can cause serious damage to engine and/or starter motor.

3. Depress accelerator pedal to approximately 1/3 throttle position and depress ENGINE START button. Release button immediately when

engine starts. If engine fails to start within 30 seconds, release button and allow starting motor to cool for a few minutes before trying again.

NOTE: Your engine may be equipped with an optional ether starting aid to facilitate cold weather starting. When low temperatures cause hard starting depress ENGINE START button (step 3) and then depress COLD START button to inject ether into engine. **Release COLD START button after 3 seconds** while continuing to hold ENGINE START button. If engine does not start within 5 seconds, repeat 3 second ether injection while engine is cranking.

CAUTION

Depress COLD START button only while engine is cranking. Injecting ether before cranking engine can cause serious damage.

4. After engine starts, observe INSTRUMENT WARNING light. If light continues to glow for more than ten seconds after engine starts, **stop engine immediately and determine cause.** When light glows while engine is running, it indicates low engine oil pressure, high engine coolant temperature or high torque converter oil temperature. Correct cause of malfunction before starting engine.
5. When INSTRUMENT WARNING light goes out, observe gage clusters at front of engine compartment to be sure all systems are functioning properly.
6. If pumps were disconnected to facilitate starting, **stop engine** and connect pumps by twisting disconnect handles to unlocked position and releasing. Engine may be started again after connecting pumps.
7. Warm up engine until water temperature reaches minimum operating range: 170° F. for Cummins and 160° F. for Detroit Diesel.

Normal Engine Operation

Observe gages frequently to be sure all engine systems are functioning properly.

Oil Pressure:

Detroit Diesel Engine	40 to 60 psi
Cummins Engine	45 to 70 psi
Torque Converter	180 to 220 psi

Engine Coolant Temperature:

Detroit Diesel	160 to 185° F.
Cummins	170 to 185° F.

Torque Converter Oil Temperature 180 to 200° F.

Service Air Pressure 60 to 140 psi

Reserve Air Pressure 60 to 140 psi

Be alert for unusual noises or vibration. When an unusual condition is noticed, stop machine in a safe position and shut off engine. Determine cause and correct problem before continuing.

Early recognition and correction of unusual conditions can often prevent a major breakdown.

Avoid prolonged idling. Idling causes engine temperature to drop and this permits formation of heavy carbon deposits and dilution of lubricating oil by incompletely burned fuel. If the engine is not being used, turn it off.

CAUTION

Operate Cummins engine at no more than 3/4 of full throttle for first 25 hours. For next 25 hours, operate at full throttle for short periods only.

CAUTION

Always keep engine covers closed while engine is running.

Stopping the Engine

Operate the engine at idle speed for a few minutes before turning it off. This provides an opportunity for engine coolant and lubricating oil to carry heat away from critical engine areas.

Do not "gun" engine before shut down; this practice causes raw fuel to remove oil film from cylinder walls and dilute lubricant in the crankcase.

CUMMINS ENGINE: To stop Cummins Engine, turn ignition key counterclockwise to OFF position.

DETROIT DIESEL ENGINE: To stop Detroit Diesel Engine, depress ENGINE SHUTDOWN button and hold until engine has stopped completely. Turn IGNITION key to OFF position.

EMERGENCY STOP (furnished with Detroit Diesel engines only): In the event your Detroit Diesel engine continues to run after attempting to stop the engine in the normal manner, depress the **EMERGENCY ENGINE SHUTDOWN** button. Turn **IGNITION** key to **OFF** position.

CAUTION

Use "EMERGENCY ENGINE SHUTDOWN" button only in emergency. Button closes a valve preventing flow of air to engine and may cause oil to be sucked past seals and into blower housing. Engine cannot be started until valve is reset manually.

Repair cause of malfunction before restarting engine.

EMERGENCY STOP VALVE (Detroit Diesel only)

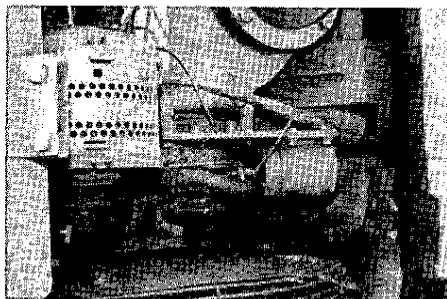

LOCATION

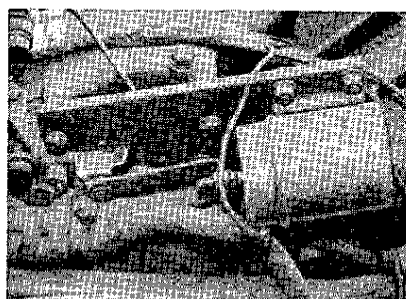

STOP POSITION

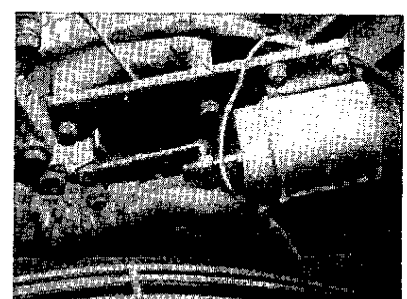

RUN POSITION

WARM UP & OPERATIONAL CHECKS

(To be performed at beginning of each work shift)

Complete all required maintenance before operating crane.

The safety, efficiency and service life of your crane will be increased by performing the operational checks indicated while waiting for the crane systems to warm up. **Be sure pumps are engaged during warm up.**

While the engine is warming to minimum operating temperature, check the operation of the following:

1. Heater (depending on season)
2. Defroster Fan
3. Windshield Washer and Wiper
4. Horn
5. Head, Tail, Directional and Auxiliary Lights
6. Low Air Indicator Light (should go out when air pressure reaches approximately 60 psi)
7. Service and Reserve Air Systems (should build and hold approximately 140 psi)

After engine has reached minimum operating temperature (160° F. for Detroit Diesel and 170° F. for Cummins) check the operation of the following:

1. Parking Brake
2. Service Brake
3. Carrier Drive Train
4. Back Up Alarm
5. Steering (front and rear)
6. Rear Steering Centered Indicator
7. Torque Converter Lubricant Level (must be checked with engine running and converter lubricant at 180° to 200° F. — Lubricant should be even with upper fill and level plug on right side of transmission).

By keeping pumps engaged during engine warm up, hydraulic oil is circulated from the reservoir, through the pumps to the control valves and then back to the reservoir. This serves to warm a portion of the oil in the hydraulic system.

Hydraulic oil between the control valves and the actuating components has not been circulating and is still cold. It is important that this oil be warmed

also. Before warming this oil and continuing with the operational checks, observe the hydraulic oil filter indicator lights.

WITH ONLY THE GREEN LIGHT GLOWING, all fluid returning to the reservoir is flowing through the filters and the crane may be operated.

WITH ONLY THE RED LIGHT GLOWING, all fluid returning to the reservoir is by-passing the filters and the crane **MAY NOT be operated.**

CAUTION

Continued operation with all hydraulic fluid by-passing the filters (red light glowing) can cause severe damage to hydraulic system components.

WITH BOTH RED AND GREEN LIGHTS GLOWING, some fluid is flowing through the filters and some fluid is by-passing the filters. This is normal during warm up and the crane may be operated slowly under light or no load to hasten warm up.

IF RED LIGHT CONTINUES TO GLOW after system has reached operating temperature, check the condition of filters in hydraulic reservoir. Dirty filters will cause continuing by-pass of fluid.

When hydraulic filter indicator lights indicate that the crane may be operated, perform the following operational checks:

1. Main and auxiliary Winches (check brake action and also action of free fall if so equipped)
2. Anti-Two Block device (if so equipped)
3. Boom Hoisting and Lowering
4. Boom Extension and Retraction
5. Swing (with and without automatic brake)
6. Outrigger Beam Extension and Retraction (all)
7. Outrigger Jack Extension and Retraction (all)

CARRIER OPERATION

Brake System

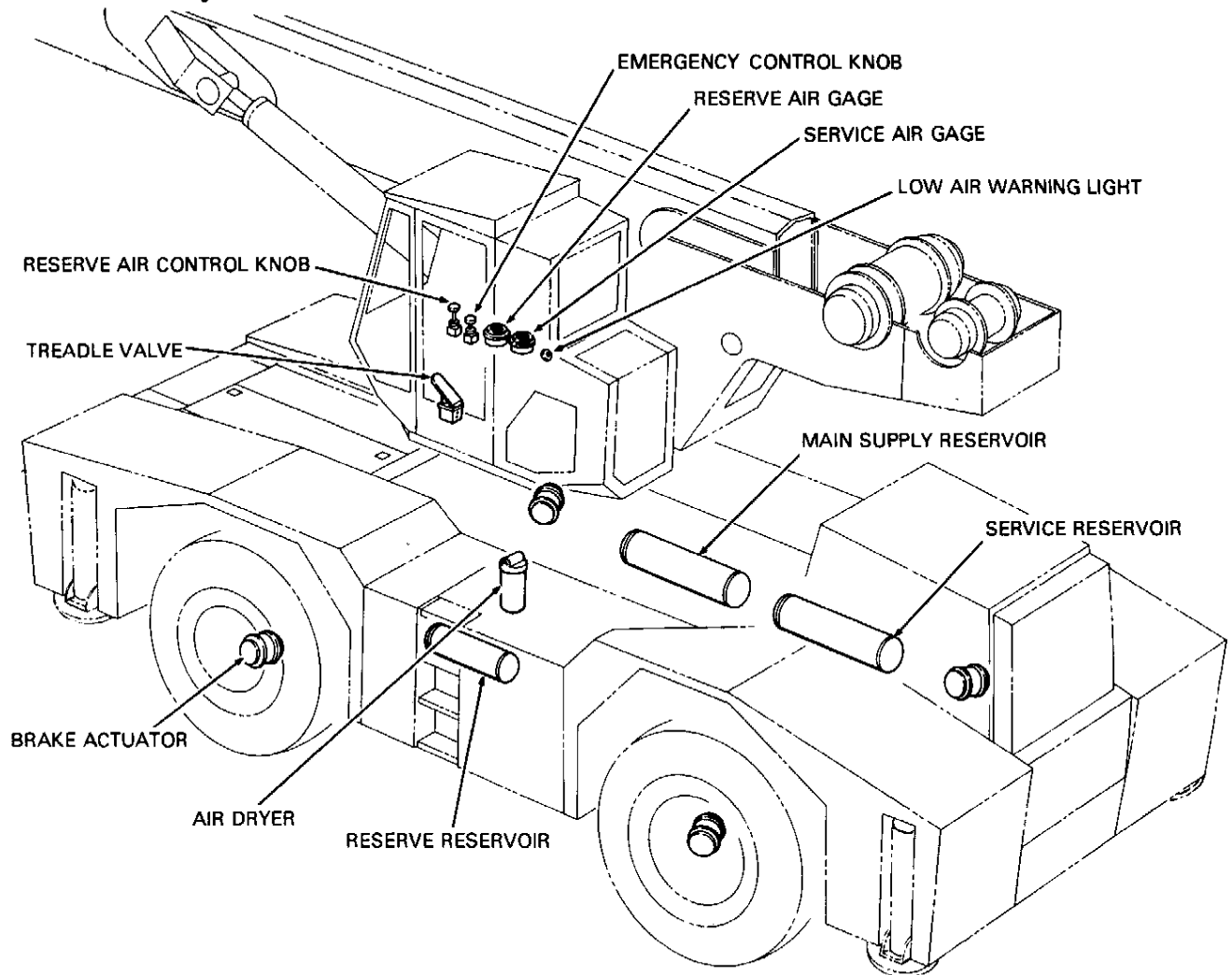

The air brake system furnished on the crane carrier includes a service brake, a parking brake and a fail safe type emergency brake. The service brake is air applied and the parking and emergency brakes are spring applied. Service, parking and emergency brakes are applied to all wheels of the carrier.

Service Brakes

Foot pressure on the brake treadle activates the service brakes. Just as in an auto, the greater the foot pressure, the harder the brakes are applied.

WARNING

Do not "fan" the brake valve treadle. A long series of rapid brake applications can reduce system pressure to a point where effective service braking will be lost until air compressor can restore pressure.

In the event air pressure in the service brake portion of the system drops below 60 psi, the LOW AIR warning light will glow. **When this condition exists, stop the carrier as soon as possible.** Do not resume operation until proper operating pressure can be maintained (60 to 140 psi in the service system).

NOTE: When pressure in the service brake portion of the system is below 60 psi, the transmission HI/LO range cannot be shifted from the position it is in. This shift can only be made while the service brakes are being applied with a minimum of 60 psi pressure.

Parking Brakes

The parking brake can be applied by raising the EMERGENCY brake control knob. This causes air pressure to be vented from spring chambers of brake actuators allowing springs to expand and apply brakes.

Release parking brake by depressing EMERGENCY brake control knob. It is not recommended that the parking brake be released until the service brake system has reached at least 60 psi and the LOW AIR warning light has gone out. Below 60 psi there is insufficient air pressure to cause a full application of the service brakes.

Emergency Brakes

The emergency brake can be applied manually by raising the EMERGENCY brake control knob. This causes air to be vented from spring chambers of brake actuators allowing springs to expand and apply brakes.

When pressure in the service brake portion of the system exceeds 40 psi, the emergency brake can be released by depressing and holding the EMERGENCY brake control knob.

If pressure in the service brake portion of the system drops below 40 psi, the EMERGENCY brake control knob will raise automatically to cause an application of the emergency spring brakes.

With pressure in the service brake portion of the system below 40 psi, the emergency brake cannot be released fully by depressing the EMERGENCY brake control knob. In this event, if it is necessary to move the carrier, reserve air pressure can be used to release the emergency brakes.

Reserve Air Pressure

Reserve air pressure is provided only to enable the operator to move the crane out of a hazardous position after an automatic application of the emergency brakes. **Reserve air is not to be used for continued driving.**

WARNING

Reserve air pressure can only be used to release the emergency spring brakes; **IT CANNOT BE USED TO APPLY THE SERVICE BRAKES.**

During normal operation, the reserve air reservoir will be pressurized to 140 psi. When reserve air pressure drops below 65 psi, there will be insufficient pressure to release the emergency spring brakes completely.

To release an automatic application of emergency brakes, depress RESERVE air control knob. This releases brakes by pressurizing spring chambers in brake actuators.

WARNING

When RESERVE air control knob has been depressed to release the emergency brake, it must be raised manually to reapply the brake. Remember, service brakes are ineffective after an automatic application of the emergency brakes.

Steering System

Front Wheel Steering

As long as the upperstructure is facing forward with respect to the carrier, front wheel steering works like steering in an automobile; turning the steering wheel to the left or right causes a corresponding left or right turn of the vehicle.

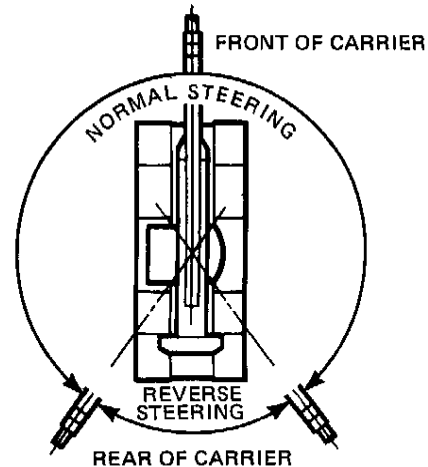

When the upperstructure is facing rearward with respect to the carrier, front wheel steering is reversed. For example, always turn the steering wheel left to make a left turn. Reversal occurs automatically when the upperstructure has been swung to the approximate area shown.

CAUTION

Holding steering wheel in full left turn or full right turn position will cause system to overheat. This can cause steering pump to fail.

General

The Self-Propelled Crane is equipped with independent front wheel and rear wheel steering to permit precise positioning in tight quarters. In some modes of operation, steering "feel" may seem unusual. **Practice all steering operations in a safe, open area** until you are thoroughly familiar with the reaction of the crane to all steering controls.

Steering Controls & Indicator

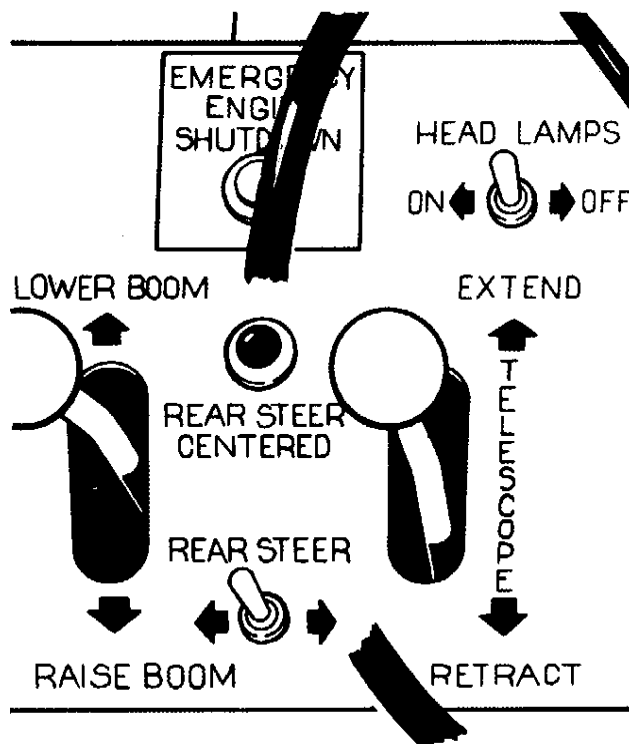

WARNING

Be alert for any increase in effort needed to steer the carrier. If any difference is noted, notify maintenance personnel immediately. If power assist feature should fail IT WOULD BECOME VERY DIFFICULT TO STEER CARRIER. THEREFORE, NEVER TURN ENGINE OFF WHILE CARRIER IS MOVING.

If power steering fails, bring carrier to a safe stop as soon as possible. Do not drive unit until problem has been corrected.

Rear Wheel Steering

Rear wheel steering is controlled by the REAR STEER toggle. Moving the toggle to the left angles the rear wheels to the left causing a right turn. Moving the toggle to the right angles the rear wheels to the right causing a left turn.

Rear wheel steering is not reversed when the upperstructure is swung to the rear.

The REAR STEER CENTERED indicator light is provided to permit centering of rear wheels when they are out of view. The indicator light will glow when the rear wheels are off center and will go out when the wheels are centered.

Study Steering Diagrams On Following Pages

Steering While Traveling Forward

FRONT WHEELS ONLY

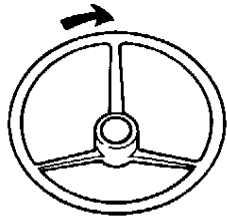
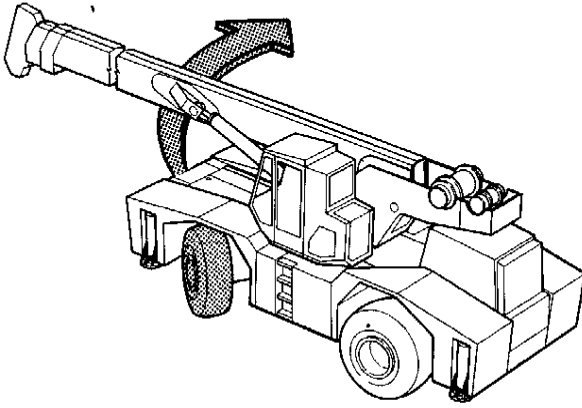

REAR WHEELS ONLY

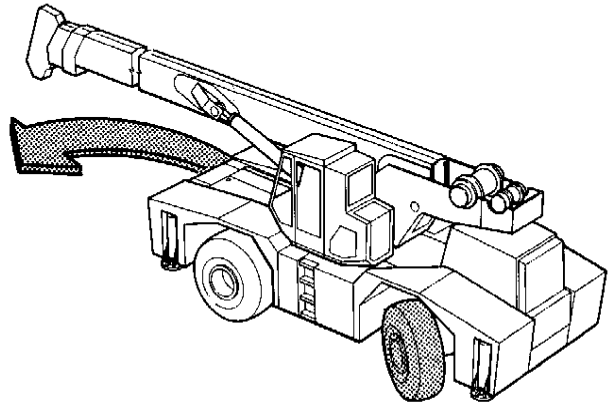

FRONT & REAR WHEELS COORDINATED

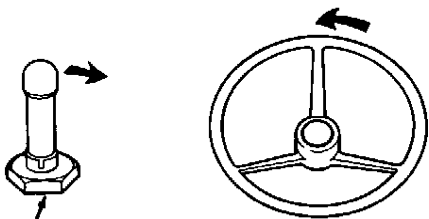
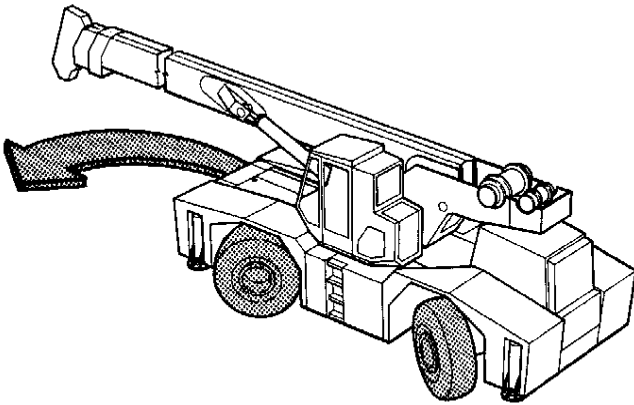

REAR STEER TOGGLE

FRONT & REAR WHEELS CRABBING

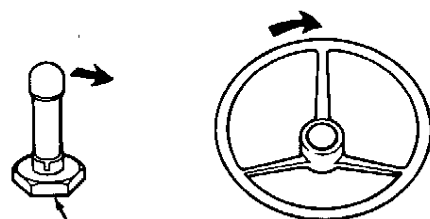
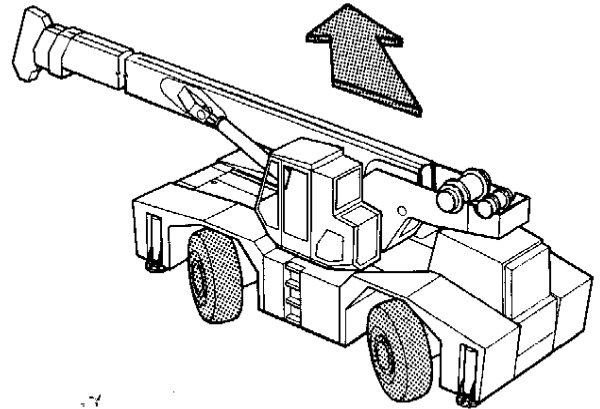

REAR STEER TOGGLE

Steering While Traveling Rearward

FRONT WHEELS ONLY

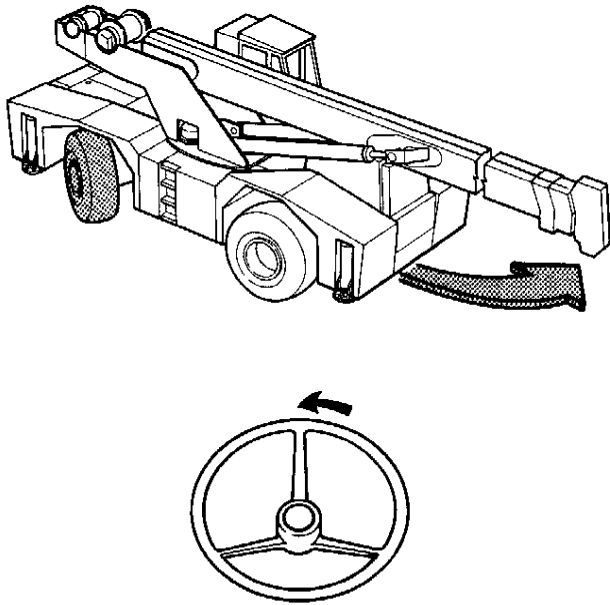

REAR WHEELS ONLY

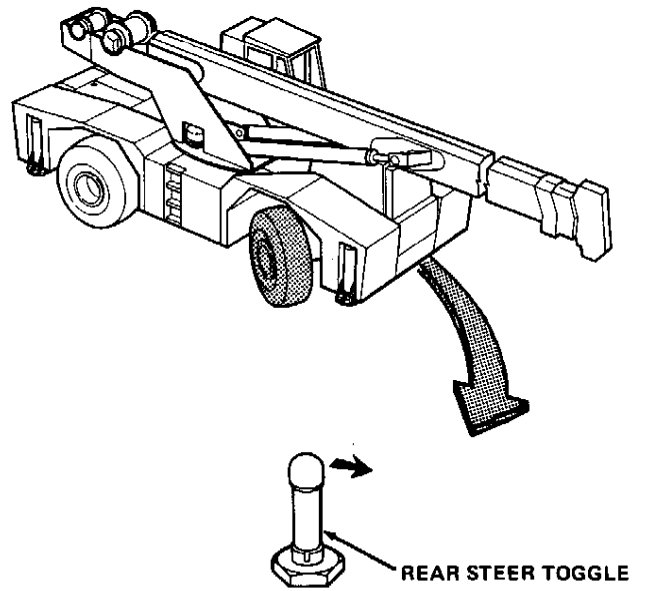

FRONT & REAR WHEELS COORDINATED

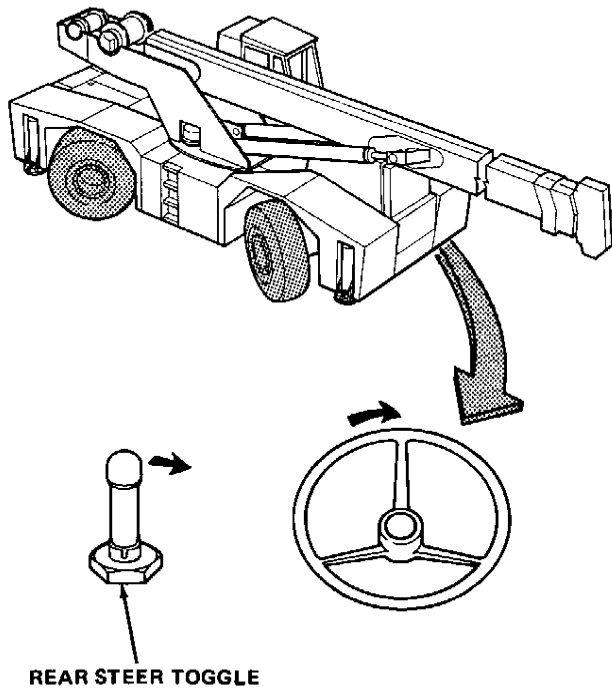

FRONT & REAR WHEELS CRABBING

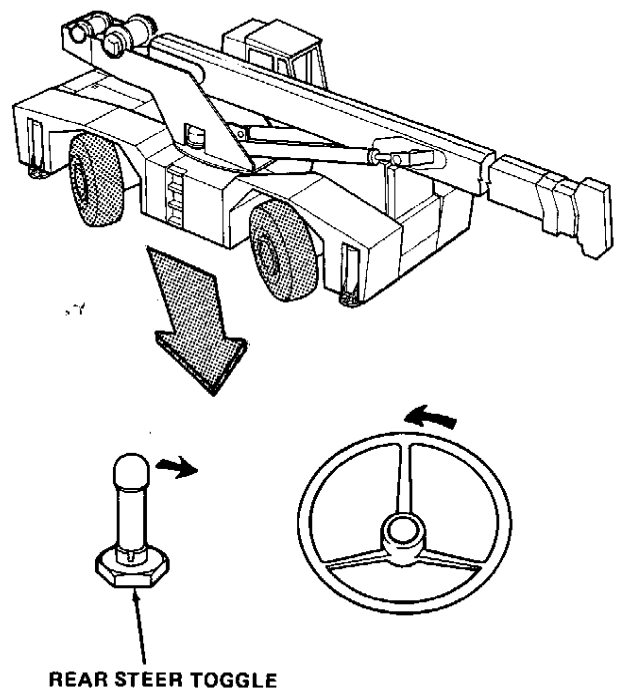

Rear Axle Oscillation

General

The rear axle has an oscillation type suspension. This provides a rigid base for making light lifts over the side without outriggers but still permits the rear wheels to follow ground contour when traveling over rough terrain.

Normal Oscillation

When the crane is in travel position (front of upperstructure aligned with front of carrier, house lock engaged, jib and Side Fly stored and boom fully lowered and retracted) a switch is automatically activated to permit oscillation.

Under this condition the oscillation cylinders will drift freely permitting the rear axle to oscillate as the rear wheels follow the contour of the ground.

Oscillation Lock

When the front of the upperstructure is swung away from the front of the carrier, the switch is automatically deactivated and the oscillation

cylinders are hydraulically locked to cause a rigid connection between the rear axle and the carrier frame.

Oscillation Lock Override

If the crane is being positioned on uneven ground with the boom over the side, the locked oscillation cylinders could cause one of the rear wheels to leave the ground.

The OSCILLATION LOCK OVERRIDE pushbutton is provided to release the cylinders temporarily. Depress the button until the raised wheel has settled firmly on the ground and then release the button.

WARNING

The OSCILLATION LOCK OVERRIDE is provided only as an aid for positioning the crane. Depressing the button when the crane is under a load will reduce stability dangerously.

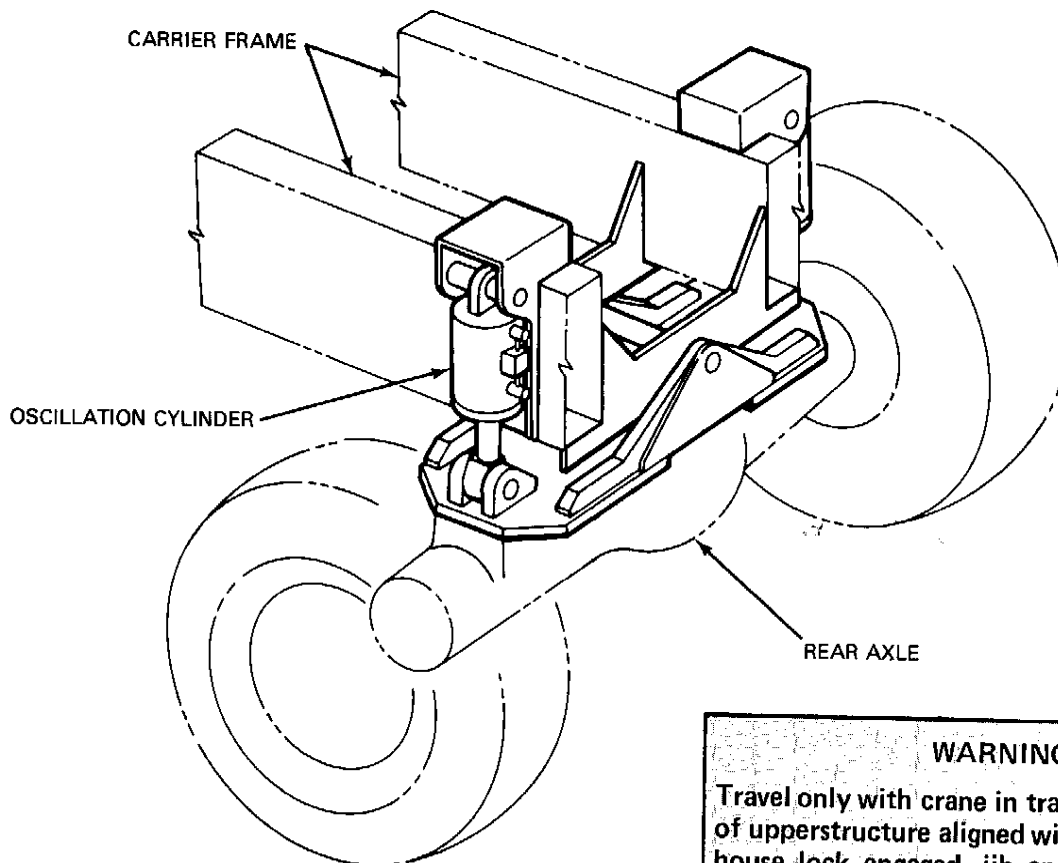

WARNING

Travel only with crane in travel position (front of upperstructure aligned with front of carrier, house lock engaged, jib and Side Fly stored and boom fully retracted and lowered).

Drive Train

Torque Converter

There are no operator controls for the torque converter. It functions automatically to permit starting from a standstill in any transmission speed range.

Torque converter oil temperature and oil pressure gages are provided to monitor torque converter operation. Normal operating temperature is 180° to 200° F. and operating pressure is 180 to 220 psi with the oil at operating temperature and the engine running at 2000 RPM.

Transmission

The transmission provides six speeds forward and six speeds reverse: 1st, 2nd and 3rd in both high and low ranges.

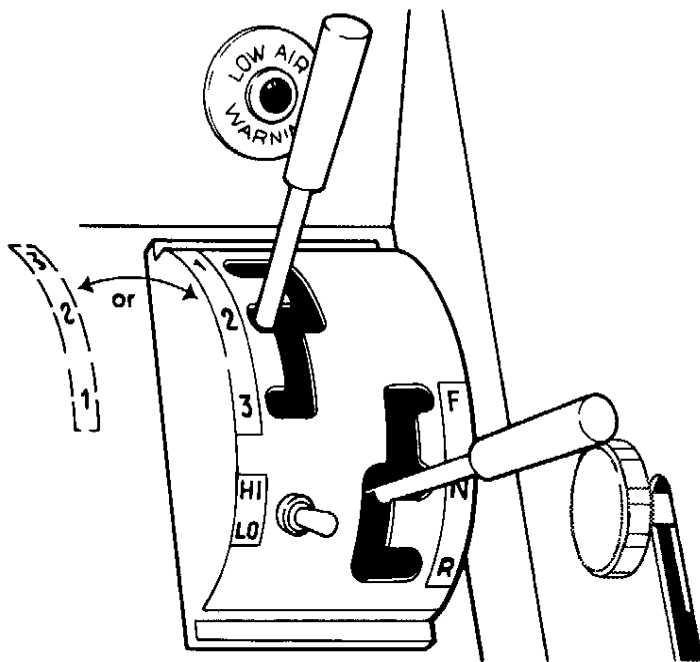

There are three operator control switches for the transmission: the gear selector (1, 2 and 3); the range selector (LO and HI); and the direction selector F (forward), N (neutral), and R (reverse).

NOTE

An electrical interlock in the transmission circuitry deactivates transmission HI/LO control until brake treadle is fully depressed. If brake system pressure is below 60 psi, or if the direction selector is not in neutral, the HI/LO control will be inoperative.

WARNING

Wait until the brake system has reached full operating pressure before driving the carrier.

To operate the transmission, perform the following procedure:

1. Depress the brake treadle fully and hold.

CAUTION

Shift the HI/LO selector and the direction selector **ONLY** when the carrier is stopped. Shifting these controls while traveling could cause serious transmission damage.

2. With directional selector in neutral, move HI/LO selector to desired speed range.
3. Move gear selector to desired gear (1, 2 or 3).
4. Move direction selector to F (forward) or R (reverse) as desired.
5. Release parking brake if applied.
6. Release brake treadle and depress accelerator to obtain desired speed.
7. Stop carrier by releasing accelerator and depressing the brake treadle.
8. When carrier has stopped, continue to hold the brake treadle. Move direction selector to N (neutral) and move gear selector to 2.
9. Apply the emergency brake and release the brake treadle.

Two & Four Wheel Drive

There are no operator controls for two and four wheel drive. When the transmission range selector is moved to LO, four wheel drive is engaged automatically. Moving transmission range selector to HI causes rear axle drive to be disengaged automatically.

CAUTION

Use LO range when driving on unimproved surfaces.

Parking

PRECAUTIONS:

Avoid parking on banks, a slope or near an excavation.

Avoid parking on roads or highways. If it cannot be avoided be sure to display warning flags during

day and flares or flashing lights at night.

Park on level ground and block wheels.

If parking on a slope cannot be avoided, position unit at right angle to slope and block wheels.

Parking Procedure

1. Position crane in a safe parking area.
 2. Depress brake treadle and hold while moving direction selector to N (neutral), gear selector to 2 and range selector to HI.
 3. Apply EMERGENCY brake and release brake treadle.
 4. If heater is being used, turn it off.
- NOTE: After heater is turned off, heater fan will continue to run until heater cools to a preset point and then stop automatically. While heater fan is running, HEATER ON indicator light will continue to glow, even after ignition is turned off.
5. Lower load to rest. Retract boom sections and lower boom fully if possible. Never leave operator's seat with load suspended.
 6. Allow engine to cool at idle speed for a few minutes and then turn off. Remove ignition key.
 7. Fill fuel tank to minimize condensation.
 8. Lock cab and storage compartments.
 9. Disconnect batteries if unit is in an area where tampering seems possible.

Towing

WARNING

If the crane is disabled and cannot be driven safely under its own power, do not attempt to tow it. Load crane onto a suitable carrying vehicle for transport to a repair facility.

If the crane can be driven safely under its own power but is stuck in soft ground, mud, etc., it may be towed a short distance to solid ground if all of the following conditions are met:

1. A qualified operator is stationed at crane controls to drive crane as required.
2. Engine is running and pumps are engaged.
3. Brake and steering systems function properly.
4. Boom is fully retracted and lowered.
5. Side Fly and jib are properly stored (if so equipped).
6. Outrigger beams and jacks are fully retracted and jack floats are stored.
7. House lock is engaged.
8. The ground over which crane must be towed will not cause crane to upset.

OUTRIGGER OPERATION

Fully extended - 21'.

The headings above each individual capacity chart, located in the operator's cab, identify the position of the Outrigger Beam.

Two types of **Outrigger Systems** are provided.

1. Conventional Outrigger Beams have two positions: Fully retracted - 9'3" Fully extended - 21'.
2. Variable Outrigger Beams have three positions: Fully retracted - 9'3" Mid-extension - 14'8"

PRECAUTIONS:

1. Be sure ground is firm enough to support loaded jack floats; if it isn't, use mats under jack floats.
2. When equipped with **conventional two-position Outrigger System**, all outrigger beams must be extended fully when lifting "ON OUTRIGGERS." When equipped with **variable three-position Outrigger**

System, all outrigger beams must be extended to the same length, fully retracted, mid-extension, or fully extended.

3. Use mats if there is a possibility of jack floats being frozen in ground.
4. If a jack cylinder shows signs of leakage, have it repaired before using it.

Two separate control switches are provided for each outrigger, one for Outrigger Beam extension and retraction and one for Jack extension and retraction.

An outrigger MASTER SWITCH is provided to minimize the possibility of accidental actuation of the outriggers. Electrical power to all outrigger beam and jack switches is supplied through the MASTER SWITCH. When the MASTER SWITCH is held in the ON position, outrigger beam and jack switches will be energized. When the MASTER SWITCH is released, it returns to the OFF position automatically and outrigger beam and jack switches are de-energized.

Extending Outriggers

After checking to be sure crane is positioned properly, extend outrigger beams and jacks by performing following procedure:

1. Apply the EMERGENCY brake.
2. Remove lock pins from all outrigger beams.
3. With boom retracted, swing upperstructure to permit a clear view of the first outrigger beam to be actuated.

WARNING
Extend or retract outrigger beams and jacks only when you have a clear view of them. If circumstances prevent a clear view, use a signal man.

WARNING
Capacities shown in the main portions of the load chart (located on panel in cab) are based on the crane being level, the outrigger beams being equally extended, and the jacks resting on a firm supporting surface.

Lock Pins

Outriggers are equipped with lock pins to prevent Outrigger movement in the event the extension cylinder drifts. Sets of lock pin holes are provided in the outrigger beams to prevent drift when beams are extended or retracted.

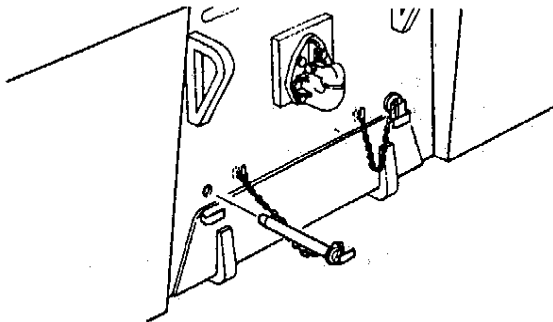

Outrigger Controls

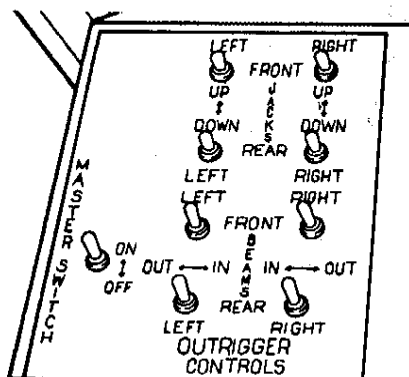

4. Push MASTER SWITCH forward and hold it in ON position.
5. Select appropriate outrigger BEAMS switch and move it in appropriate direction as indicated by decal. Hold switch in actuated position until outrigger beam is extended to required location and then release both switches.
6. Swing upperstructure to get a clear view of the next Outrigger.
7. Repeat Steps 4, 5, and 6 until all Outrigger Beams are extended equally to the desired position.
8. **Have Lock Pins installed in each Outrigger Beam.**
9. Push MASTER SWITCH Forward and hold it in ON position.
10. Select appropriate JACKS Switch and move it in the direction indicated on decal. Hold Switch in actuated position until Jack has started to raise the corner of the machine.

11. Swing upperstructure to get a clear view of the next Jack on the same end of the machine. Repeat Step 10.
12. Repeat Steps 9, 10, and 11 until the tires have been relieved of enough weight to eliminate the bulge at ground contact point.

Leveling Carrier

Observe the leveling Indicator next to the Outrigger Switches. Level the carrier by actuating the MASTER SWITCHES and the appropriate Jack Switches until both bubbles are centered in the leveling vials.

Check to be sure some of the tires are still in contact with the ground. Be sure the weight has been removed to eliminate tire bulge.

Retracting Outriggers

Jacks and Outrigger Beams can be retracted in the reverse order of extension. Be sure of a clear view before actuating Jacks or Outrigger Beams.

Be sure to remove Lock Pins before actuating Outrigger Beams. Install Lock Pins to secure Outrigger Beams in stored position.

CAUTION
Do not extend Jack Cylinders fully. When fully extended, Jacks can be damaged by thermal expansion of hydraulic oil. A damaged Jack could cause crane to tip over.

WARNING
Observe extend of Jack Float penetration. If ground is too soft to provide solid support for Jacks, use mats as required under Jack Floats.

Jack Float Storage

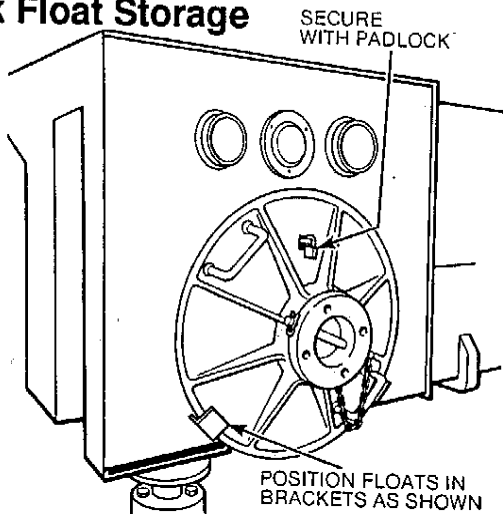

WARNING
Store Jack Floats as shown for road travel.

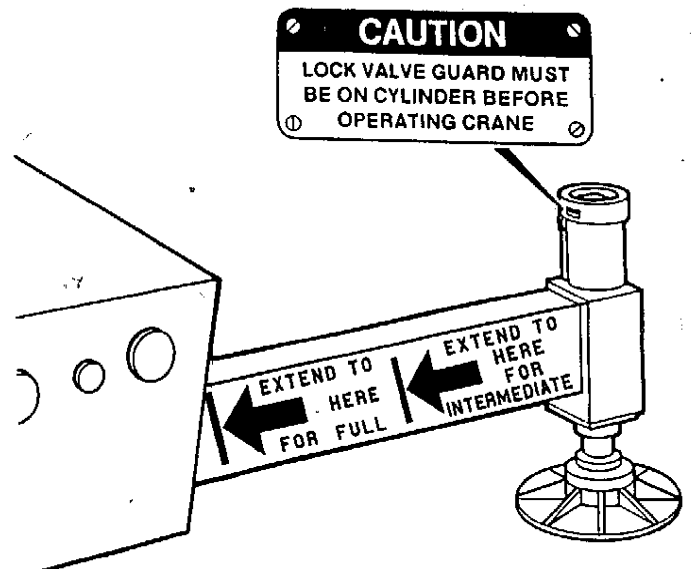

BOOM SECTION NO. 4, SIDE FLY® & JIB (optional equipment)

Study load rating chart for limitations governing use of boom section no. 4, Side Fly and jib.

Keep boom section no. 4, Side Fly and jib properly secured in storage position when not in use.

If Side Fly is being used but jib is not required, store jib on boom section no. 1. Never carry jib beneath working Side Fly.

Boom Section No. 4 Secured in Storage Position

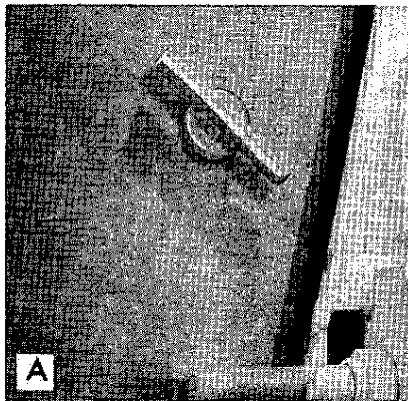
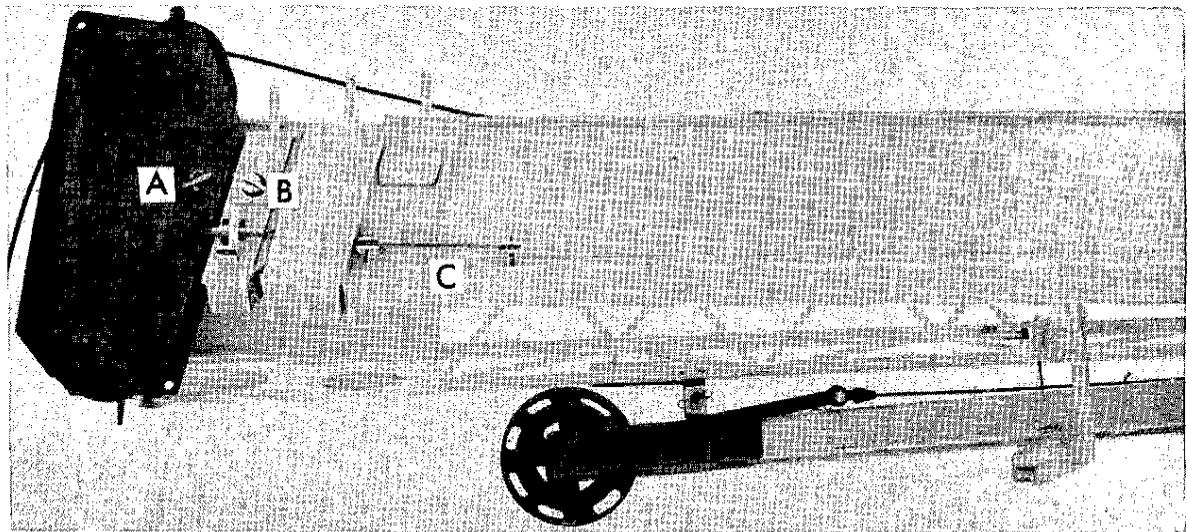

Cylinder pull pin and retainer pin installed to secure boom section no. 4 to extension cylinder

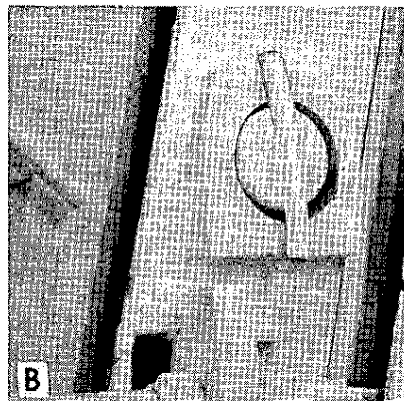

Cylinder rod anchor pin and retainer pin installed to secure boom sections 3 and 4 to extension cylinder

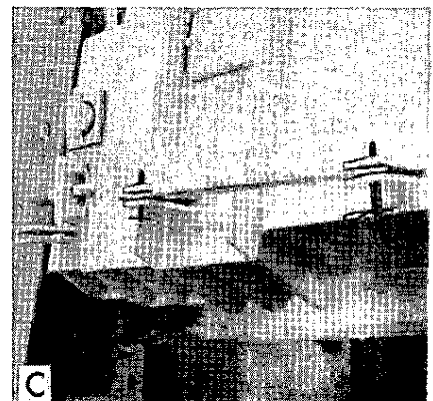

Holding link positioned in middle and rear brackets and secured with pins and retainer pins

Side Fly Secured in Storage Position

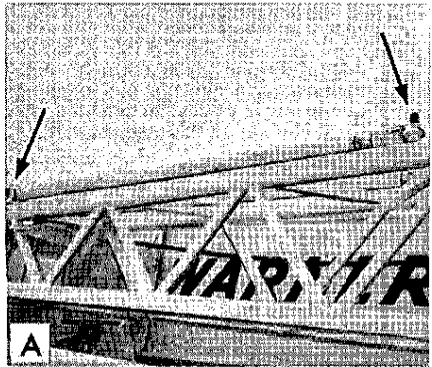

A
Retainer pins installed to secure both ends of rear gantry support rods to Side Fly (4 rods)

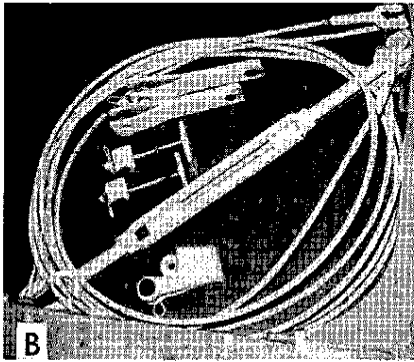

B
Rear jib pendants removed and stored in compartment at front of carrier

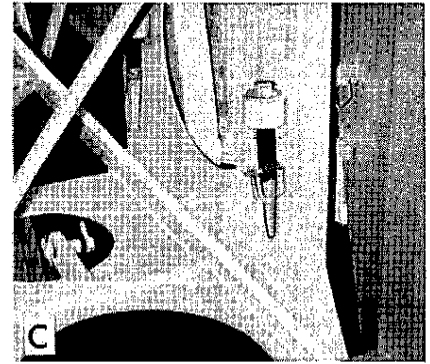

C
Retainer pins and pivot pins removed from Side Fly and stored inside base of Side Fly

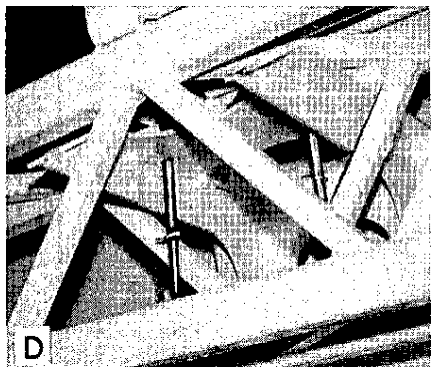

D
Pins and retainer pins installed to secure tip of Side Fly to rear support bracket

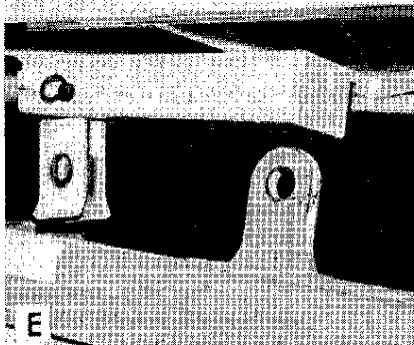

E
Roller bracket disconnected from jib lug and pinned in storage position at rear of roller track

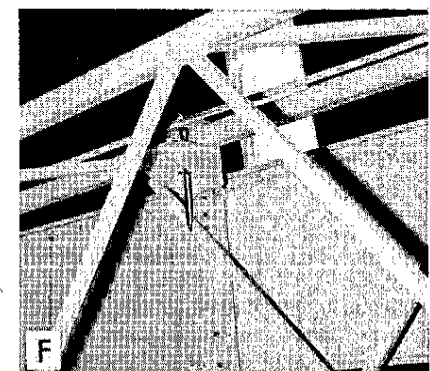

F
Pins and retainer pins installed to secure base of Side Fly to front support bracket

Jib Secured in Storage Position

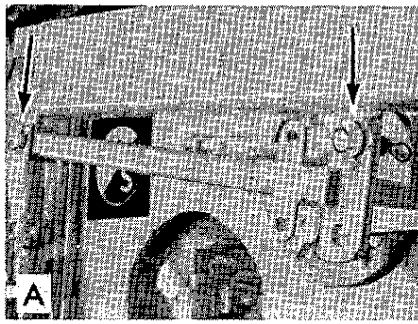

Pins and retainer pins installed to secure both ends of gantry to jib

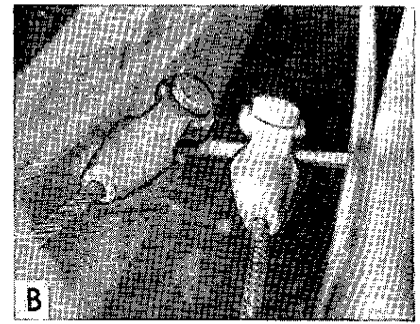

Front jib pendants secured to jib

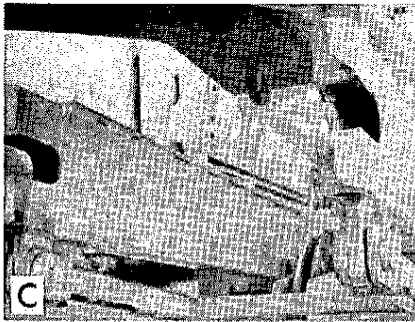

Retainer pins, pins and spacer blocks removed from base of jib and stored in compartment at front of carrier

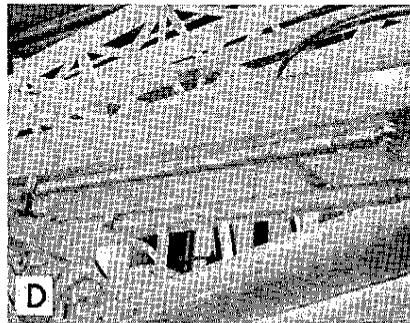

Retainer pins installed to secure both ends of front gantry support rods to jib

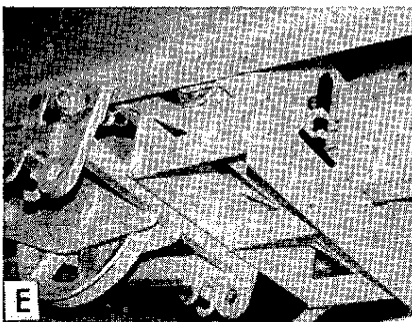
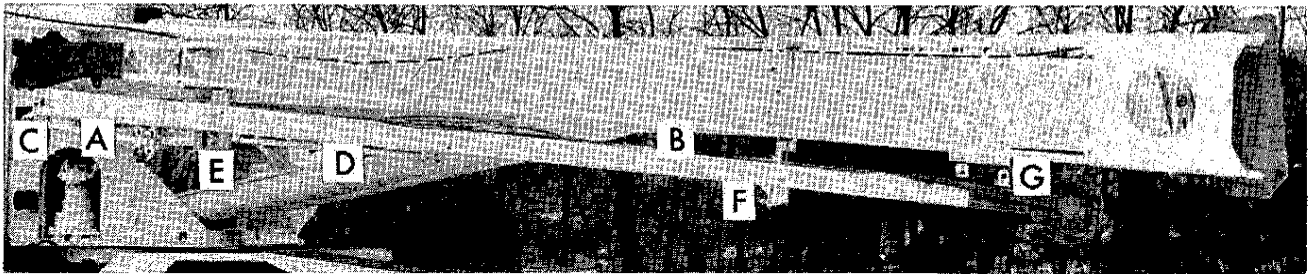

Pin and retainer pin installed to secure jib to rear support bracket

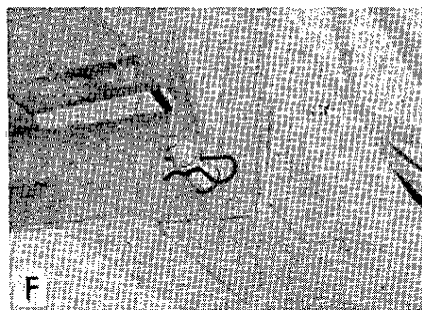

Retainer pin installed to secure jib to front support bracket

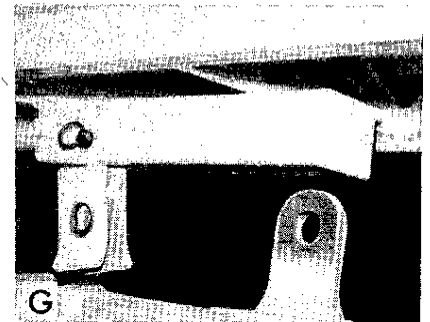

Jib lug disconnected from roller bracket and roller bracket pinned in storage position at rear of roller track

Extending Boom Section No. 4

If Side Fly and jib are required, they must be erected before extending section 4.



1. With cab facing front, retract and lower boom fully and engage house lock.



2. Extend outrigger beams and jacks to permit access to boom point from ground. Be sure all jack floats are resting on ground.

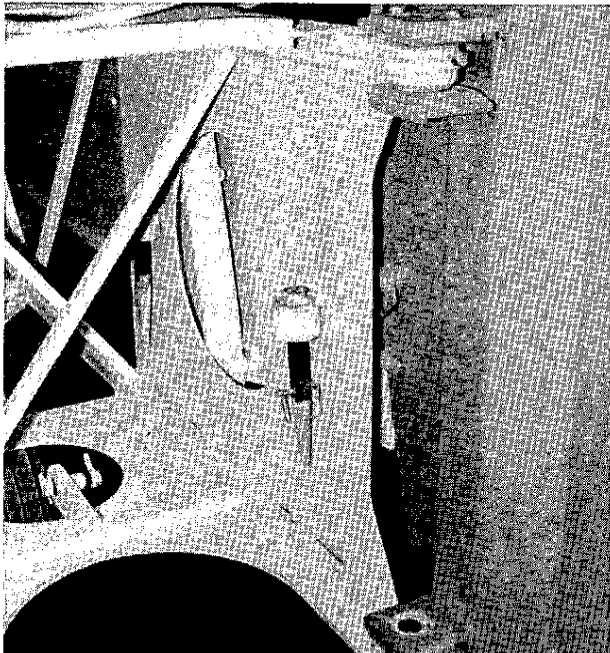

3. Check to be sure pivot pins have been removed from Side Fly pivot ears.

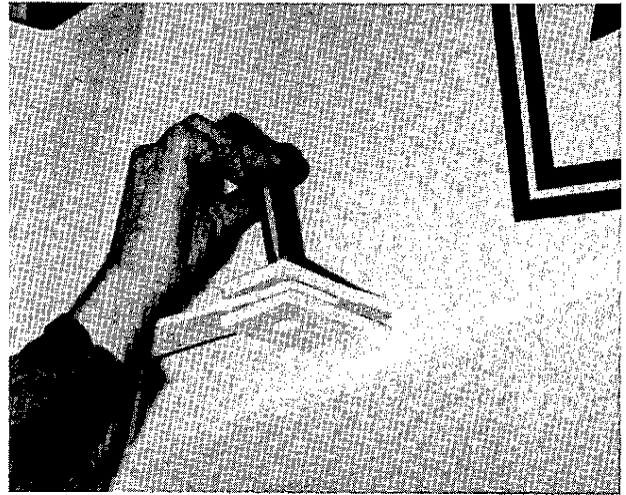

4. Remove retainer pin and pin from rear of holding link.

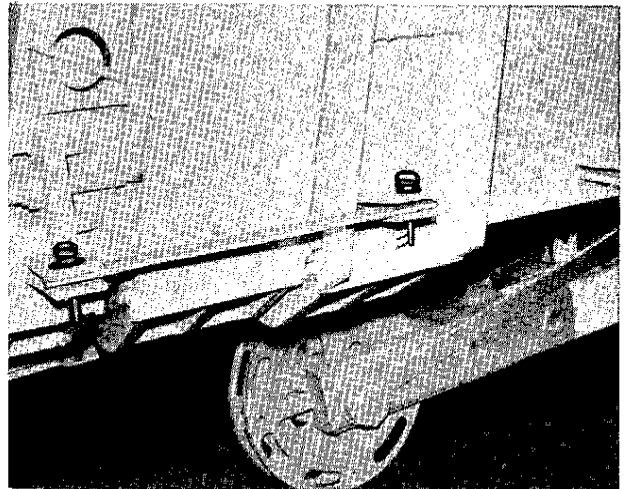

5. Reposition holding link in middle and front brackets and secure with pin and retainer pin.

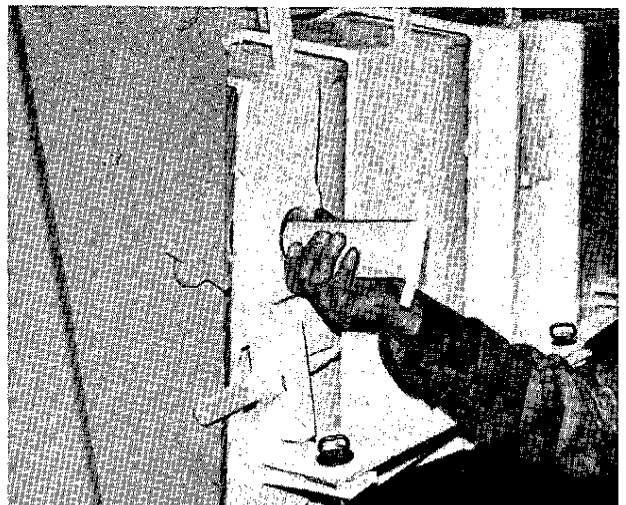

6. Remove retainer pin and cylinder rod anchor pin from boom section no. 3.

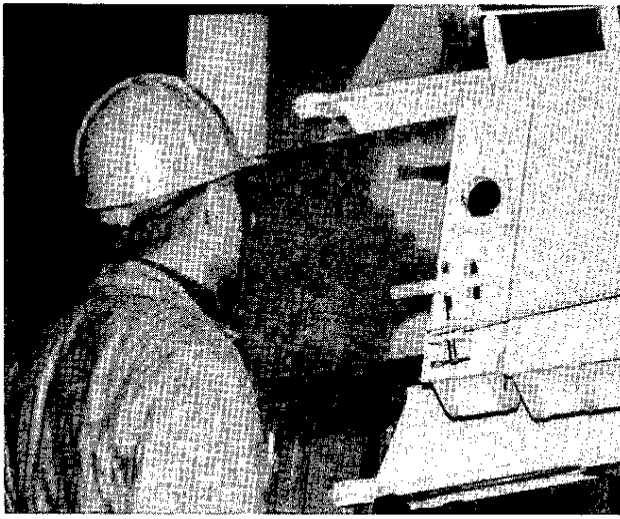

7. Position a man to watch for alignment of holes at front of section no. 3 and at rear of section no. 4 while section no. 4 is being extended. Be sure to pay out enough winch line to prevent two blocking.

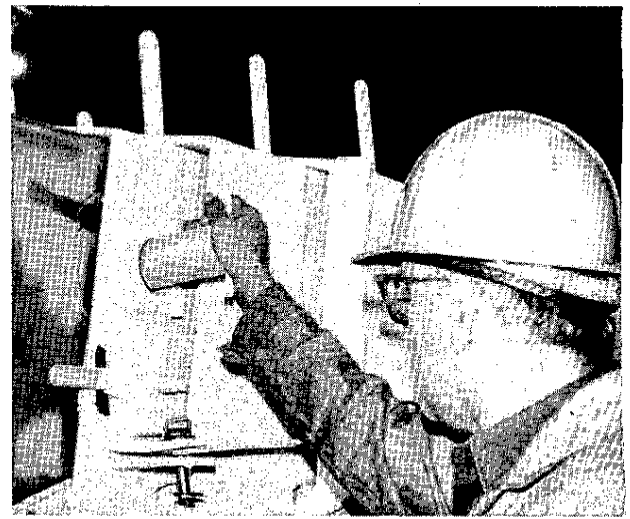

10. Install cylinder rod anchor pin through boom sections 3 and 4 and cylinder rod eye and secure with retainer pin.

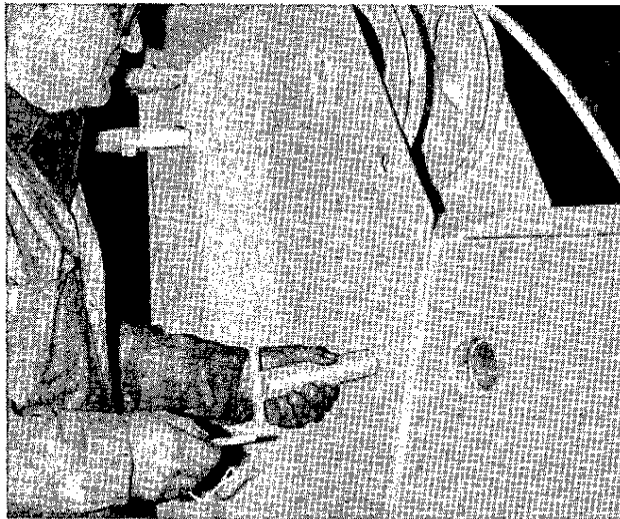

8. Remove retainer pin and cylinder pull pin from boom section no. 4. Place pins in storage compartment.

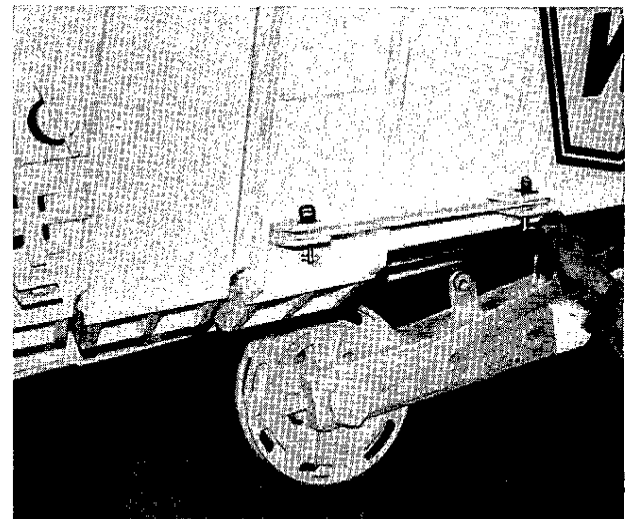

11. Remove retainer pin and pin from front of holding link. Reposition link in middle and rear brackets and secure with pin and retainer pin.

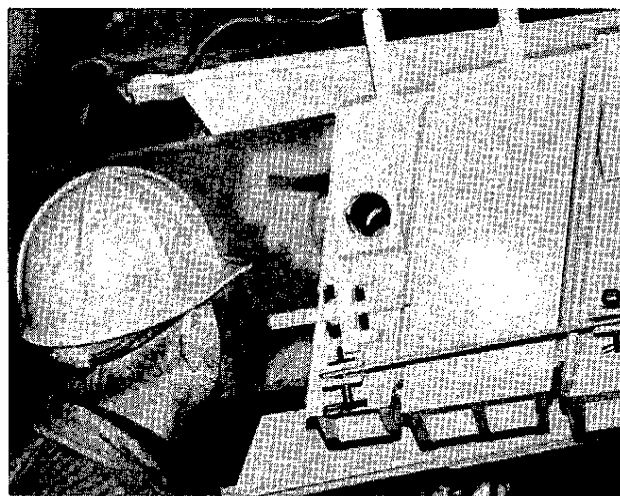

9. With a man positioned to watch for alignment, retract cylinder till hole in rod is aligned with previously aligned holes.

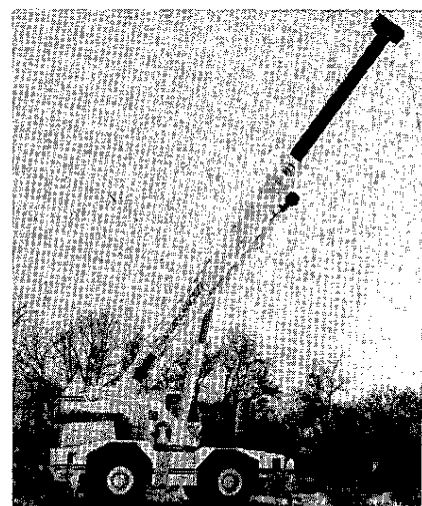

12. Level machine and raise boom to at least 55° before extending boom sections 2 and 3.

Retracting Boom Section No. 4

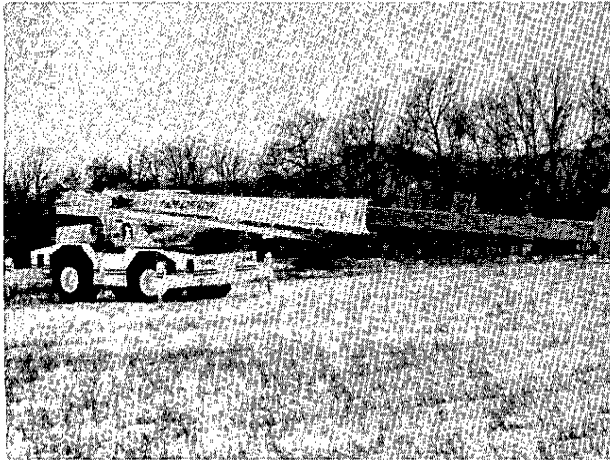

1. With machine level and cab facing front, engage house lock and retract boom sections 2 and 3 fully. Lower boom and adjust outriggers for access to boom sections 3 and 4. Be sure all jack floats are resting on ground.

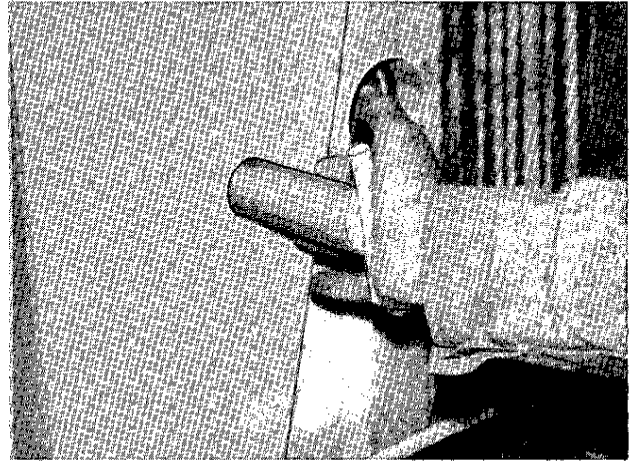

4. With a man positioned to watch for alignment, extend cylinder until cylinder pull pin holes in section 4 and cylinder are in alignment. Install cylinder pull pin and secure with retainer pin.

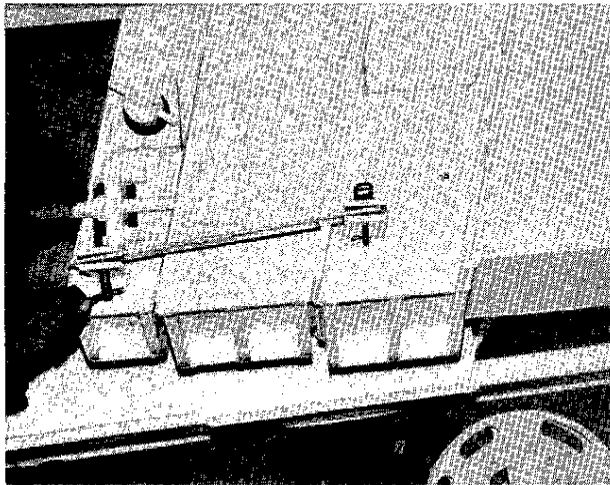

2. Position holding link in middle and front brackets and secure with pins and retainer pins.

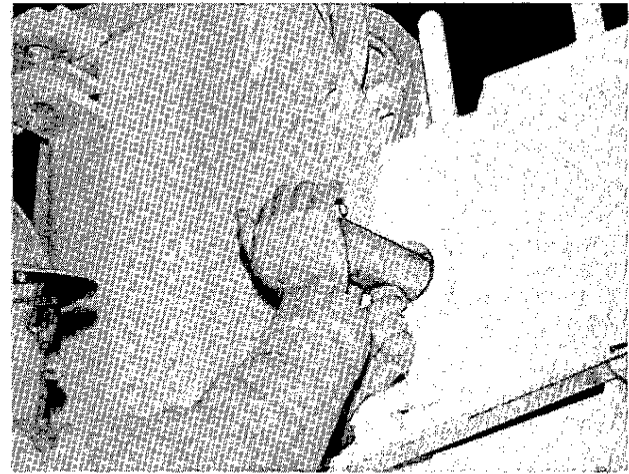

5. With a man positioned to watch for alignment, retract cylinder and boom section no. 4 until cylinder rod anchor pin holes in sections 3 and 4 and cylinder are in alignment. Install cylinder rod anchor pin and secure with retainer pin.

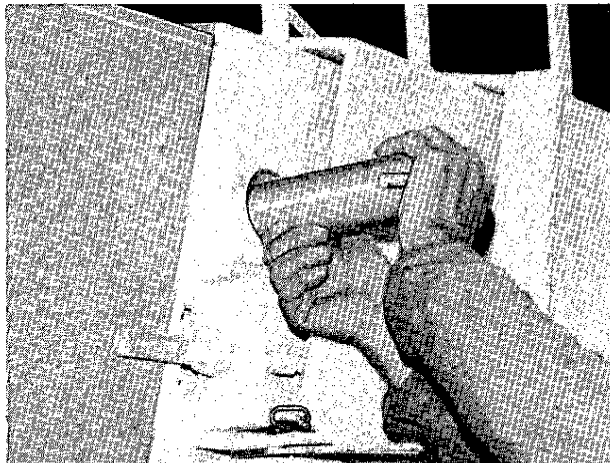

3. Remove retainer pin and cylinder rod anchor pin from boom sections 3 and 4 and cylinder rod eye.

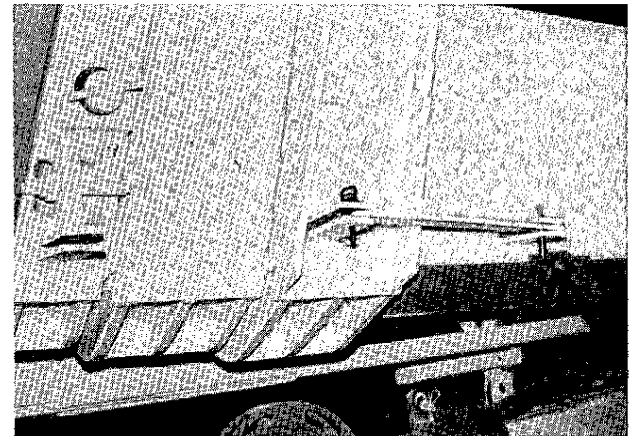

6. Position holding link in middle and rear brackets and secure with pins and retainer pins. Return Side Fly and jib to storage position if erected.

Erecting Side Fly WITHOUT Jib

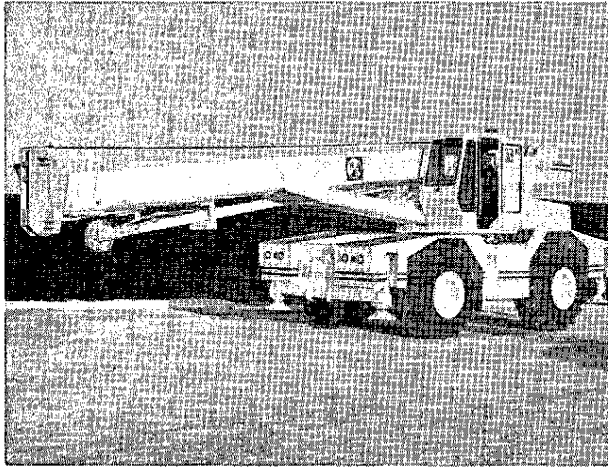

1. With cab facing front, retract and lower boom fully and engage house lock.



2. Extend outrigger beams and jacks to permit access to boom point from ground. Be sure all jack floats are resting on ground.

NOTE

Steps 3, 4 and 5 apply only to units equipped with optional jib.

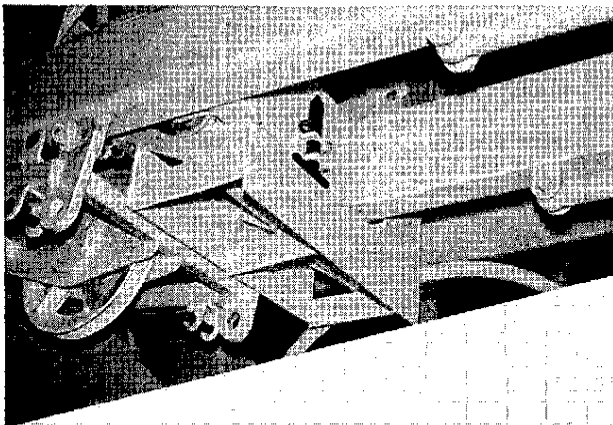

3. Check to be sure pin and retainer pin are installed to secure jib to rear support bracket.

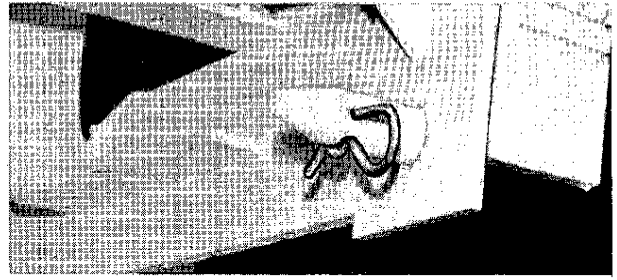

4. Check to be sure retainer pin is installed to secure jib to front support bracket.

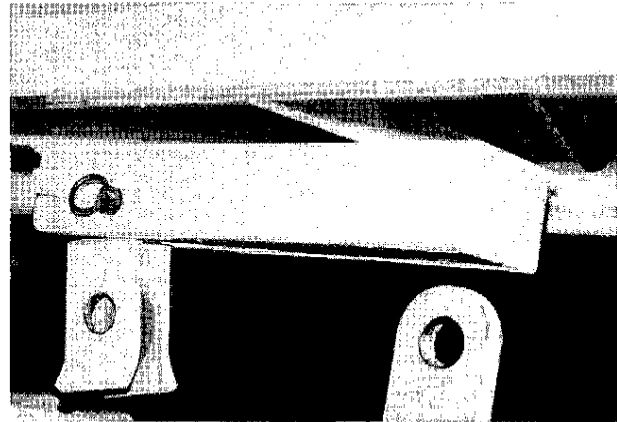

5. Check to be sure jib lug is disconnected from roller bracket and that roller bracket is pinned in storage position at rear of roller track.

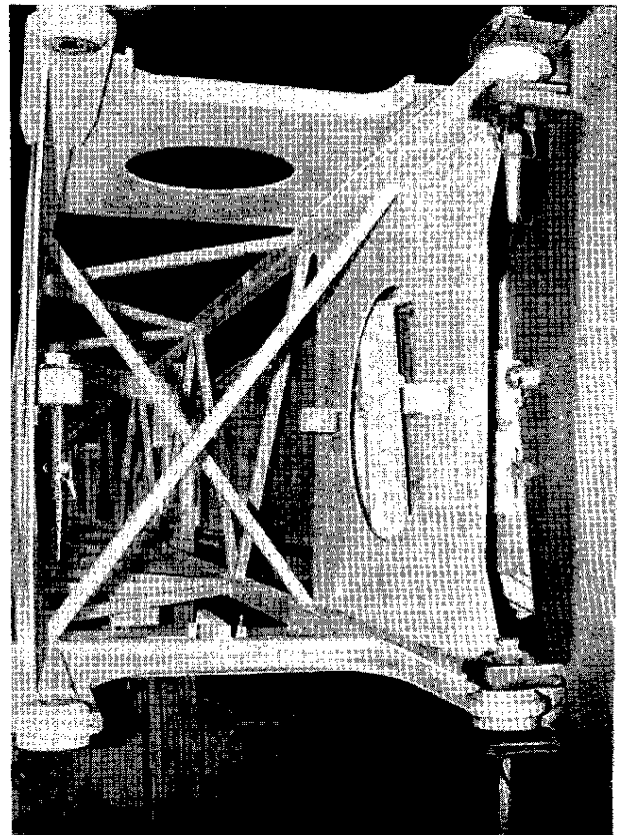

6. Remove two pins and retainer pins from storage brackets inside base of Side Fly. Connect Side Fly to boom point with two pivot pins and secure with retainer pins.

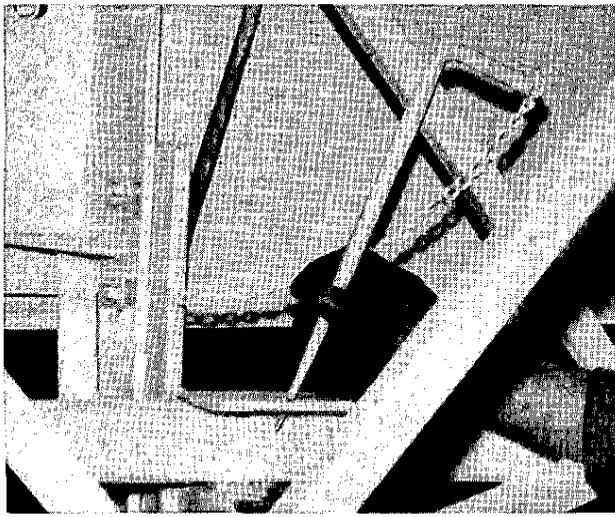

7. Remove retainer pins and Side Fly storage pins from front storage bracket.

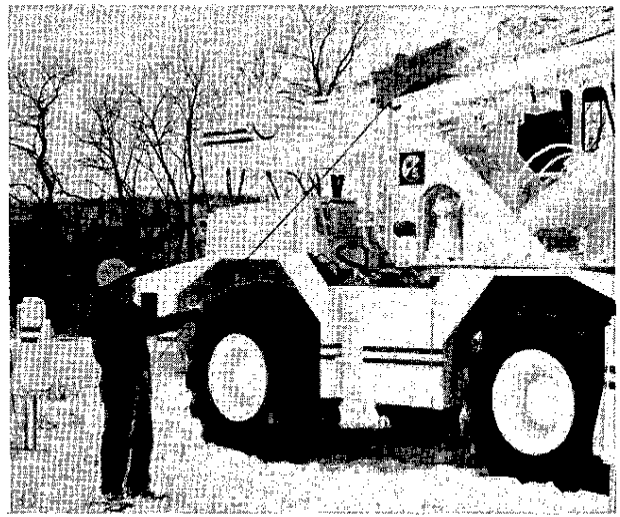

10. Using guide rope, pull Side Fly from storage bracket. Lower boom to horizontal and guide Side Fly into alignment with boom.

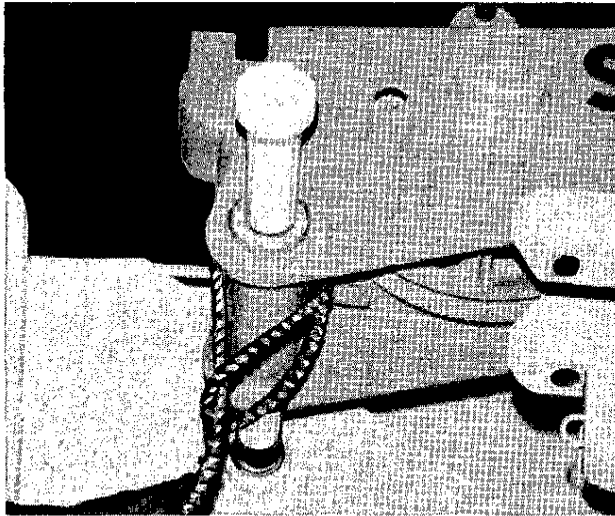

8. Attach a guide rope near tip of Side Fly.

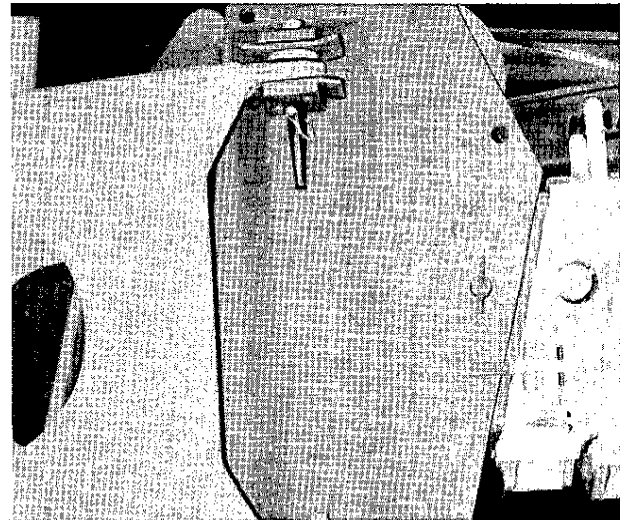

11. Lower boom for access to boom point and install anchor pins and retainer pins to secure Side Fly to boom point. Connect Side Fly portion of anti-two block system if so equipped (page 56).

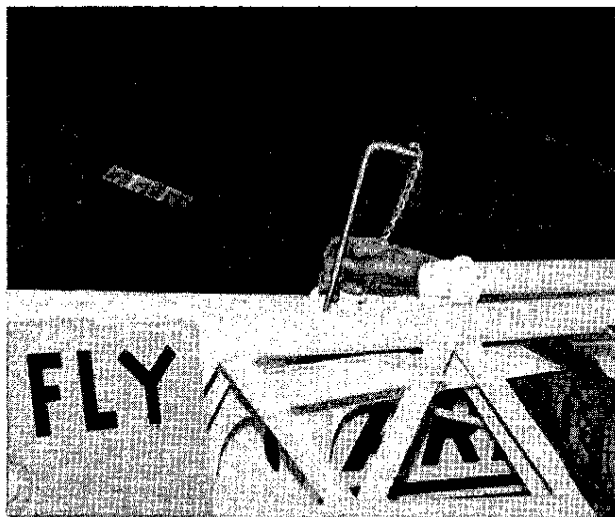

9. Raise boom to 10° above horizontal. Remove retainer pins and Side Fly storage pins from rear storage bracket.

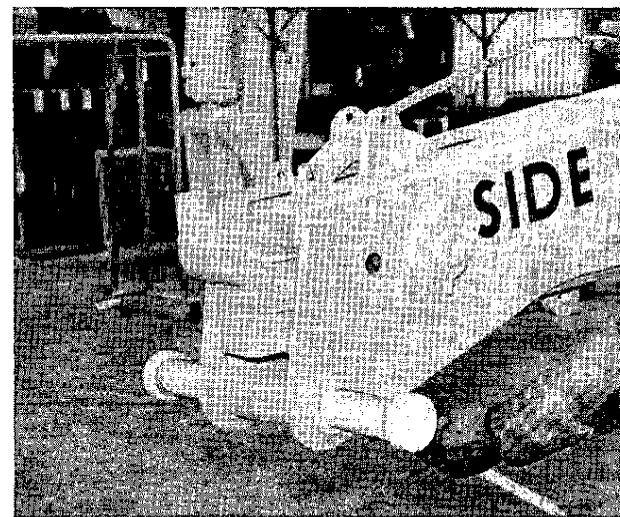

12. Remove guide rope and Reeve wire rope over Side Fly. Level machine and raise boom to at least 55° before extending boom sections 2 and 3.

Storing Side Fly WITHOUT Jib

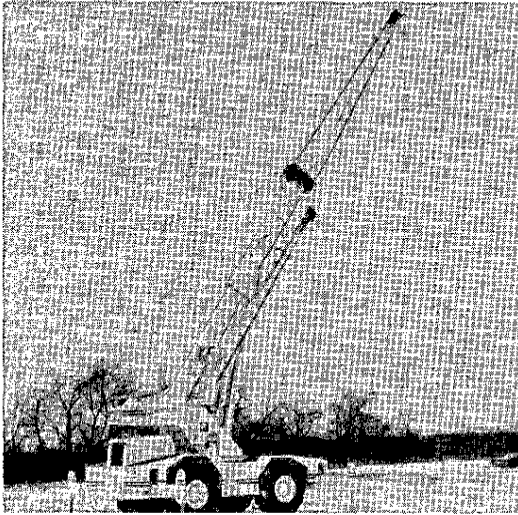

1. With cab facing front, engage house lock and retract boom sections 2 and 3.

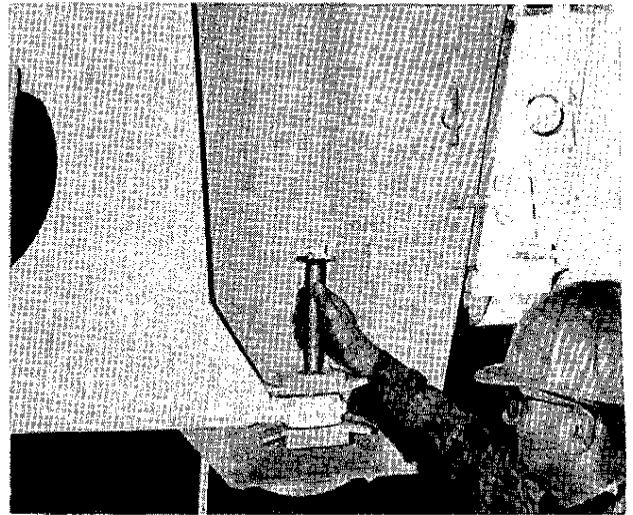

4. Remove retainer pins and anchor pins from left side of Side Fly.

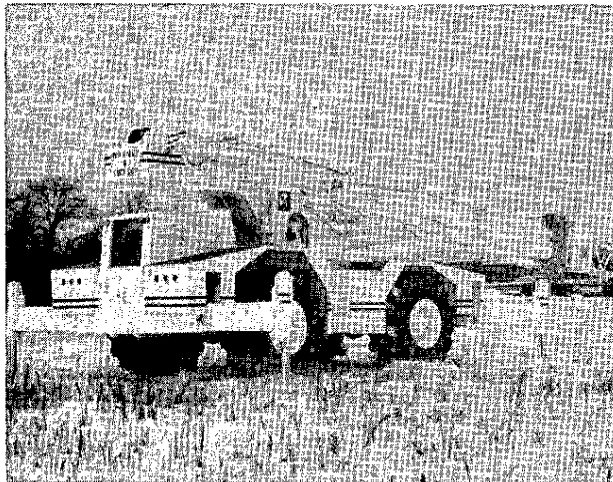

2. Lower boom and adjust outriggers for access to boom point and Side Fly. Be sure all jack floats are resting on ground. Disconnect Side Fly portion of anti-two block system if so equipped (page 57).



5. With boom raised to horizontal position, use guide rope to swing Side Fly onto storage brackets.

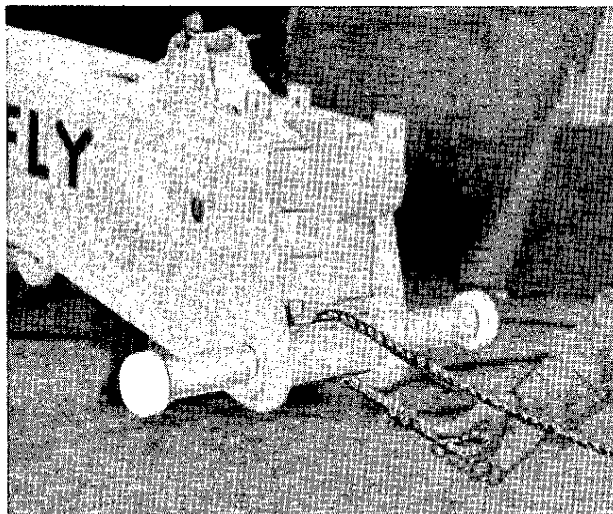

3. Unreeve Side Fly and attach a guide rope near tip of Side Fly.

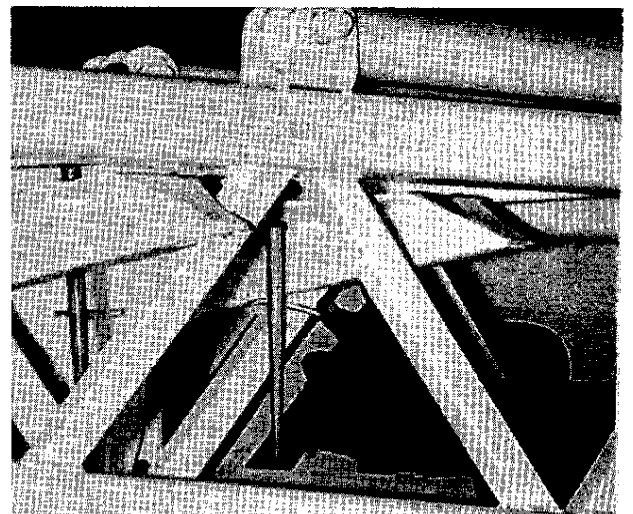

6. Install storage pins in rear storage bracket and secure with retainer pins.

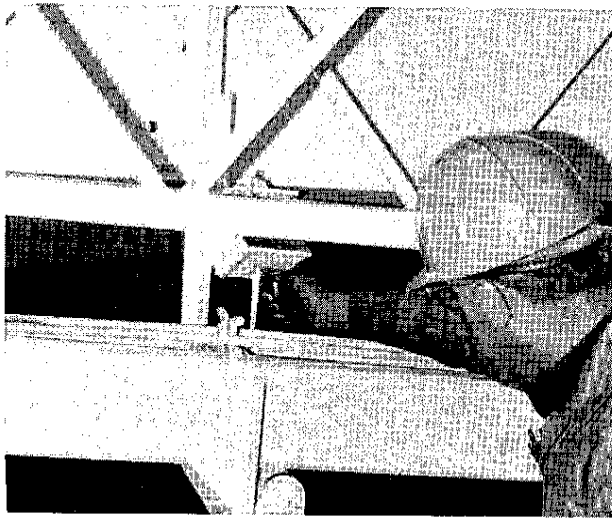

7. With boom lowered for access, install storage pins in front storage bracket and secure with retainer pins.

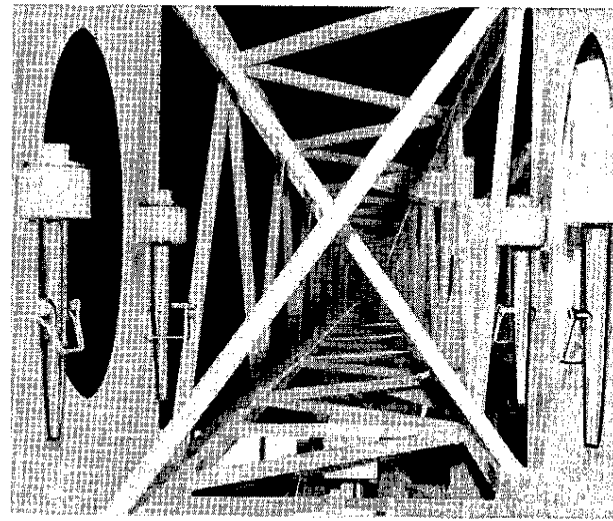

9. Install pivot pins, anchor pins and retainer pins in brackets provided inside base of Side Fly.

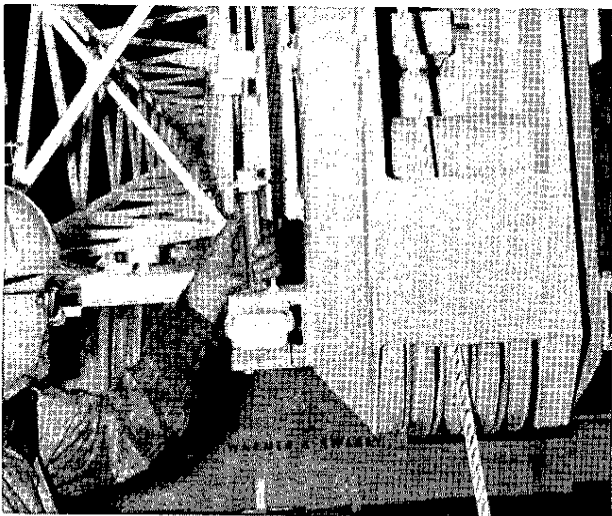

8. Remove retainer pins and pivot pins from boom point and Side Fly.

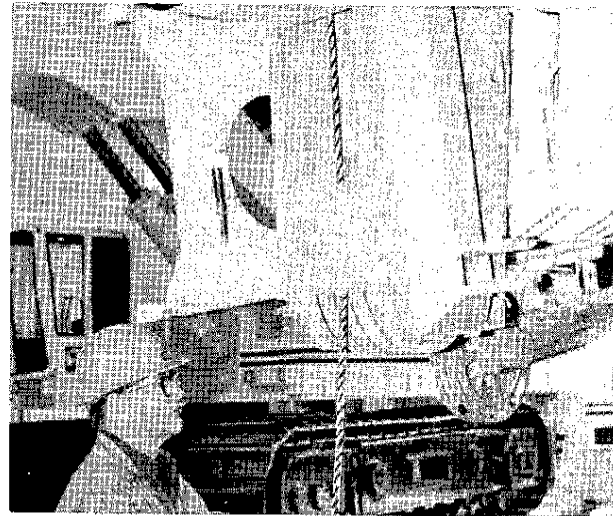

10. Reeve wire rope over boom point as required.

Erecting Side Fly AND Jib

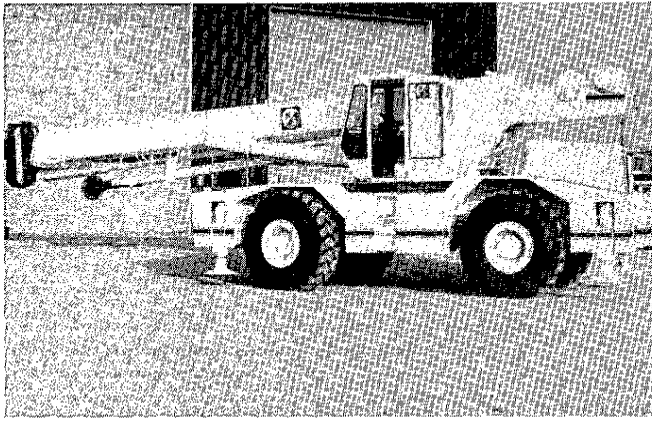

1. With cab facing front, retract and lower boom fully and engage house lock.

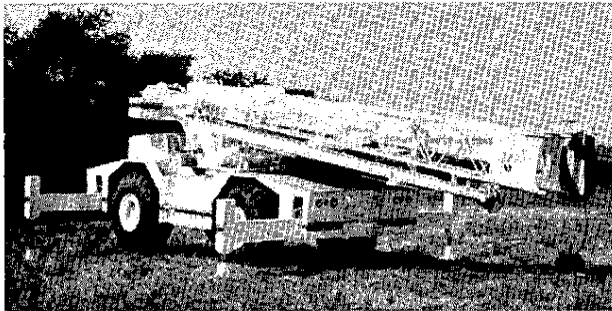

2. Extend outrigger beams and jacks to permit access to boom point. Be sure all jack floats are resting on ground.

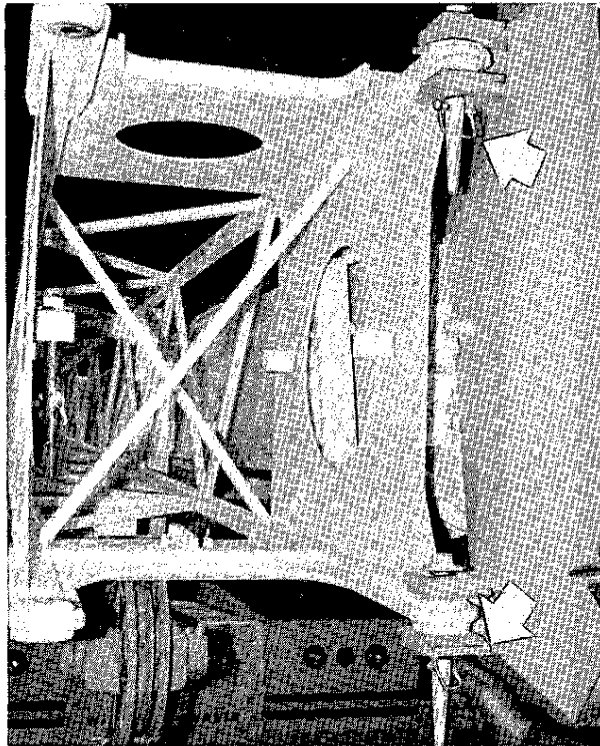

3. Remove pins and retainer pins from storage brackets inside base of Side Fly. Connect Side Fly to boom point with two pivot pins and secure with retainer pins.

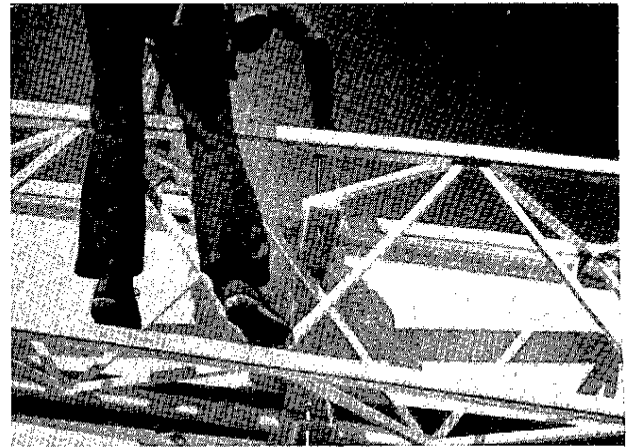

4. Remove Side Fly retainer pins and pins from front storage bracket.



5. Remove retainer pin and jib storage pin from rear storage bracket.

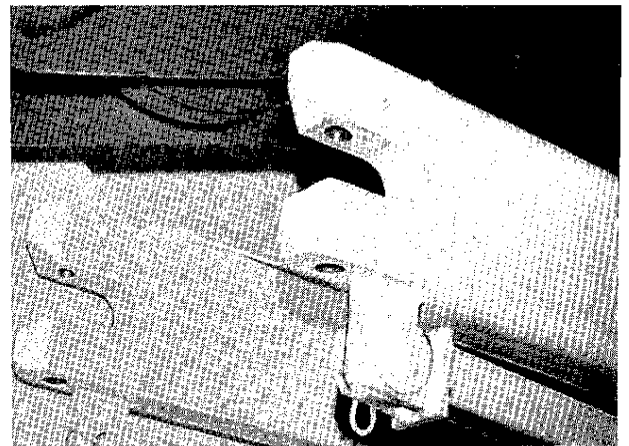

6. Check to be sure spacer blocks and pins ARE NOT INSTALLED in base of jib. Keep these items in storage compartment until needed.

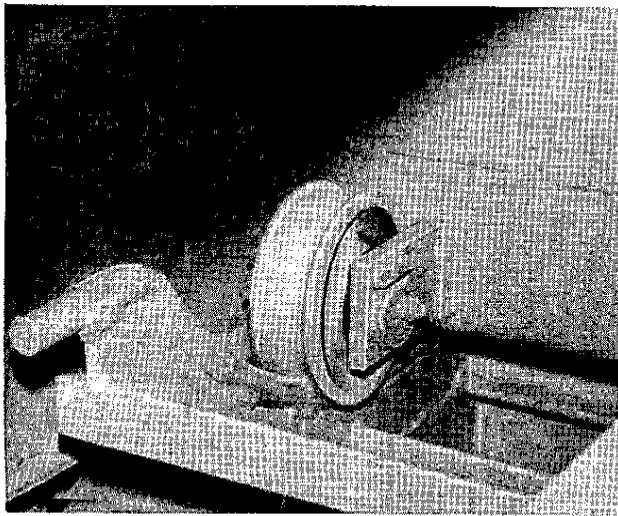

7. Check to be sure rollers at base of jib are properly positioned on roller tracks.

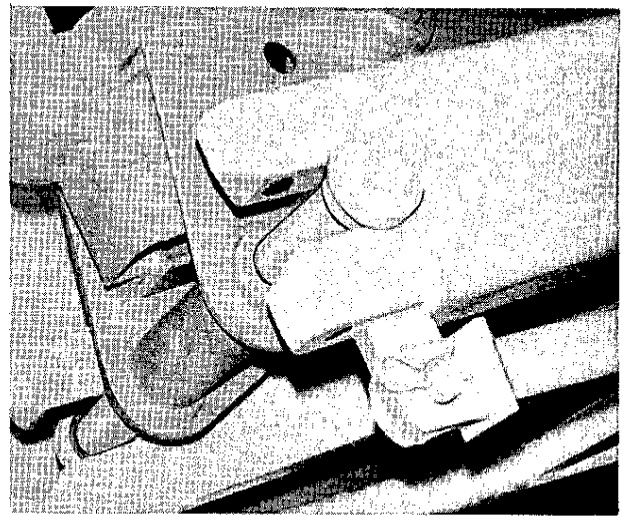

10. Raise boom smoothly until jib rolls into position on shaft at tip of Side Fly (approximately 30° to 40°).

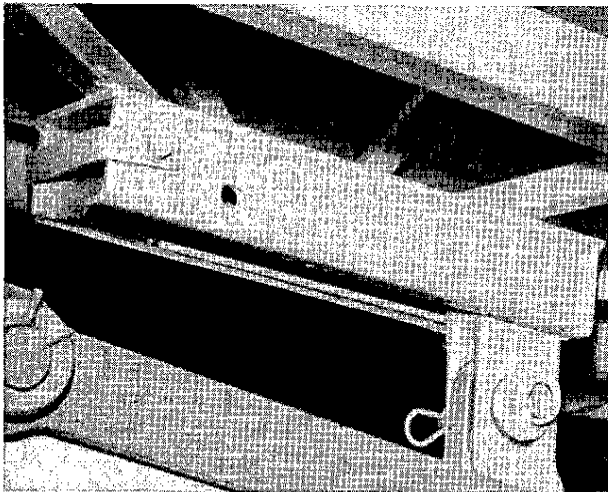

8. Remove retainer pin and storage pin and move roller bracket forward into alignment with jib lug and secure with pin and retainer pin.

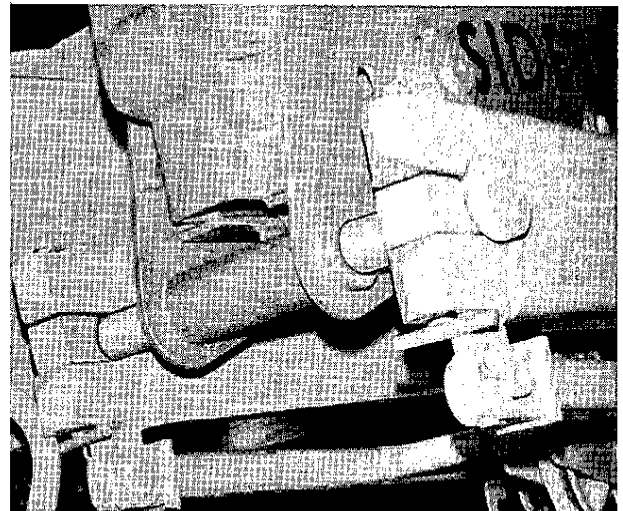

11. Install spacer blocks and secure with pins and retainer pins.

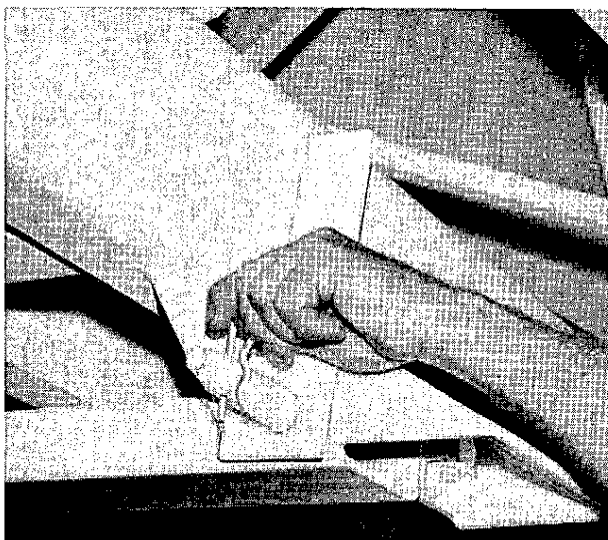

9. Remove jib retainer pin from front storage bracket.

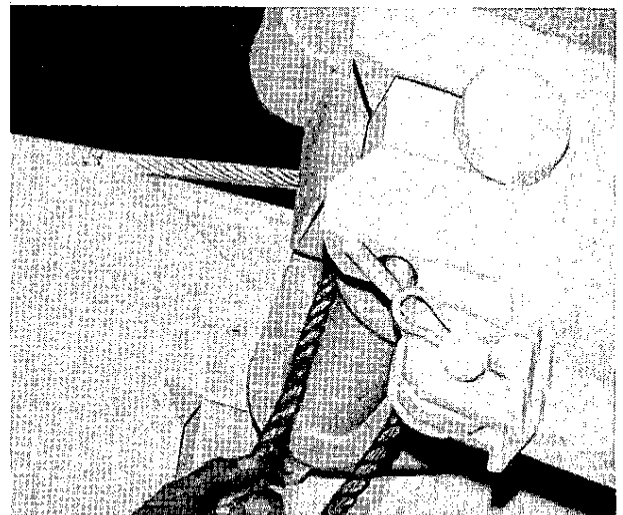

12. Attach a guide rope near tip of Side Fly.

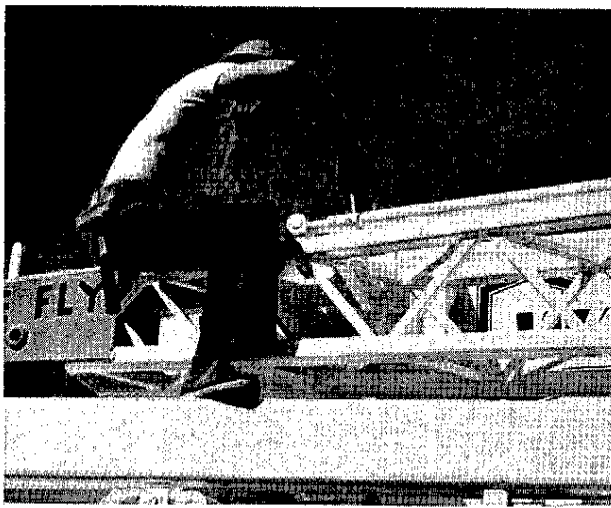

13. Remove retainer pins and pins from rear storage bracket.

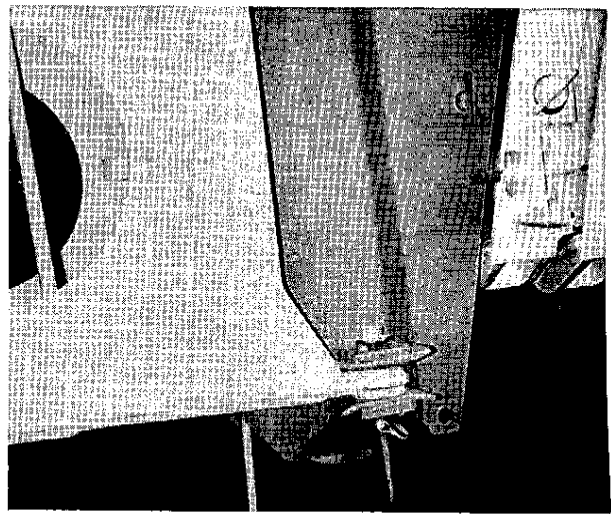

16. Lower boom for access and install anchor pins and retainer pins to secure Side Fly to boom.

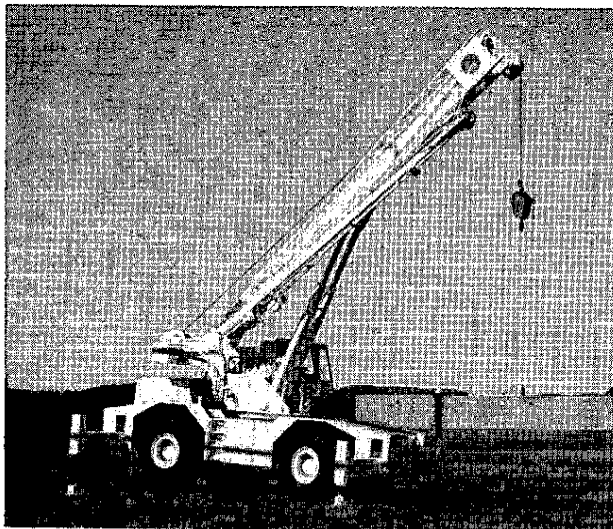

14. Raise boom as necessary to reduce load on Side Fly storage brackets. Pull Side Fly and jib from storage brackets using guide rope.



17. Disconnect main winch line from hook block and remove line from boom point.



15. Lower boom to horizontal position and pull Side Fly into alignment with boom.

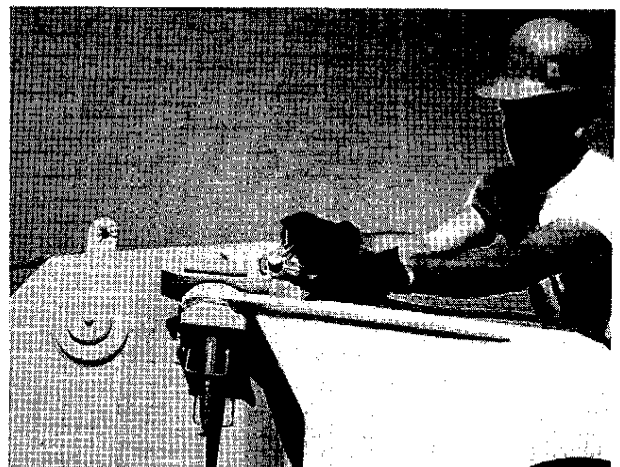

18. Attach rear pendants at boom point.

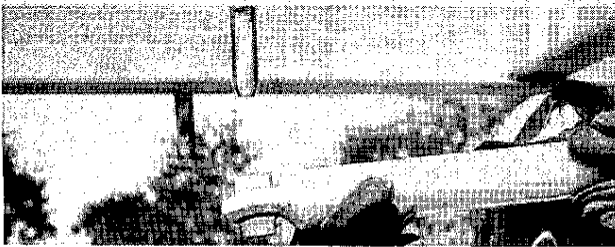
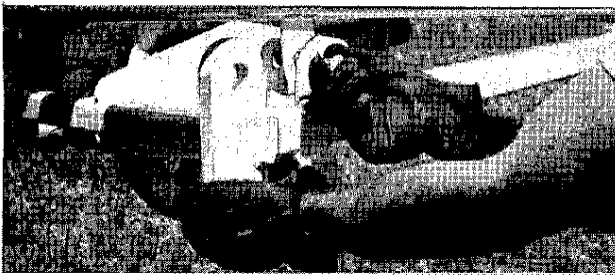

19. Remove retainer pins and storage pins and lower gantry and front support rods.

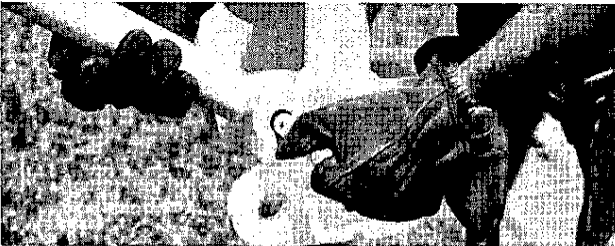

20. Install pins and retainer pins to secure front rods to gantry.

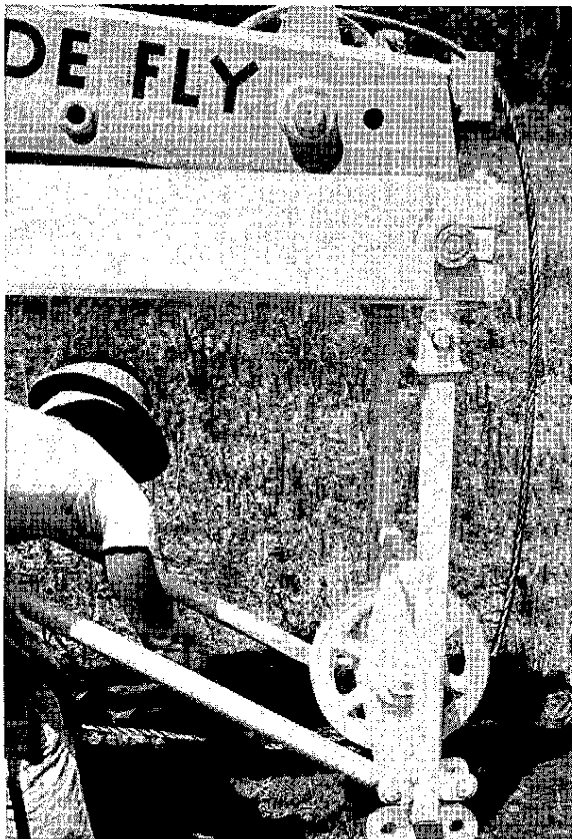

21. Reeve winch line over jib point and through gantry sheave as shown.

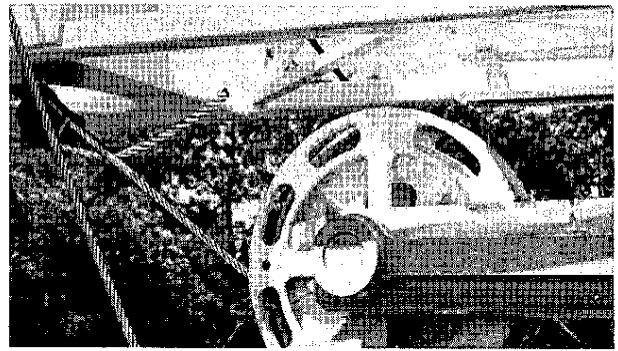

22. Reeve winch line under jib sheave and anchor to lug at base of Side Fly as shown.

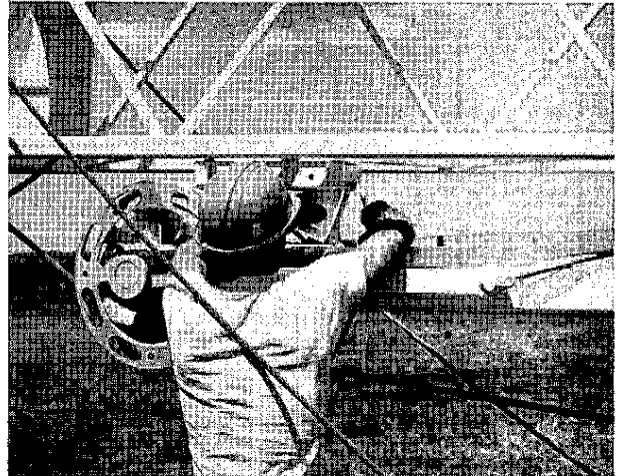

23. Take up winch line just enough to support weight of jib. Remove retainer pin and pin from roller bracket.

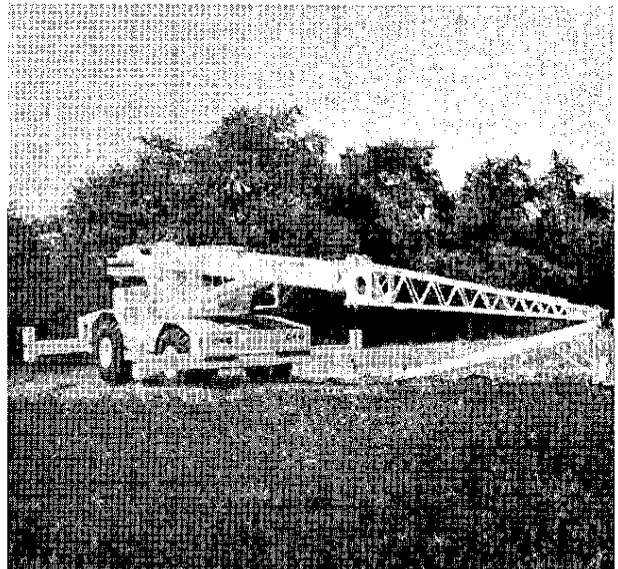

24. Pay out winch line to lower jib to ground. Remove winch line from lug at base of Side Fly.

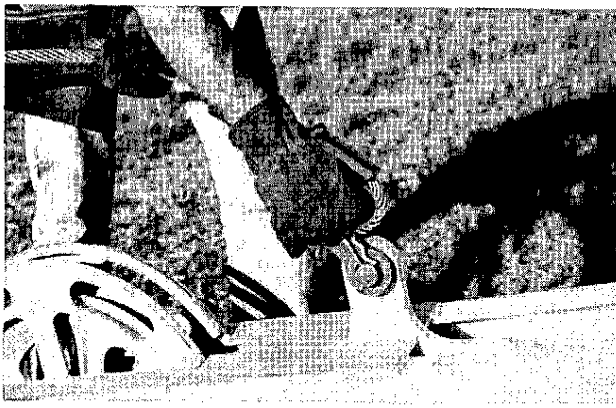

25. Anchor winch line to jib lug as shown.

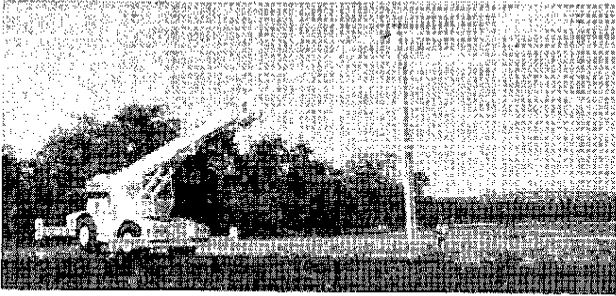

26. Raise boom until jib hangs vertically from boom point and take up slack on winch line.

CAUTION

Practice step 27 by extending jib smoothly in small steps. Serious damage can be caused by extending jib in a jerky, uneven manner.

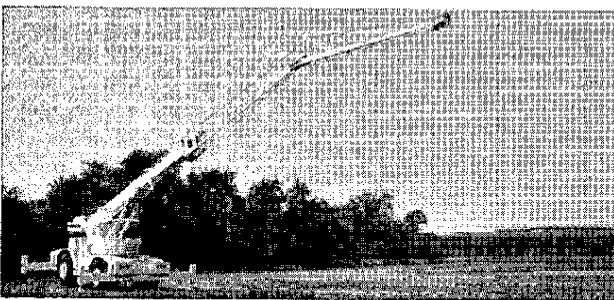
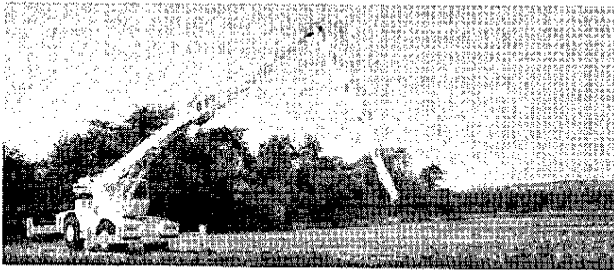

27. While lowering boom slightly to assist winch, take up winch line slowly and smoothly until jib is almost aligned with Side Fly. Jib will continue to raise as the boom is lowered.

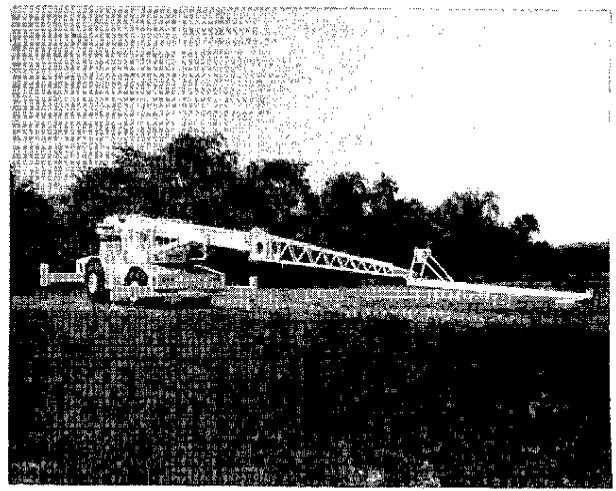

28. Carefully lower boom until jib rests on the ground.

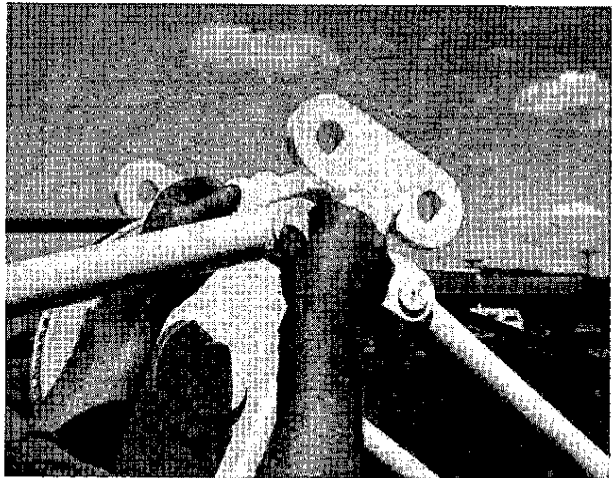

29. Position rear gantry support rods in gantry and secure with pins and retainer pins.

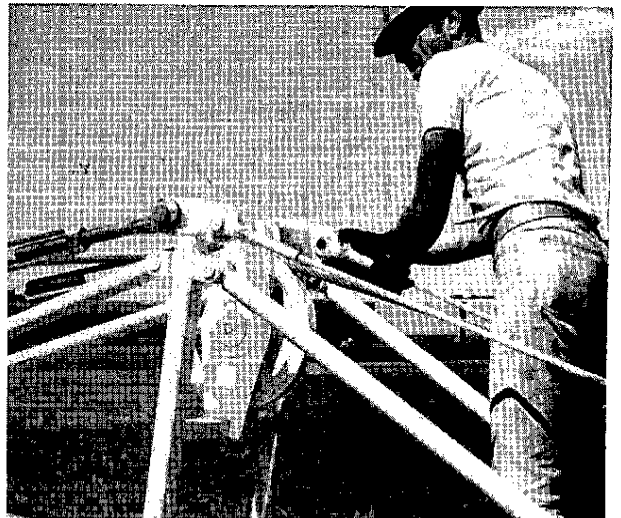

30. Position front and rear pendants on gantry lugs and secure with pins and retainer pins.

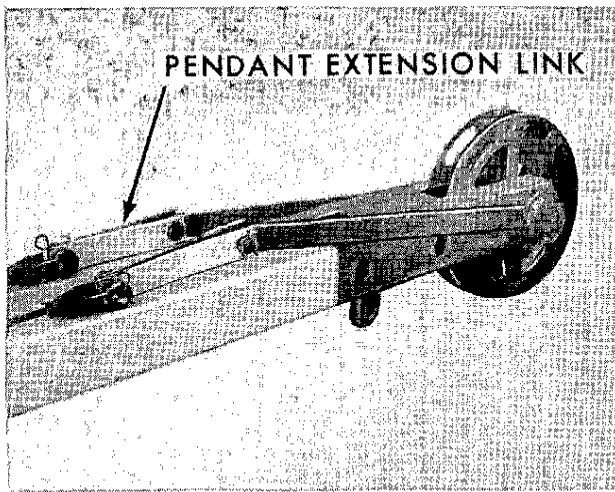

31. Install pendant extension links if gantry is to be offset 30°.

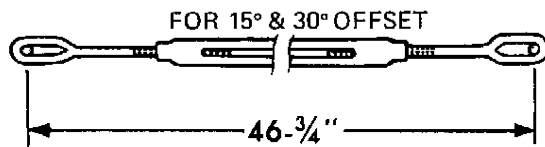
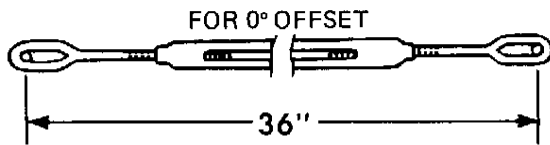

32. Adjust length of turnbuckles for required jib offset. Length between pin centers is 36 inches for 0° offset and 46-3/4 inches for 15° and 30° offset (pendant extension links are required for 30° offset).



33. Check to be sure tension on rear pendants is equal. Tighten turnbuckle on loose pendant if necessary.

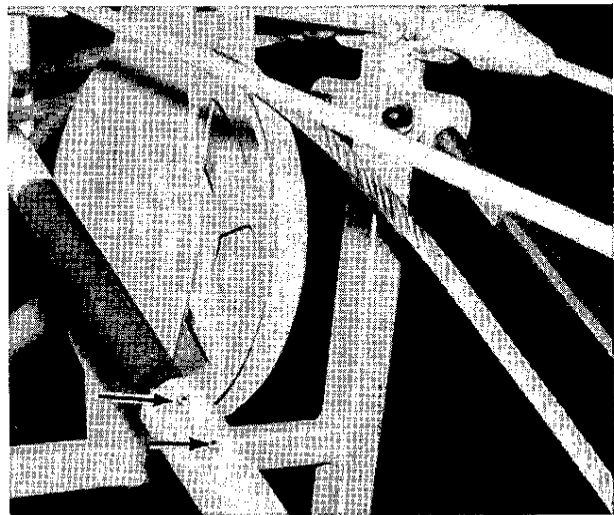

34. Move collars firmly against support rod tubes and tighten set screws.

NOTE: If your crane is equipped with an optional four section main boom, perform steps 35 through 42. If your crane is equipped with the standard three section main boom, perform step 42.

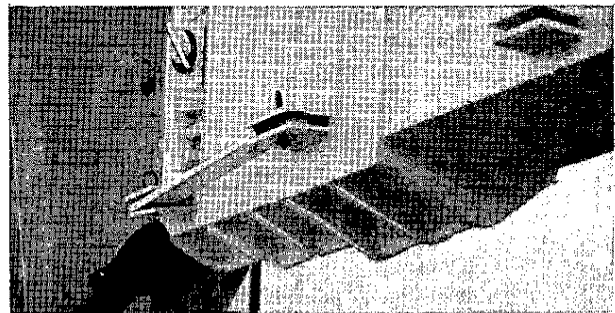

35. Remove retainer pin and pin from rear of holding link. Reposition holding link in front bracket and secure with pin and retainer pin as shown.

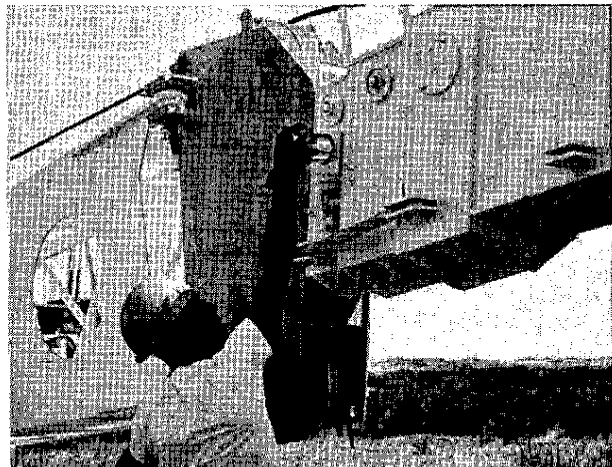

36. Remove retainer pin and cylinder rod anchor pin from boom section number 3.

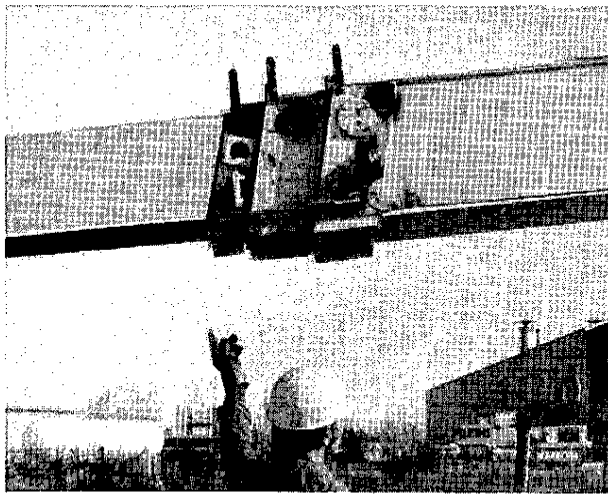

37. Position a man to watch for alignment of holes at front of section no. 3 and at rear of section no. 4 while section no. 4 is being extended. Be sure to pay out enough winch line to prevent two blocking.

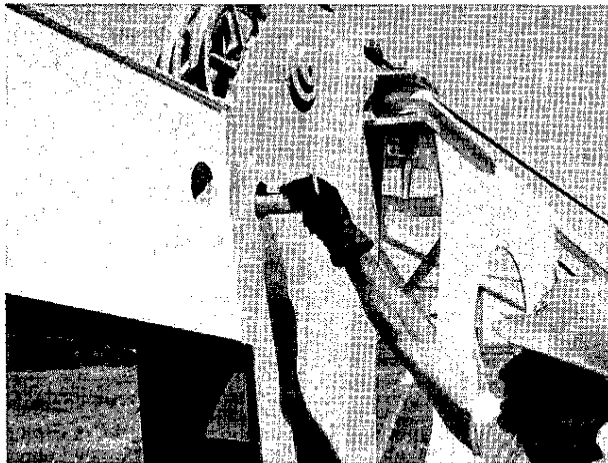

38. Remove retainer pin and cylinder pull pin from boom section no. 4. Place pins in storage compartment.

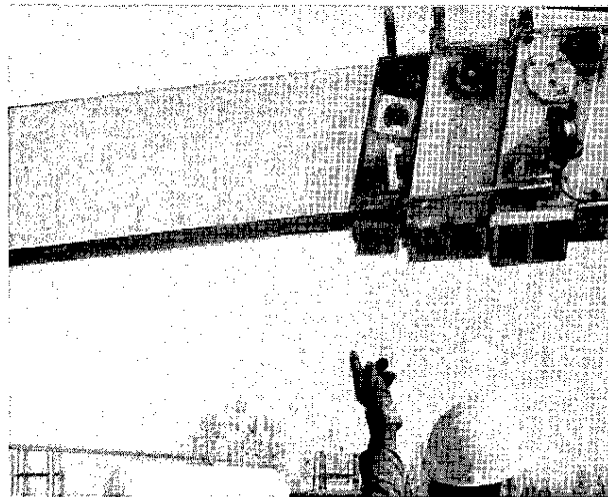

39. With a man positioned to watch for alignment, retract cylinder till hole in rod is aligned with previously aligned holes.

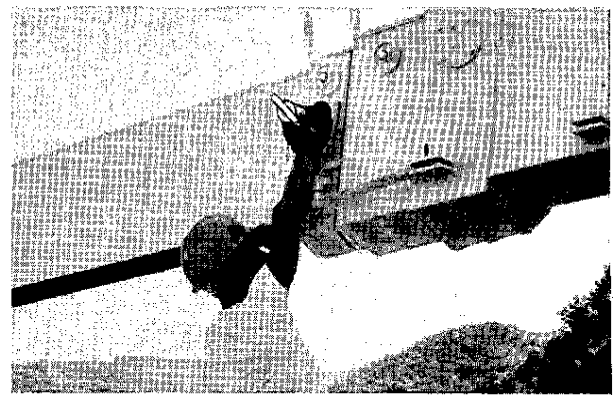

40. Install cylinder rod anchor pin through boom sections 3 and 4 and cylinder rod eye and secure with retainer pin.

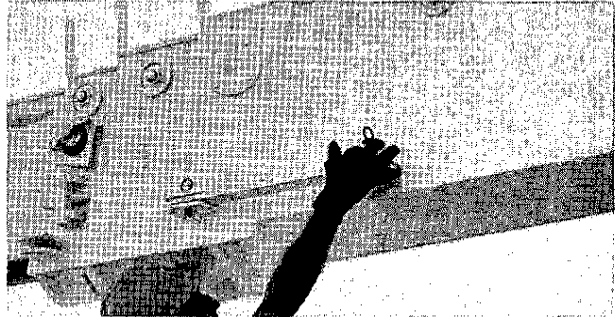

41. Remove retainer pin and pin from front of holding link. Reposition link in middle and rear brackets and secure with pin and retainer pin.

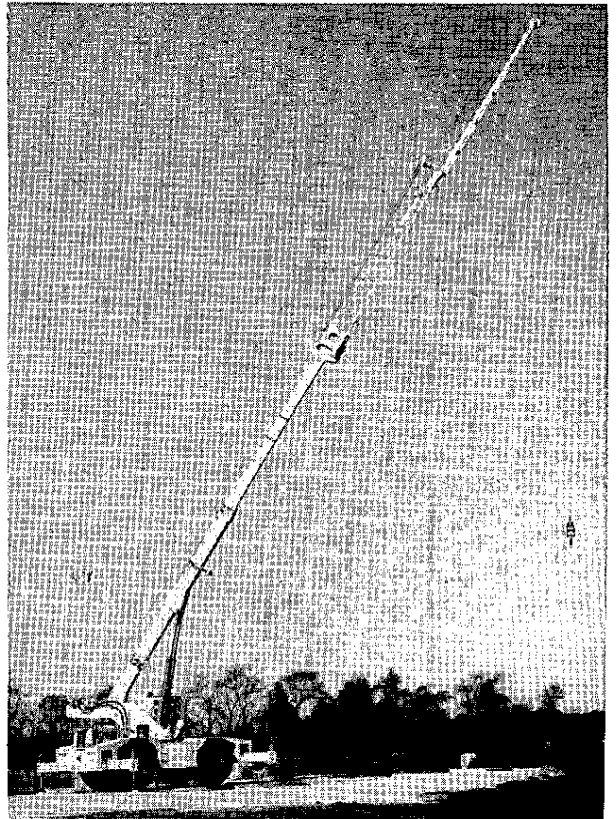

42. Connect Side Fly and jib portions of anti-two block system if so equipped (page 56). Level machine and raise boom to at least 55° before extending boom sections 2 and 3.

Storing Side Fly AND Jib

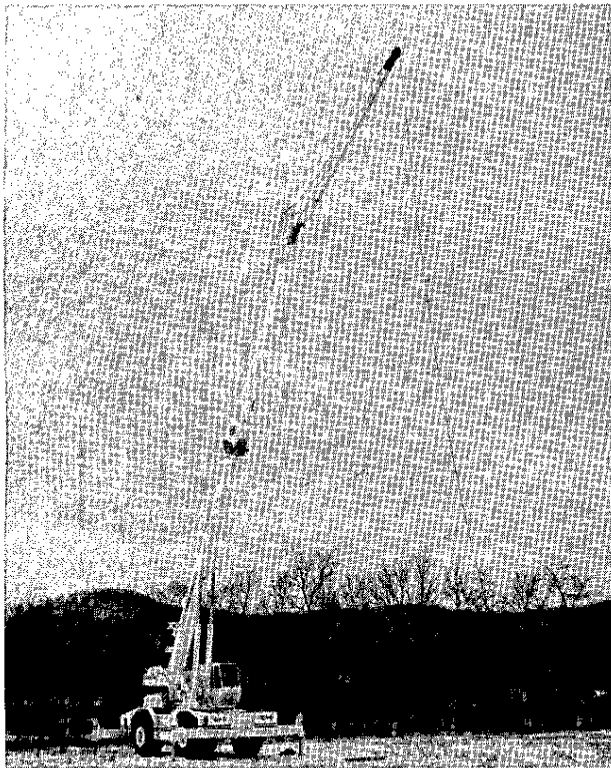

1. With cab facing front, engage house lock and retract boom sections 2 and 3. Remove hook.

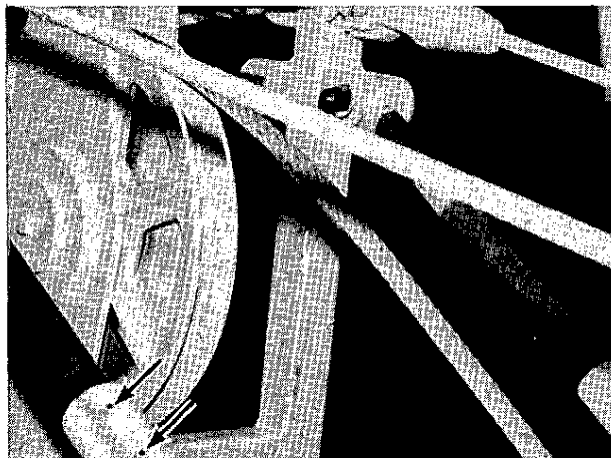

2. Lower boom till jib sheave is a few inches from ground. Loosen set screws in all gantry support rod collars.

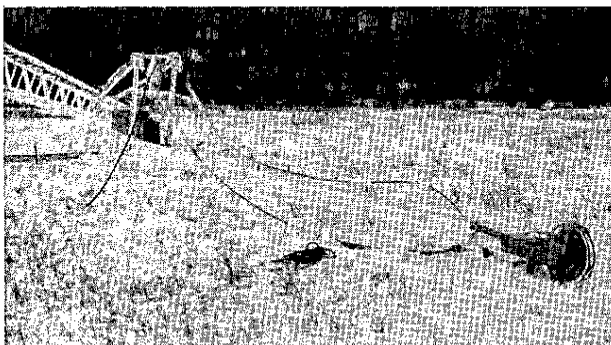

3. Lower boom to position shown. Disconnect Side Fly and jib portions of anti-two block system if so equipped (page 57).

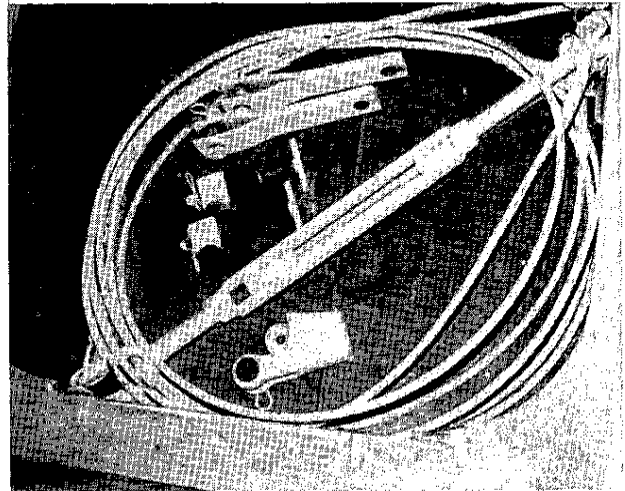

4. Disconnect rear jib pendants, roll and place in storage compartment.

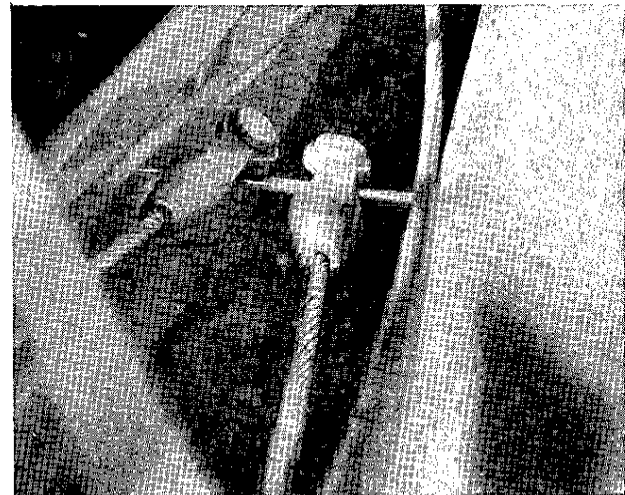

5. Disconnect front jib pendants at rear and fasten in storage position on jib. Remove and store pendant extension links if used.

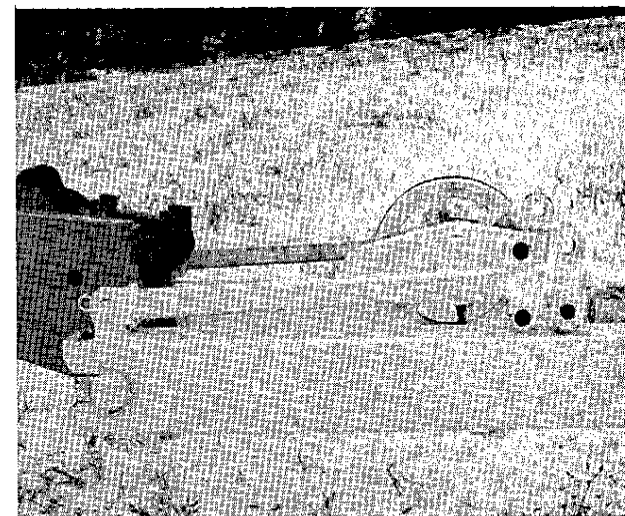

6. Remove winch line from gantry sheave. Unfasten gantry support rods at gantry and lower gantry to rest on jib.

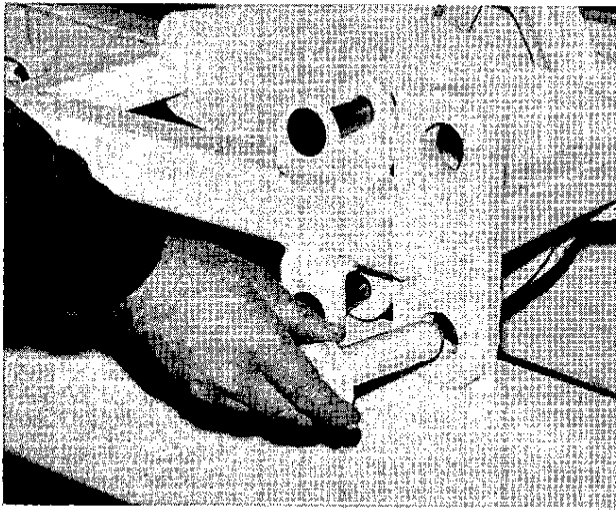

7. Secure upper end of gantry to jib with pins and retainer pins.

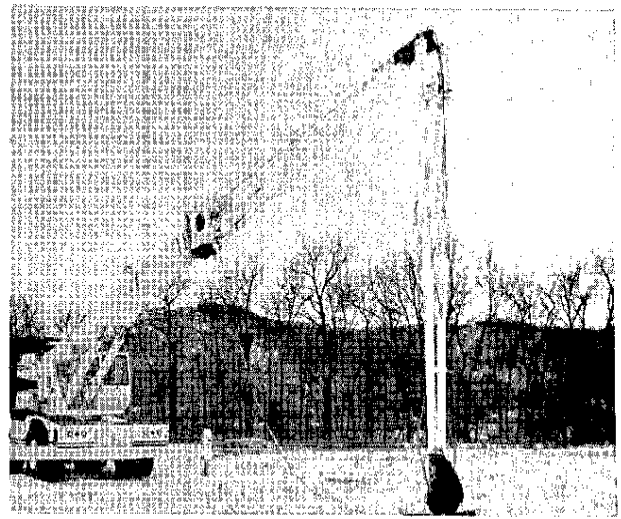

10. Raise boom till jib hangs vertically from Side Fly.

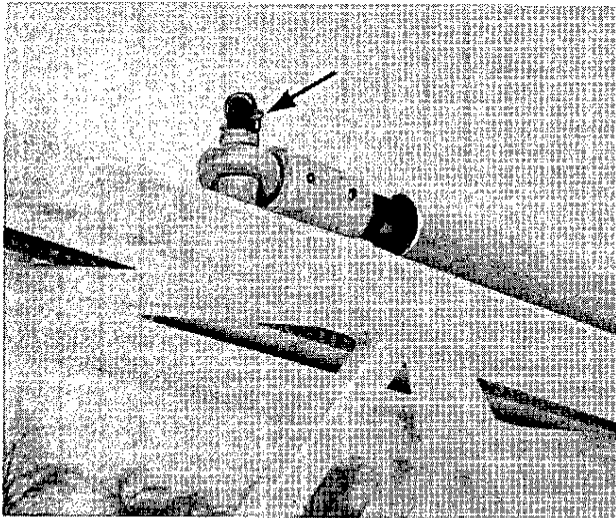

8. Position ends of gantry support rods on storage lugs and secure with retainer pins.

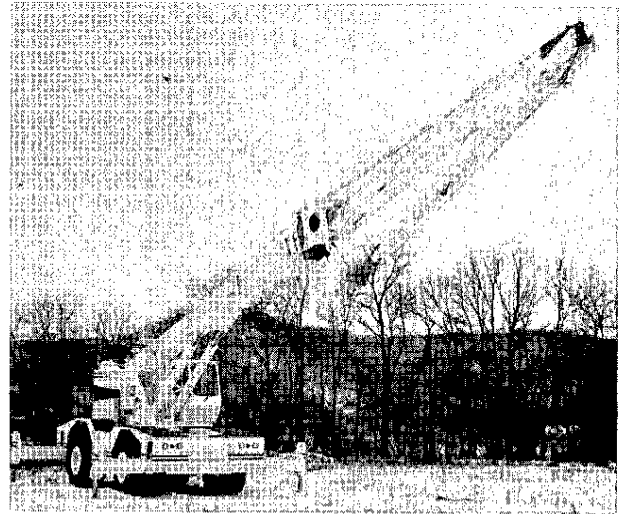

11. Take up on winch line until jib sheave is raised to within one or two feet of Side Fly.

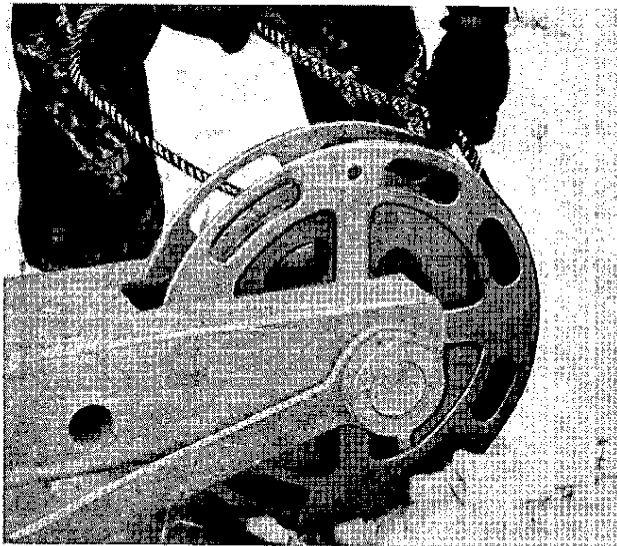

9. Position winch line on gantry sheave and reeve over jib sheave. Fasten winch line to lug at base of Side Fly.

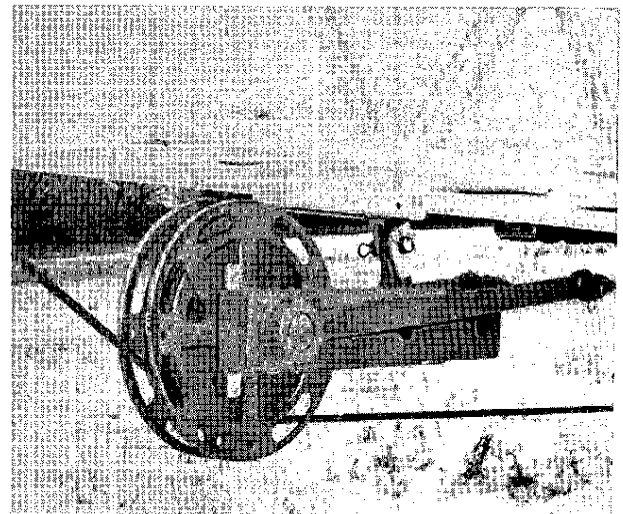

12. Lower boom for access to Side Fly. Carefully take up on winch line till roller bracket can be aligned with jib lug and secure with pin and retainer pin.

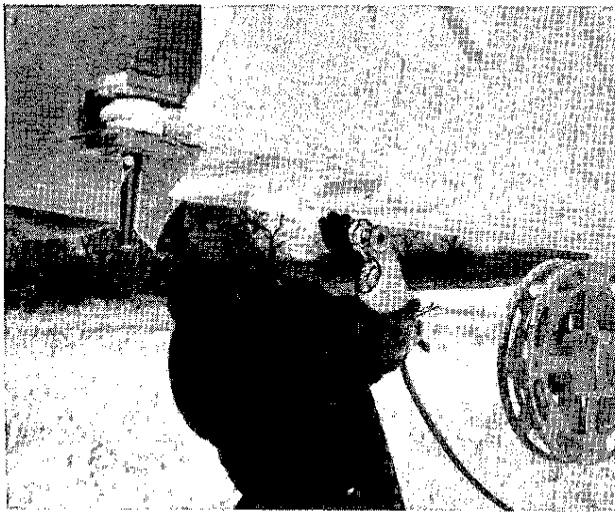

13. Disconnect winch line from lug and remove from Side Fly. Attach guide rope near tip of Side Fly.

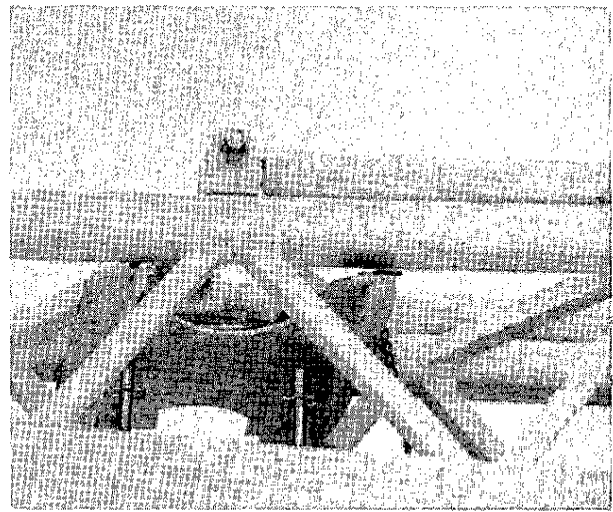

16. Install Side Fly pins and retainer pins in rear storage bracket. Remove guide rope.

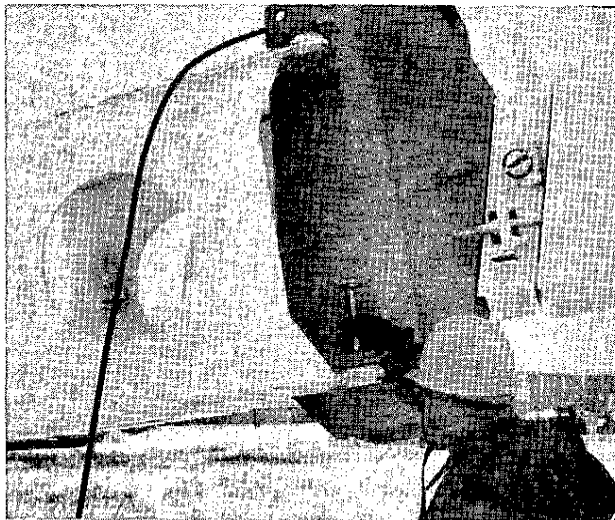

14. Remove retainer pins and anchor pins (2 only) from left side of Side Fly. Store pins inside base of Side Fly.

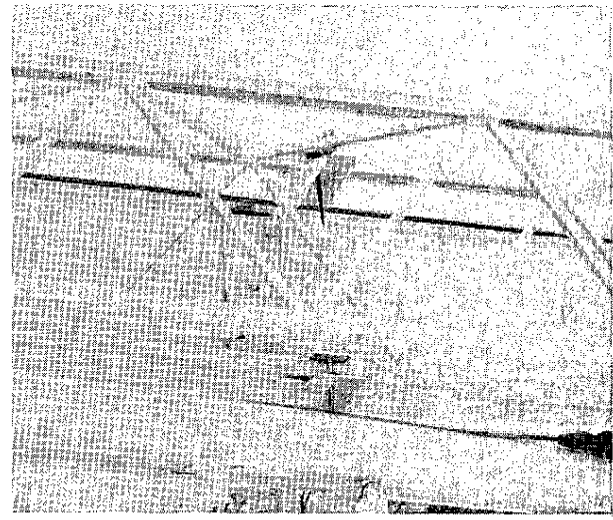

17. Lower boom for access and install Side Fly pins and retainer pins in front storage bracket.

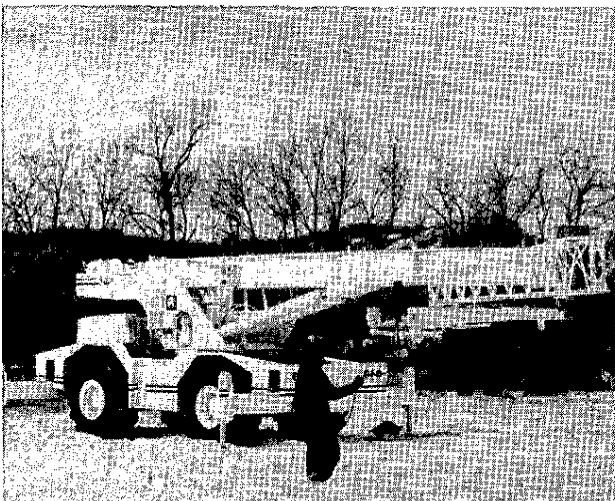

15. Raise boom to horizontal position. Using guide rope, pull Side Fly and jib into position in storage brackets.

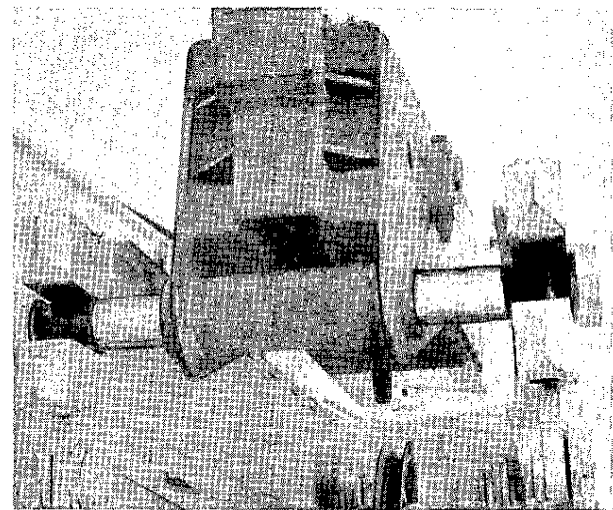

18. Raise boom to approximately 5° above horizontal. Remove retainer pins, pins and spacer blocks from base of jib and place in front storage compartment.

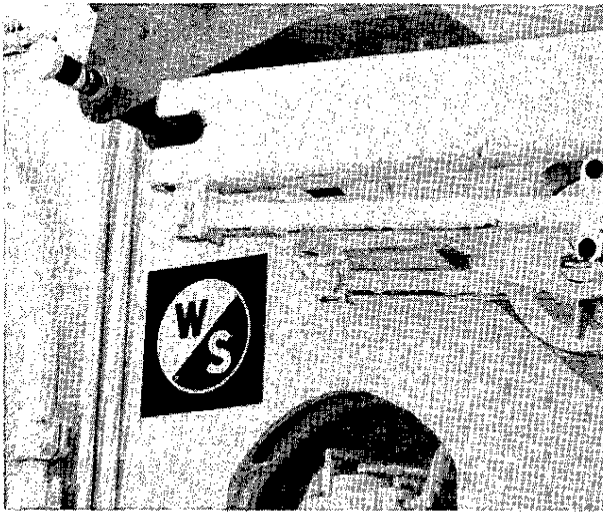

19. Lower boom to allow jib to roll forward into storage position.

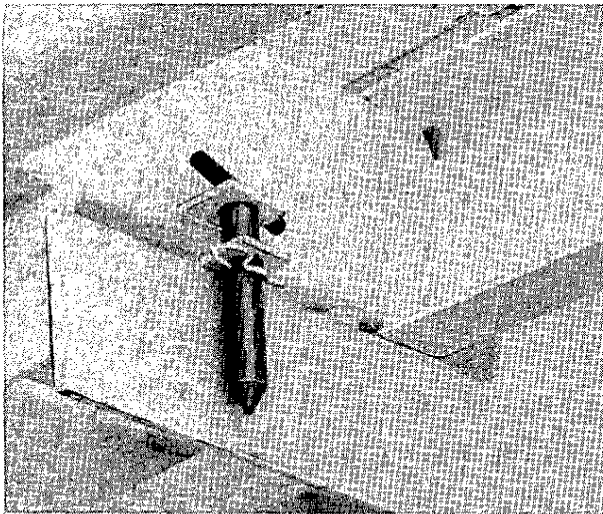

20. Install pin and retainer pin in rear storage bracket.

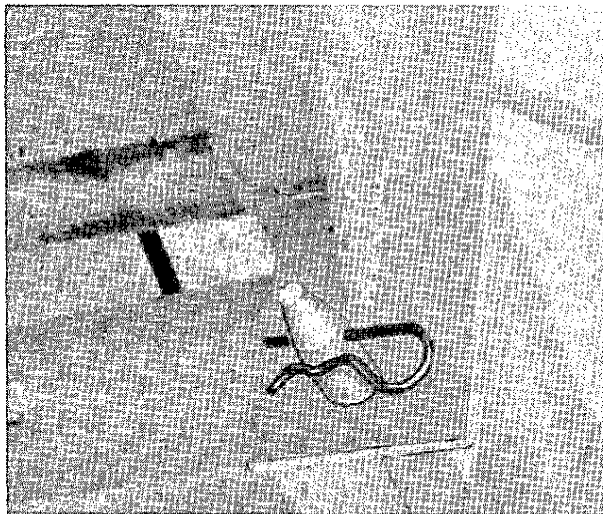

21. Install retainer pin in front storage bracket.

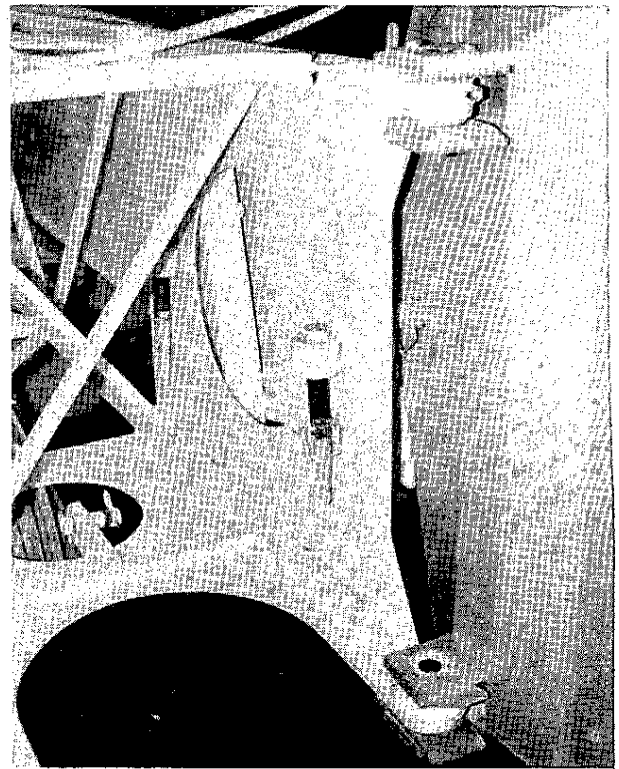

22. Remove retainer pins and pivot pins from right side of Side Fly. Store pins inside base of Side Fly.

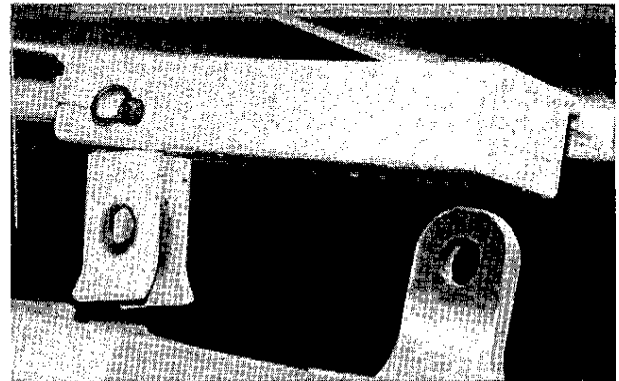

23. Disconnect roller bracket from jib lug and secure in storage position with pin and retainer pin.

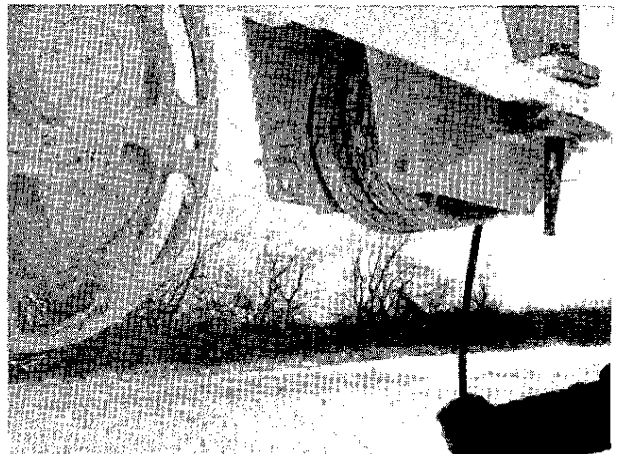

24. Reeve winch line over boom point as required.

REEVING

General

WARNING

Refer to the Load Chart for lifting capacity and reeving specifications.

Determine the weight of the load. This value must include the weight of any handling attachments that may be required, such as a hook block, sling,

etc. Then use the tackle reeving chart on the load chart to determine how many parts of line must be reeved between the boom head and hook block sheaves.

Position the crane as shown and reeve the required parts of line. Plan reeving to leave any unused sheaves toward outside of hook block and boom head.

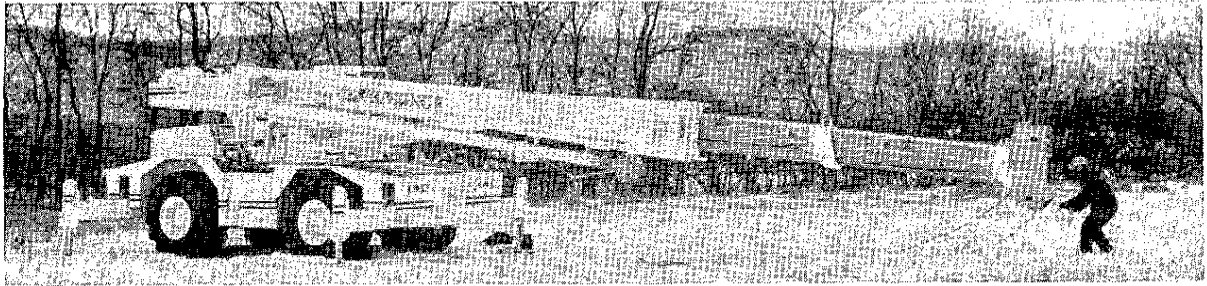

Crane Position for Reeving

Wire Rope Specifications

Main Winch

Size (nominal diameter) 5/8 inch
Strands 6 x 25
Lay Right regular

Material Extra improved plow steel
Minimum Breaking Strength 41,200 lbs
Core Steel
Type Preformed

Auxiliary Winch

Size (nominal diameter) 1/2 inch
Strands 6 x 25
Lay Right regular

Material Extra improved plow steel
Minimum Breaking Strength 26,600 lbs
Core Steel
Type Preformed

Reeving Hook Block

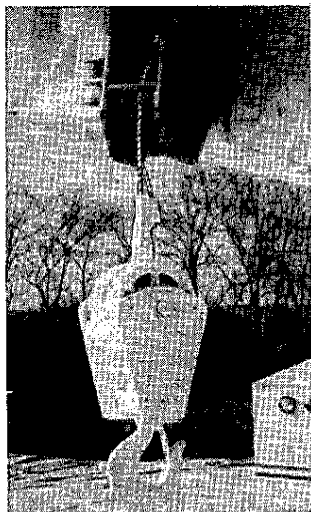

1 PART



2 PART

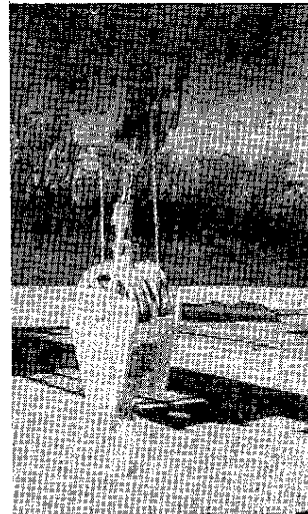

3 PART

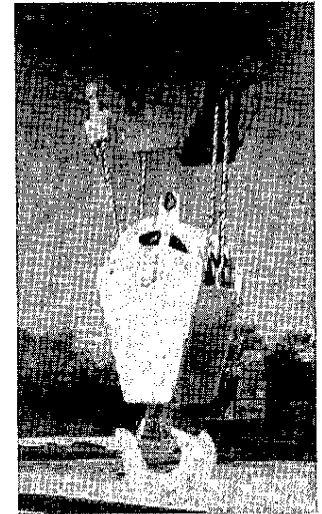

4 PART

Installing Wedge Sockets

Always install live leg (working leg) of wire rope in the straight side of the socket. If installed improperly, the socket tends to kink the rope and weaken it.

Install a cable clamp on dead end of rope as shown as a precaution against rope coming loose from socket.

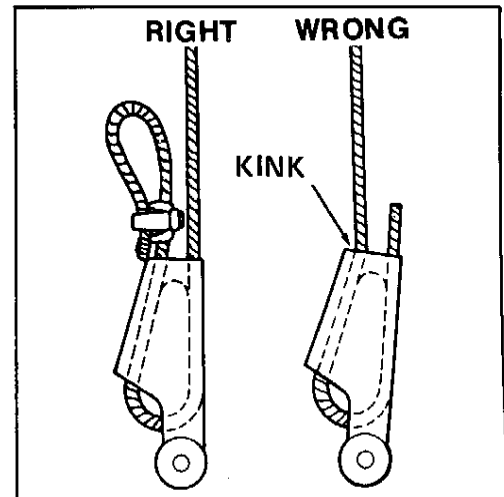

CRANE OPERATION

General

Operation of a hydraulic crane differs from the operation of a conventional crane.

- Always use sufficient engine R.P.M. to prevent stalling.
- Do not determine lifting capacity by the tipping method. Read the Load Chart, which is based on structural limitations and stability, to determine the safe lifting capacity.
- If the SideFly is not required, be sure that the storage pins are in place and that the pivot pins on the boom head are removed before extending the telescoping boom sections.
- Do not allow impatience or fatigue to affect good judgment. **THINK SAFETY.**

WARNING

Do not attempt a lift if the radius, boom angle, boom length and load weight are not within the ratings published by the manufacturer. The working conditions must always be adjusted to agree with the capacity ratings.

WARNING

Perform pick-and-carry work only on a firm, smooth, level surface.

Load Monitor

A load monitoring device of the owner's choice may be installed as optional equipment. If your crane is so equipped, refer to the manufacturer's literature for operating instructions.

Boom Angle Indicator

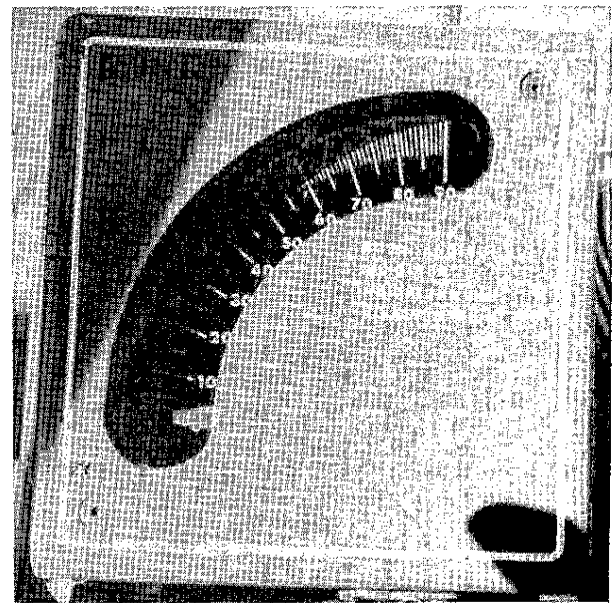

The boom angle indicator is mounted on top of the control console slightly to the right of the operator. The indicator operates electronically to show the number of degrees the boom has been raised from horizontal before loading. Check indicator periodically. It should register approximately -5° with boom lowered fully and approximately $+78^{\circ}$ with boom raised fully.

Calculating Boom Length

Marker stripes on boom section no. 2 are spaced at four foot intervals. Because extension of sections 2 and 3 will always be equal, each exposed stripe indicates an additional 8 feet of extension.

To calculate length, add 8 feet for each exposed marker stripe to length of basic boom (32.5 feet)*

EXAMPLE: Assume that there are two stripes exposed on boom section no. 2.

2 stripes exposed x 8 feet	= 16.0 ft.
Basic Boom (fully retracted)	= 32.5 ft.*
Total boom length = 48.5 ft.	

CAUTION

Be sure to count boom marker stripes accurately when calculating boom length.

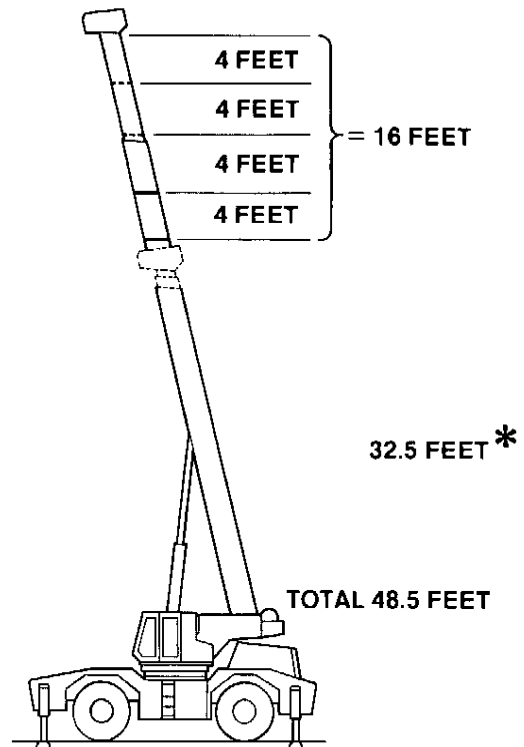

*Actual length is 32.2 ft. for 80 ft. boom and 32.8 ft. for 105 ft. boom.

Areas of Operation Diagrams

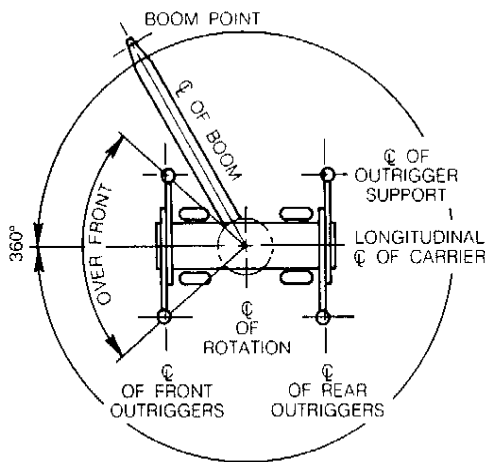

ON OUTRIGGERS*

***On outriggers** capacities are based on outriggers being fully extended to a distance of 21 feet from centerline to centerline of vertical jack cylinders.

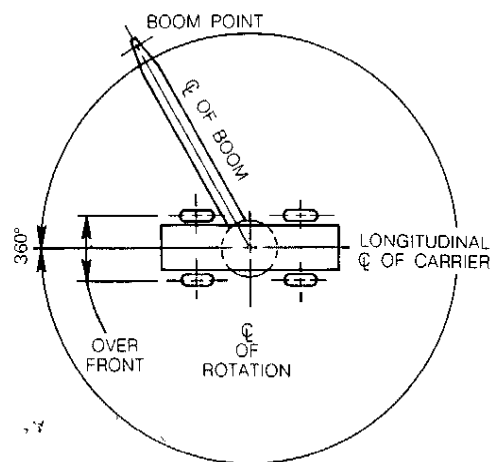

ON RUBBER**

***ON RUBBER** capacities are based on proper tire inflation. Refer to AREAS OF OPERATION diagrams installed in your crane to determine proper tire pressure. Check inflation when tires are cold.

Crane load capacities vary depending on the position of the upperstructure with respect to the carrier, the degree of swing required and whether outriggers will be used.

If necessary, make an unloaded trial run to verify the conditions of the lift and then study the Areas of Operation diagrams to determine which portion of the Load Rating Chart must be used.

Range Diagram

The range diagram (located on cab wall) provides two important kinds of information to help you in planning a lift:

1. It shows boom height for various combinations of boom length and boom angle. For boom lengths and radii not shown, use load rating for next longer boom or radius. Positioning or operating at radii and boom lengths beyond the maximums or minimums shown is not intended or approved.
2. It shows unloaded boom radius (horizontal distance from the axis of rotation, before loading, to center of vertical hoist line or tackle with no load applied). Unloaded boom angles are to be used for reference only. These boom angles must be adjusted to maintain proper load radius while the load is being picked.

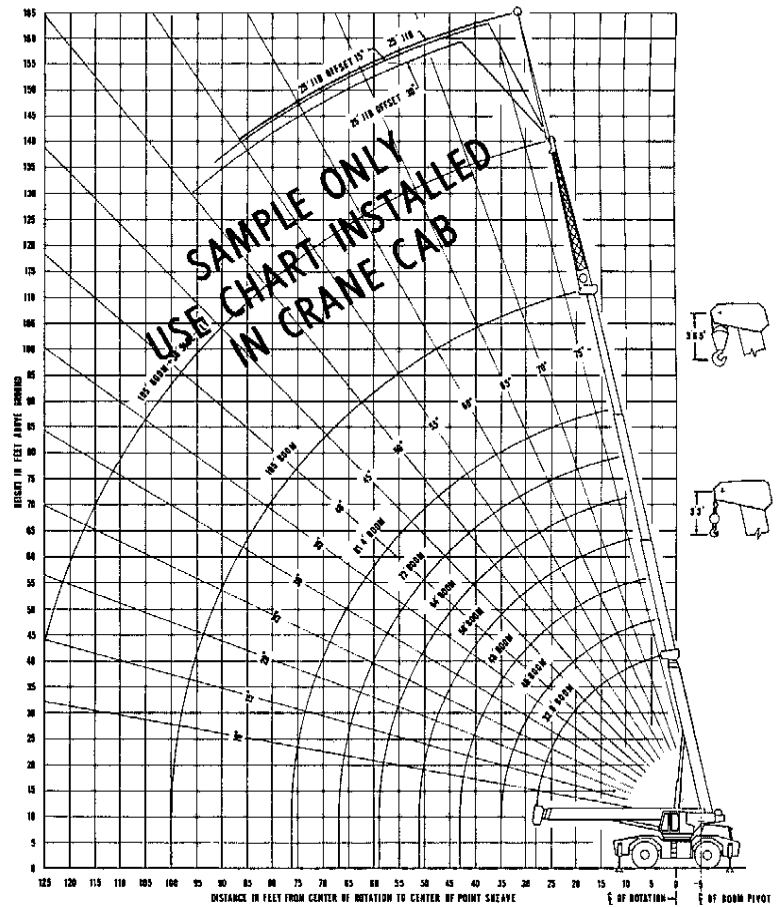

Load Rating Chart

The crane load rating chart (located on cab wall) provides maximum capacity ratings for various boom length and load radius conditions for the following types of lifts:

1. Lifts with machine leveled on fully extended outriggers with 360° swing permitted
2. Lifts with machine leveled on fully extended outriggers and lifting over front only

3. Stationary lifts on rubber over front only
4. Stationary lifts on rubber with 360° swing permitted
5. Pick and carry lifts at creep speed
6. Pick and carry lifts at 5 M.P.H.
7. Lifts using 30 foot Side Fly extension
8. Lifts using 25 foot jib

WEIGHTS OF THE FOLLOWING ITEMS (WHEN USED) MUST BE DEDUCTED FROM MAIN BOOM LOAD RATINGS

Rooster sheave	100 pounds	Side Fly (erected on 105 ft. boom)	1470 pounds*
Hook block, 55 ton	620 pounds	Side Fly (erected on 80 ft. boom)	1530 pounds*
Hook block, 40 ton	500 pounds	Jib (stored)	200 pounds
Hook block, 15 ton	60 pounds	Jib (erected on 105 ft. boom)	1500 pounds**
Headache ball, 5 ton	250 pounds	Jib (erected on 80 ft. boom)	1670 pounds**
Headache ball, 3 ton	200 pounds	Slings, rigging, etc.	as required
Side Fly (stored)	650 pounds		

*Deduct only when lifting over main boom sheave.

**Deduct only when lifting over main boom sheave or Side Fly sheave.

NOTE: Combined weights of erected Side Fly and jib must be deducted when lifting over main boom sheave.

Load Rating Chart (continued)

BE SURE TO USE PROPER SECTION OF LOAD RATING CHART FOR LIFT

Radius of the load is the distance from the axis of upperstructure rotation (before loading) to the center of the vertical hoist line or tackle (with load applied).

Load ratings in these columns are based on main boom being fully extended. Do not exceed these ratings even if main boom is partially or fully retracted.

Weight of Side Fly has been deducted from load ratings in the 105' Boom + 30' Side Fly column.

ON OUTRIGGERS FULLY EXTENDED - 360° (See Areas of Operation chart.)

RADIUS	BOOM LENGTH*												End Section Extended		105' Boom + 30' Side Fly								
	32.8 Feet			40 Feet			48 Feet			56 Feet			64 Feet			72 Feet		81.4 Feet		105 Feet		135 Feet	
	Ang.	Lbs.	Ang.	Lbs.	Ang.	Lbs.	Ang.	Lbs.	Ang.	Lbs.	Ang.	Lbs.	Ang.	Lbs.	Ang.	Lbs.	Ang.	Lbs.	Ang.	Lbs.	Ang.	Lbs.	
10'	83°	80,000	68°	69,500	72°	67,200	75°	59,100															
12'	59°	70,000	85°	66,400	89°	66,000	72°	57,900															
15'	53°	58,300	80°	57,400	66°	54,100	69°	54,000															
20'	40°	48,000	51°	45,900	59°	43,100	64°	39,000	67°	39,000	70°	34,000	72°	30,600									
25'	34°	33,700	42°	33,000	51°	32,800	58°	31,750	62°	30,000	65°	29,400	68°	26,150	73°	18,500							
30'	28°		28°	27,000	44°	27,000	51°	28,750	59°	28,900	61°	24,000	65°	23,000	71°	16,400							
35'					34°	19,760	45°	19,760	51°	19,760	56°	19,760	61°	19,400	68°	15,400	73°	8,500					
40'					20°	15,300	27°	15,300	45°	15,300	51°	15,300	57°	15,300	65°	13,300	71°	7,700					
45'							27°	12,050	39°	12,050	46°	12,050	52°	12,050	62°	11,550	68°	7,000					
50'								11°	9,500	31°	9,500	40°	9,500	48°	9,500	58°	11,000	66°	6,400				
55'									20°	7,810	28°	7,810	34°	7,810	42°	7,810	53°	9,000	64°	6,000			
60'												14°	5,140	31°	5,140	40°	6,570	50°	5,170				
65'														23°	4,250	45°	5,950	56°	4,750				
70'															11°	3,330	40°	5,540	54°	4,400			
75'																	36°	4,750	51°	4,060			
80'																	31°	4,000	48°	3,730			
85'																	25°	3,330	43°	3,400			
90'																		18°	2,740	42°	3,080		
95'																				39°	2,750		
100'																				27°	2,730		
105'																				20°	2,130		
110'																				27°	1,900		
115'																				22°	1,450		
120'																				16°	1,060		
125'																							

EXAMPLE

At a radius of 45' and a boom length of 72' the maximum permissible load is 12,050 pounds.

Load ratings in this chart permit lifts with 360° swing. Refer to areas of operation diagrams.

Load ratings in shaded areas of the load charts are based on crane's hydraulic or structural competence, not on stability. Do not depend on tipping as a warning against over-loading.

Load ratings shown in the unshaded areas of the load charts are based on crane stability, not on hydraulic or structural competence.

ON OUTRIGGERS FULLY EXTENDED - OVER FRONT (See Areas of Operation chart.)

RADIUS	BOOM LENGTH*												End Section Extended		105' Boom + 30' Side Fly								
	32.8 Feet			40 Feet			48 Feet			56 Feet			64 Feet			72 Feet		81.4 Feet		105 Feet		135 Feet	
	Ang.	Lbs.	Ang.	Lbs.	Ang.	Lbs.	Ang.	Lbs.	Ang.	Lbs.	Ang.	Lbs.	Ang.	Lbs.	Ang.	Lbs.	Ang.	Lbs.	Ang.	Lbs.	Ang.	Lbs.	
10'	83°	80,000	68°	69,500	72°	67,200	75°	59,100															
12'	59°	70,000	85°	66,400	89°	66,000	72°	57,900															
15'	53°	58,300	80°	57,400	66°	54,100	69°	54,000															
20'	40°	48,000	51°	45,900	59°	43,100	64°	39,000	67°	39,000	70°	34,000	72°	30,600									
25'	34°	33,700	42°	33,000	51°	32,800	58°	31,750	62°	30,000	65°	29,400	68°	26,150	73°	18,500							
30'	28°		28°	27,000	44°	27,000	51°	28,750	59°	28,900	61°	24,000	65°	23,000	71°	16,400							
35'					34°	22,040	45°	22,040	51°	22,040	56°	20,100	61°	19,400	68°	15,400	73°	8,500					
40'					20°	17,360	27°	17,360	45°	17,360	51°	16,900	57°	16,300	65°	13,300	71°	7,700					
45'							27°	14,250	39°	14,250	46°	14,250	52°	13,550	62°	11,550	68°	7,000					
50'								11°	11,530	31°	11,530	40°	11,660	48°	11,660	59°	11,000	66°	6,400				
55'									20°	9,580	28°	9,580	34°	9,580	43°	9,580	55°	9,000	64°	6,000			
60'												26°	7,360	37°	7,980	52°	7,875	61°	5,620				
65'													14°	6,500	31°	6,500	48°	7,100	59°	5,170			
70'															23°	5,480	45°	6,325	56°	4,750			
75'																11°	4,430	40°	5,820	54°	4,400		
80'																		36°	4,750	51°	4,060		
85'																		31°	4,000	48°	3,730		
90'																		25°	3,330	43°	3,400		
95'																				18°	2,740		
100'																					39°	2,750	
105'																					27°	2,730	
110'																					20°	2,130	
115'																					27°	1,900	
120'																					22°	1,450	
125'																					16°	1,060	

Load ratings in this chart permit lifts over the front only. Refer to areas of operation diagrams.

NOTE: The maximum powered boom load which may be telescoped is limited by hydraulic pressure, boom angle and boom capacity. It is safe to attempt to telescope any load within the stated conditions of the load rating chart.

JIB CAPACITY

Boom Angle	No Offset	15° Offset	30° Offset
77°	4,500	3,700	3,100
70°	4,000	3,600	3,000
65°	3,430	3,180	2,900
60°	3,130	2,930	
55°	2,500	2,450	2,400

Jib load ratings are based on the structural strength of the jib and Side Fly combination with main boom fully extended at a given boom angle and the jib at a given offset. Do not exceed these ratings even if main boom is fully retracted.

The weight of the jib has been deducted from the load ratings in the jib capacity chart.

Minimum boom angle is 55° for work with fully extended main boom, Side Fly and jib combination. Machine tipping can occur rapidly and without warning with jib erected.

ON RUBBER (See Areas of Operation chart)

Maximum allowable boom length is 64 feet.

RADIUS	Stationary Capacity		Pick & Carry Capacity*	
	Over Front	360°	Creep Speed**	5 mph
10'	40,100	33,100	38,800	18,800
12'	35,000	27,600	33,400	15,600
15'	29,300	21,400	27,200	12,000
20'	22,500	13,600	20,100	7,740
25'	18,600	8,130	15,100	4,790
30'	14,100	5,280	11,900	2,960
35'	8,880	3,860	8,880	1,170
40'	6,730	1,710	6,730	
45'	4,970		4,970	
50'	3,340		3,340	
55'	2,310		2,310	

*Mechanical house lock pin must be fully engaged.

**Not more than 200' covered in 30 minutes.

Planning A Lift

1. Determine the weight of the load. Remember, weight of hook block, headache ball, slings, etc. (except hoist rope) must be added as part of the load (see page 49 for list of items and weights). Do not attempt a lift unless you know it is within the load rating of the crane.

NOTE: Crane load capacities are based on freely suspended loads being handled with the crane leveled and standing on a firm supporting surface.

To determine practical working loads, the operator must also consider wind, hazardous surroundings, experience of personnel and proper load handling.

2. Determine best probable crane position for making the lift.
3. Determine probable boom length, load radius and degree of swing required to pick and place

the load.

4. Using Areas of Operation diagrams and Load Rating Chart, check to be sure lift will be within crane's load rating and whether outrigger jacks will be required.
5. Reeve hook block with required parts of line (10,000 lbs maximum per part for 4435 crane and 11,000 lbs maximum per part for 4450 crane).
6. Position crane and set outrigger jacks (if required).
7. Perform an unloaded trial run of lift to verify degree of swing, boom length and load radius.
8. If degree of swing, boom length or load radius must be increased, check Areas of Operation diagrams and Load Rating Chart again to be sure lift is still within crane's load rating.

Swing

House Lock

The house lock lever is located in the right cab wall and operates the house lock pin. The pin is located at the left rear of the upperstructure frame and is designed to engage either of two locking tubes on the crane carrier.

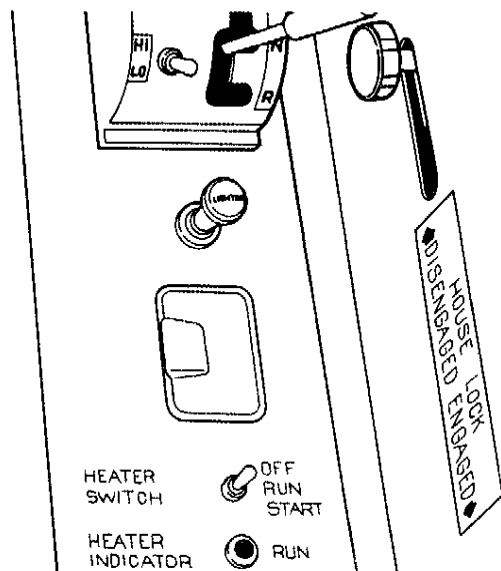

Engaging the lock pin in either of the locking tubes provides a positive mechanical lock which prevents the upperstructure from swinging. **The house lock pin can only engage the locking tubes when the upperstructure is facing directly to the front or directly to the rear with respect to the crane carrier.**

WARNING

If the house lock pin is lowered while the crane is swinging, it could strike one of the locking tubes and cause a loss of control. Always keep house lock control lever in disengaged position (pushed forward) while swinging. Always rest the load before engaging house lock.

The house lock control lever is equipped with a friction lock to hold the lever in the selected position. Turn lever knob counterclockwise to release friction lock. Turn knob clockwise to apply friction lock.

To engage house lock, align front of upperstructure with front or rear of carrier, release friction lock and pull house lock lever to the rear. If lever will not move to the fully engaged position, swing very gently to the left and right while continuing to pull house lock lever. Secure lever in fully engaged position by applying friction lock. Engage swing lock and then check to be sure lock pin is engaged in house lock tube.

To disengage house lock, release friction lock and push control lever forward while swinging gently to left and right to relieve pressure from lock pin. Apply friction lock.

Swing Lock

When engaged, the swing lock functions to apply the swing brake, regardless of the position of the swing brake control handle or the swing control lever.

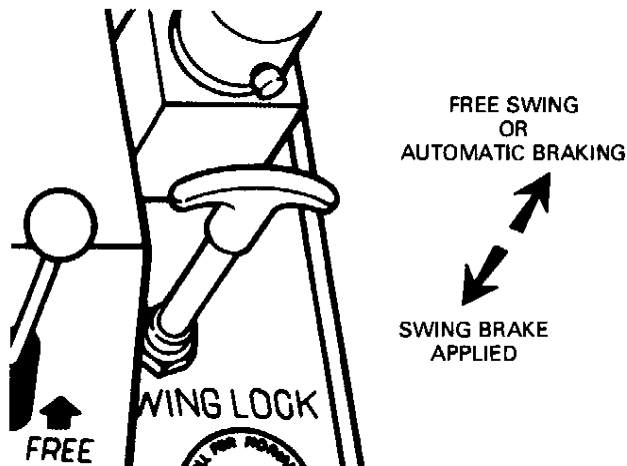

When not engaged, the swing lock permits free swing or automatic swing braking, depending on the position of the swing brake control handle.

Engage the swing lock by depressing the swing lock control handle and disengage by raising the handle.

WARNING

Engage the swing lock only while the upperstructure is stopped. Engaging the swing lock while swinging could cause a dangerous situation and could also cause severe damage.

Swing Brake

The swing brake control functions to permit free swing or cause automatic release and application of the swing brake as the swing control lever is engaged and released.

Free swing permits the upperstructure to drift freely when the swing control lever is not engaged.

When automatic swing braking is selected, the swing brake is applied continuously until the swing control lever is actuated. In this mode, actuation of the swing lever causes the brake to be released

automatically. When the swing control lever is released, the brake will be applied automatically.

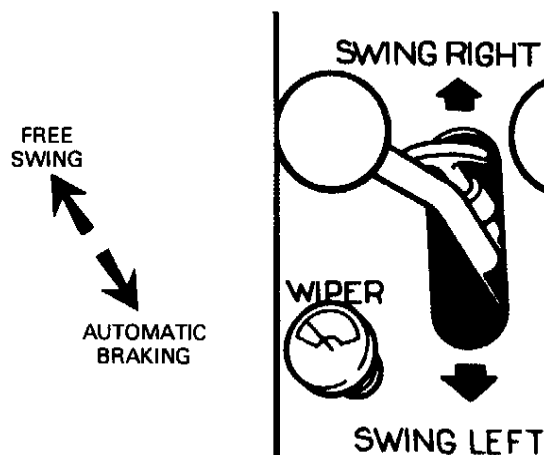

Raise the swing brake control handle (located on the swing lever) for free swing and depress the handle for automatic braking.

WARNING

Use automatic braking only for low speed swing work. When using automatic braking, meter swing control to a slow gentle stop. Releasing the swing lever abruptly would cause an immediate, full application of the swing brake. Such braking would cause a dangerous situation and could cause severe damage.

Swing Right & Left

PRECAUTIONS

- Before swinging, check to be sure house lock and swing lock are disengaged and that swing brake is positioned properly for the type of work to be done.
- Always check to be sure of adequate clearance for boom and counterweight.
- **Be sure boom is raised above horizontal before swinging over rear of carrier.**

Push swing control lever forward to swing right and pull lever to rear to swing left. **Engage and disengage lever gently and smoothly when starting and stopping the swing.**

WARNING

Always engage house lock and/or swing lock before leaving the cab.

Boom Hoist

Normal Hoisting & Lowering

Two interconnected controls are provided for raising and lowering the boom; a control lever is mounted on the control console and a control pedal is mounted on the floor to the left of the brake pedal.

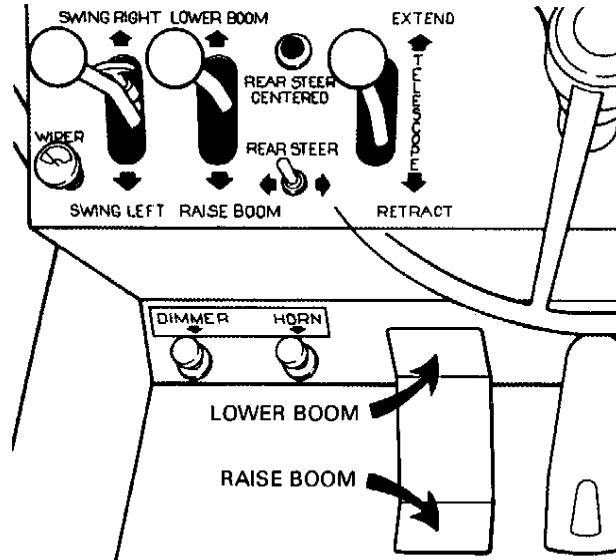

Raise the boom by pulling the boom control lever back or by depressing the rear of the control pedal with your heel. Lower the boom by pushing the control lever forward or by depressing the front of the control pedal with your toe.

When the control lever or pedal is released, counterbalance valves cause a hydraulic lock within the boom hoist cylinders causing the boom to remain in the desired position.

Boom hoisting and lowering speed is controlled by the amount of control lever or pedal actuation. Slight control actuation provides slow boom movement.

Boom Hoist Speed-Up

The speed of a hydraulic function is dependent on the amount of hydraulic flow to the function.

Flow from one pump is always available for raising or lowering the boom. If the boom hoist control lever is moved in the RAISE direction for more than approximately 3/4 of its possible travel, flow from a second pump may be directed to the boom hoist cylinders.

The additional flow is diverted from the boom telescoping function and from the main winch speed-up function. If either of these functions is being used, there will be no additional flow (additional speed) for the boom hoist cylinders.

Telescoping Boom

Telescoping boom sections of the standard crane are identified as Section No. 1 (base section) Section No. 2 (middle section) and Section No. 3 (boom point section). When the optional fourth section is furnished, it becomes the boom point section.

Boom sections 2 and 3 are extended and retracted hydraulically and section no. 4 (when furnished) must be extended and retracted manually (see pages 28, 29 and 30).

Equal extension or retraction of sections 2 and 3 occurs simultaneously when the control lever is actuated.

Boom telescope speed is controlled by the amount of control lever actuation. Slight control actuation provides slow extension or retraction.

WARNING
Check to be sure Side Fly storage pins are in place and that Side Fly pivot pins are removed before extending telescoping boom.

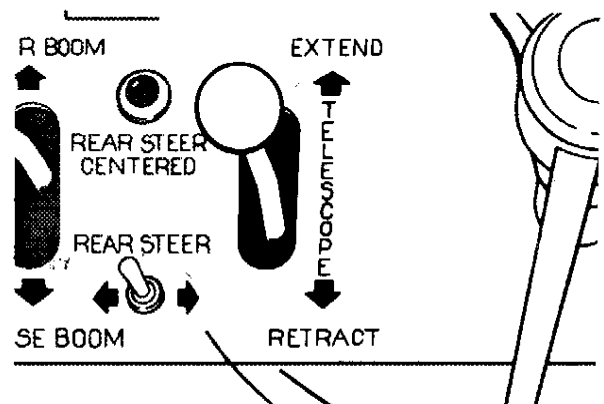

Extend boom sections by pushing lever forward and retract boom sections by pulling lever back. Marker stripes on section 2 are spaced at four foot intervals.

Main Winch

The standard main winch is hydraulically operated and is furnished with an automatic brake and a single winch speed.

Optional equipment which may be furnished with the winch includes a second winch speed and/or a controlled free fall function. Check the control levers provided to determine whether either of these options have been furnished with your unit.

Winch speed depends on the amount of hydraulic flow to the winch motor. Because rapid winching is important to efficient operation, the winch circuit has been designed to receive hydraulic flow from the pumps supplying three other crane functions.

Flow from the boom hoist circuit is available to the main winch when the boom hoist is not being used.

Flow from the accessory (optional auxiliary winch) circuit is available to the main winch when the auxiliary winch is not being used.

Flow from the telescoping boom circuit is available to the main winch when the boom is not telescoping. This flow is supplied to the main winch only when the winch control lever has been actuated more than approximately 3/4 of its possible travel.

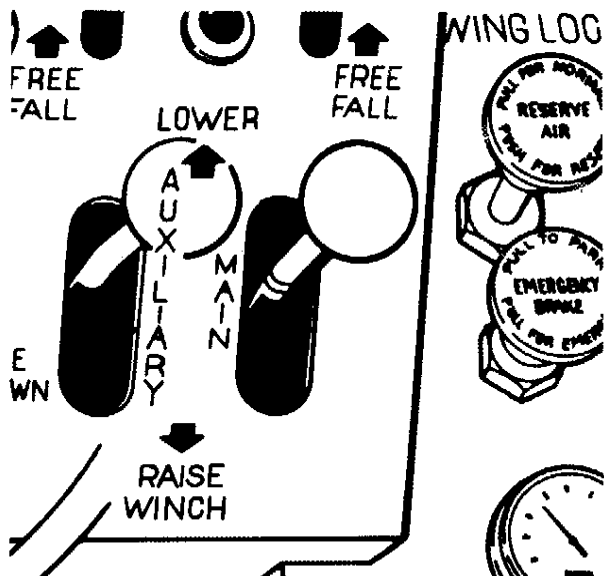

CAUTION

When making a lift, accelerate and decelerate the load slowly and smoothly.

Raise the main winch line by pulling the MAIN WINCH control lever back and lower the line by pushing the lever forward.

Winch braking is automatic. When the control lever is actuated far enough to move the load, the brake will be released. When the lever is returned to its neutral position, the brake will be applied.

Before making a complete lift, test the holding power of the winch brake by suspending the load an inch or two from the ground or rest position.

Two Speed Winch

The optional two speed winch permits selection of HI or LO gear to suit job conditions. HI gear provides increased line speed at a reduced line pull. LO gear provides increased line pull at reduced line speed.

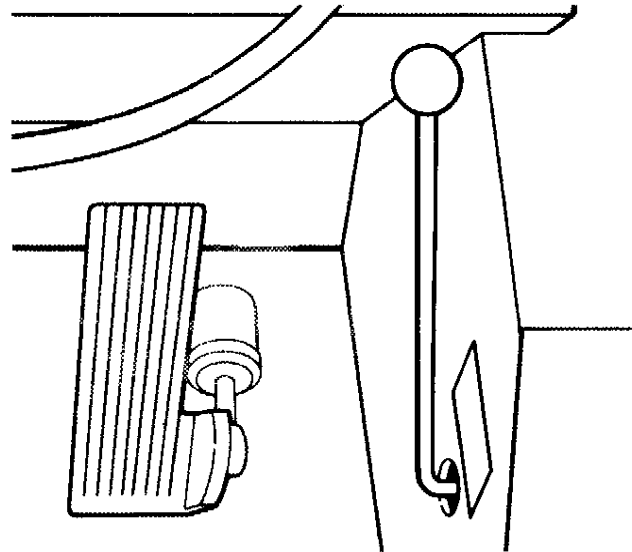

To shift winch from one gear to the other, STOP THE WINCH COMPLETELY and move MAIN WINCH SPEED control lever fully to the other position.

CAUTION

Attempting to shift winch speeds while the winch is rotating, or operating the winch with gear incompletely engaged can damage the winch.

Controlled Free Fall

Controlled free fall enables the operator to lower light loads more rapidly than is possible by powered lowering.

WARNING

Free fall loads may not exceed the smallest of the following as shown on load rating chart:

- 1/3 of rated line pull
- 1/3 of limit for boom length and radius
- 1/3 of jib and/or Side Fly limit

In effect, the free fall function causes a precisely controlled release of the winch brake. The farther the free fall control lever is actuated, the greater the degree of brake release.

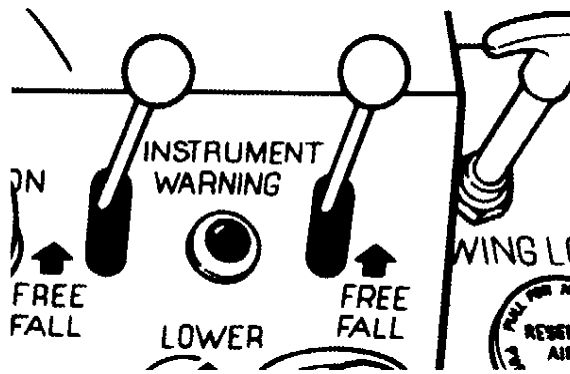

Actuate the free fall function by pushing the **FREE FALL** control lever forward **slowly and smoothly**. Disengage free fall by returning the lever to its neutral position with the same slow, smooth motion.

CAUTION

Always move the free fall control lever slowly and smoothly. Sudden actuation of the lever can cause the load to be lowered at an uneven speed.

Test free fall by raising load about three feet from the ground and lowering load in stages using the free fall function.

Auxiliary Winch

The auxiliary winch may be furnished as optional equipment. It includes an automatic brake and a single speed.

Optional equipment available for use with the auxiliary winch includes only a free fall function. Check the control levers to determine whether your unit is so equipped. Instructions covering operation of the free fall function are included under the Main Winch heading.

Flow from one pump is always available to the auxiliary winch. Operation of other circuits will not affect the flow available to the auxiliary winch.

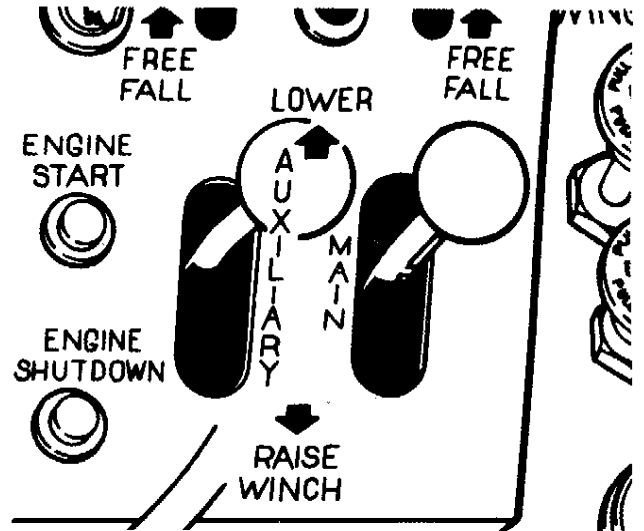

CAUTION

When making a lift, accelerate and decelerate the load slowly and smoothly.

Raise the auxiliary winch line by pulling the **AUXILIARY WINCH** control lever back and lower the line by pushing the lever forward.

Winch braking is automatic. When the control lever is actuated far enough to move the load, the brake will be released. When the lever is returned to its neutral position, the brake will be applied.

CAUTION

Before making a complete lift, test the holding power of the winch brake by suspending the load an inch or two from the ground or rest position.

Drum Rotation Indicator

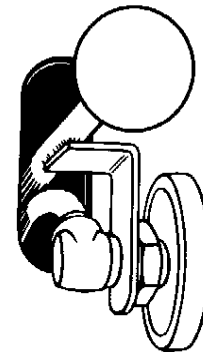

The optional drum rotation indicator revolves to show winch rotation. Rotation of the indicator is proportional to winch drum speed.

ANTI-TWO BLOCK SYSTEM

General

Two blocking occurs when the hook block, headache ball or other rigging contacts the sheaves of the main boom head, Side Fly or jib. Such contact can damage the crane and cause the load to fall.

The anti-two block system (optional equipment) provides a buzzer and a warning light to warn the operator that two blocking is about to occur. The operator is warned when there is still approximately two feet of travel before two blocking will occur.

The system can also be equipped to automatically stop winch up, boom down and boom extend movements at the same time the warning buzzer and light are activated.

Check the sheave heads of the main boom, Side Fly and jib to determine the extent to which your crane has been equipped. A limit switch, switch activator weight and a connecting chain are provided at each sheave head to be monitored by the system.

Warning Buzzer & Light

The warning light for the anti-two block system is located on the control console between the carrier leveling indicator and the boom angle indicator.

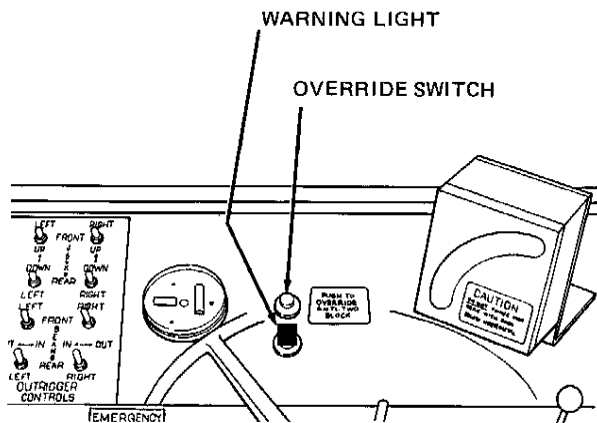

The warning signals will be activated by any one of three conditions:

- When ignition switch is turned on but engine is not running (this indicates that warning signals are working properly)
- When hook block, headache ball or other rigging contacts the limit switch activator weight (removing strain from limit switch allows switch to close and activate warning signals)
- When fuse for anti-two block system electrical circuitry has blown

WARNING

Return control levers to neutral position immediately when warning signals are activated. Study the situation and then reposition as required.

Automatic Stop

Check control linkage beneath cab. If some control rods are joined to rear bell cranks with small hydraulic cylinders, your unit is equipped with the automatic stop feature.

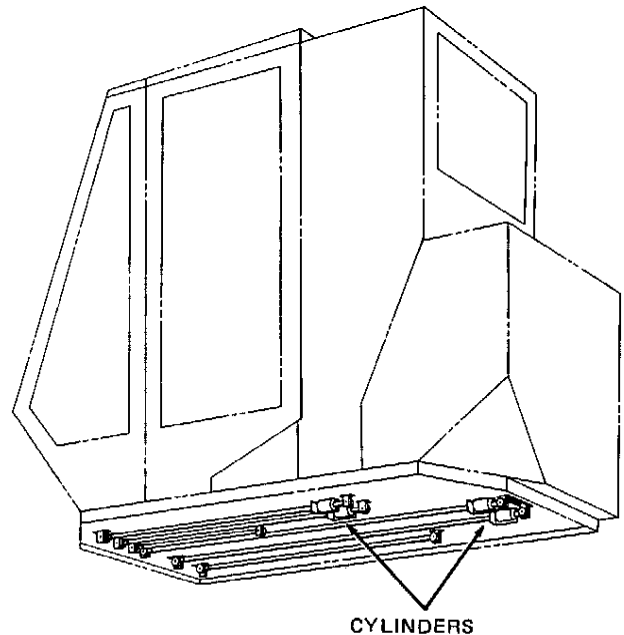

When so equipped, winch up, boom down and boom extension movements stop automatically when the warning light and buzzer are activated. Winch down, boom up and boom retract movements are not affected by the automatic stop feature.

Override Switch

The anti-two block override switch is located on the control console between the carrier leveling indicator and the boom angle indicator. When the override switch button is depressed, the warning signals and the automatic stop feature are deactivated. The anti-two block system will be reactivated immediately when the override switch button is released.

Connecting System for Use

To connect the main boom portion of the system, reeve wire rope through activator weight as shown. When using multiple parts of line, activator weight must be on dead ended leg of line.

To connect Side Fly portion of system, perform the following procedure:

1. With Side Fly erected, connect main boom portion of system.
2. Reeve wire rope from Side Fly sheave through activator weight as shown.
3. Connect electrical circuit at base of Side Fly as shown. Turn plug clockwise in socket to lock.

To connect jib portion of system, perform the following procedure:

1. With Side Fly and jib erected, connect main boom and Side Fly portions of the system.

NOTE: Wire rope from main boom or Side Fly sheave must be used for jib.

2. Reeve wire rope from jib sheave through activator weights as shown.

NOTE: Activator weights on Side Fly and main boom must be suspended on their chains to permit jib portion of system to operate.

3. Connect electrical circuit at base of jib as shown. Turn plug clockwise in socket to lock.

Disconnecting System

CAUTION

Disconnect electrical circuitry at two disconnect points before beginning to store Side Fly and jib.

NOTE: There are no connect/disconnect points in the system electrical circuitry to the main boom head.

To disconnect jib and Side Fly portions of the system, perform the following procedure:

1. Disconnect electrical circuitry at base of jib and Side Fly and store plugs as shown.
2. Remove activator weights from wire rope at jib and Side Fly as required. Store weights as shown.

Anti-Two Block System Components

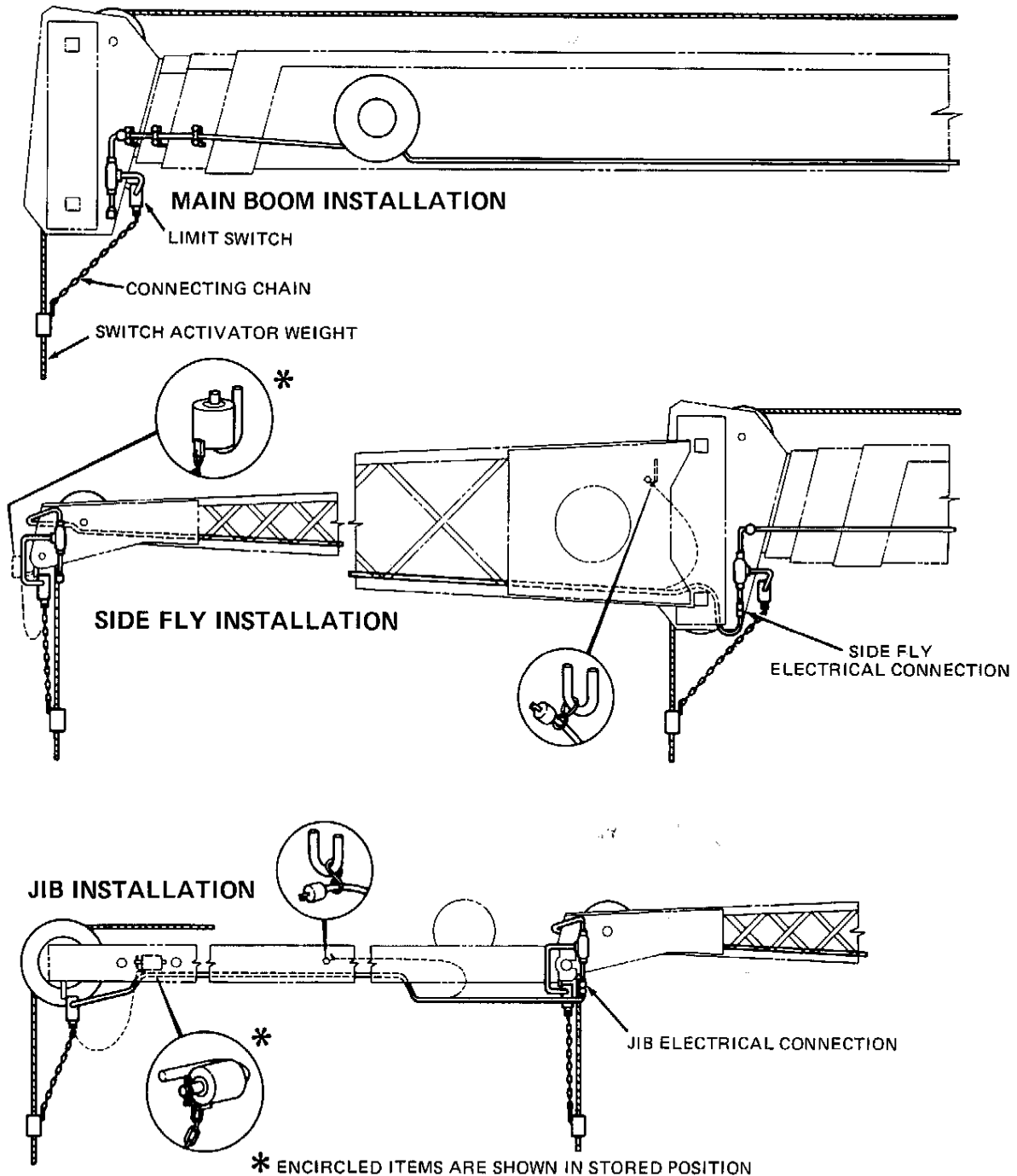

Lubrication & Maintenance Diagram

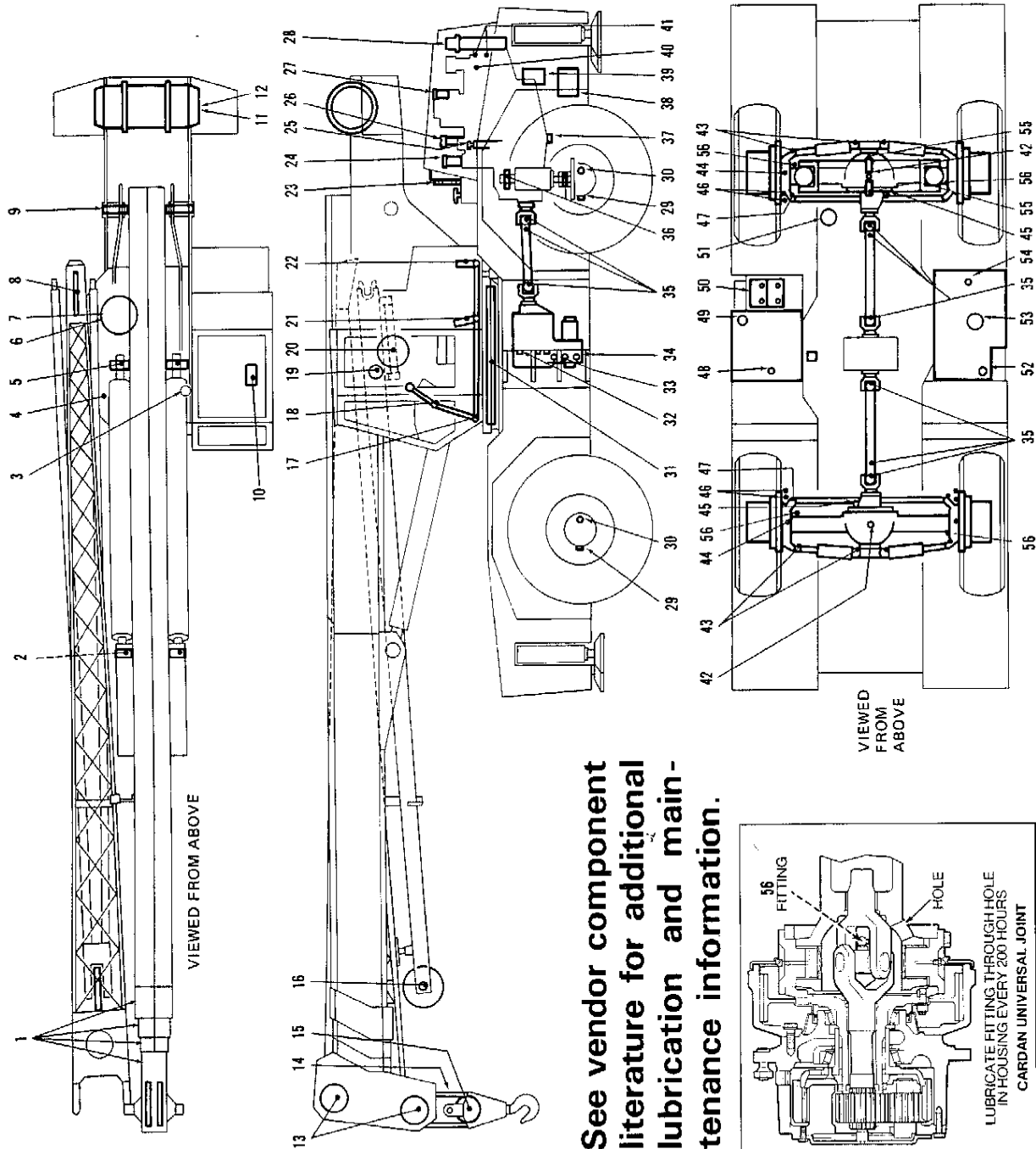

SYMBOLS
 ● = Fitting
 → = Other Service

LUBRICANT SYMBOLS
 ATF — Automatic Trans. Fluid
 CG — Grease
 DS — Dri Slide EP Liquid Grease
 EO — Engine Oil
 GO — Gear Lubricant
 HG — Hub Grease
 RL — Wire Rope Lubricant

See vendor component literature for additional lubrication and maintenance information.

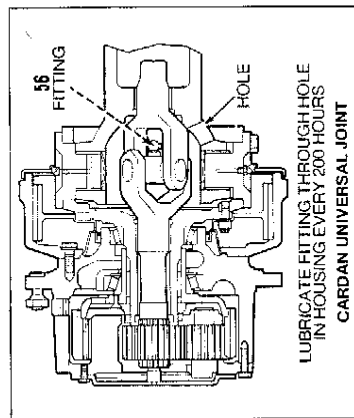

LUBRICATION NOTES
 Clean lubrication fittings before lubricating.
 Intervals shown are for normal (8 hour day) usage and conditions. Adjust intervals for abnormal usage and conditions.
 Lubricate points indicated by dotted leaders on both sides of unit.
 Drain engine and gear cases only after operation when lubricant is hot.
 Check lubricant levels when lubricant is cool.
 Clean filter and air cleaner housings and reusable elements using cleaning solvent. Dry components thoroughly using a lint free cloth.

Lubrication & Maintenance Schedule

ITEM	Lube Symbol	No. of Points	Interval (hrs.)			
			10	50	100	1500
1. Boom and Slider Pad (Apply lubricant to outer surfaces of boom sections nos. 2, 3 & 4.)	DS	-		X		
2. Boom Hoist Cylinder Rod Pivots	CG	2	X	X		
3. Throttle Reservoir	EO-10	1	X	X		
4. Swing Pinion and Ring Gear	CG	1	X	X		
5. Boom Hoist Cylinder Anchor Pivots	CG	2	X	X		
6. Swing Transmission Level Plug (Check level & replenish as required.)	GO-90	1	X			
7. Swing Transmission Drain Plug (Drain & refill to level. Approx. capacity is 8 qts. [7.6 Liters])	GO-90	1	X			X
8. Side Fly Sheave	CG	1	X			
9. Boom Pivot (Self-lubricating bearings.)	CG	1	X			
10. Boom Hoist Pedal	CG	1	X			
11. Winch Final Drive Level Plug (Excluding units w/ree fall.) (Check level & replenish as required.)	GO 70/90	1		X		
12. Winch Final Drive Drain Plug (Excluding units w/ree fall.) (Drain and refill to level.)	GO 70/90	1		X		
13. Boom Point Sheaves	CG	6 or 7	X			X
14. Wire Rope	FL					X
15. Hook Block Sheaves	CG	5	X			
16. Jib Sheave	CG	1	X			
17. Front Jackshaft (Aux. winch req. 1 additional fitting.)	CG	6				X
18. Control Levers (Aux. winch req. 1 additional fitting.)	CG	4				X
19. Jib Rollers	CG	2	X			
20. Gambly Sheave	CG	1	X			
21. Bell Cranks at 6 Spool Valve (Aux. winch requires 1 additional fitting.)	CG	3				X
22. Air Cleaner at 2 Spool Valve	CG	2				X
23. Air Cleaner (Discard old element, clean housing and install new element when scheduled & when indicated - Cummins V555 & Detroit Diesel engines; use P/N 7611-2415; Cummins 6CT8.3 engine; use 7610-9223.)		1		X		
24. Fuel Filters (Discard old element, clean housing and install new element - Cummins V555; P/N 8204-0383; Detroit Diesel; primary use P/N 7611-3487 & P/N 7611-3488 for secondary; Cummins 6CT8.3 use P/N 7612-6342 Fuel Strainer 76-7-0941 - Cummins 6CT8.3 only)		2		X		X
25. Crankcase Dipstick Check level & replenish as req'd.)	EO*	1	X			
26. Crankcase Filler Tube (Add oil as req'd.)	EO*	1	X			
27. Engine Coolant Filter (Cummins engines only) (Discard old element, clean housing & install new element V555 - P/N 8204-0382; 6CT8.3 - P/N 7612-6341.)		1	X			
28. Radiator (Check coolant level and replenish as req'd.)		1	X			
29. Axle Planetary Drive Drain Plug (Drain & refill to level - approx. capacity is 6 pints [2.8 Liters].)	GO-90	4				X
30. Axle Planetary Drive Level Plug (Check level and replenish as req'd.)	GO-90	4				X
31. Swing Bearing (Lubricate both fittings, swing 90° and lubricate again.)	CG	2				

ITEM	Lube Symbol	No. of Points	Interval (hrs.)			
			10	50	100	1500
32. Hydraulic Reservoir Sight Gauge (Position machine on level ground, retract all cylinders fully & stop engine. Open vent petcocks on reservoir & filter cover. Check level in sight gauges & replenish as req'd. Replace filter cap and close both vent petcocks.)	EO-10	1	X			
33. Transmission Level Plug (Top plug on right side of transmission - Check level and replenish as req'd.)	ATF	1		X		
34. Transmission Drain Plug (Drain and refill to level - Approximate capacity is 8 gal. [30.3 liters].)	ATF	1		X		X
35. Propeller Shaft Bearings and Splines	CG	9			X	
36. Oscillation Cylinder Pivots	CG	4			X	
37. Crankcase Drain (Drain and refill to level - Approx. capacity is 8.5 gal. [32.2 L] for Cummins V555 engine; 5.9 gal. [22.3 L] for Cummins 6CT8.3 engine; & 16.5 qts. [15.6 L] for Detroit Diesel engine.)	EO*	1*				X
38. Engine Oil By-Pass Filter (Cummins V555 engine only) (Discard old element, clean housing & install new element P/N 8204-0384.)		1				X
39. Engine Oil Filter (Discard old element, clean housing and install new element - Cummins V555 engine; P/N 8204-0678; Cummins 6CT8.3 engine; P/N 7612-6338; Detroit Diesel engine; P/N 7611-3484.)		1				X
41. Water Pump (Cummins V555 engine only.) (Remove plug, install fitting & lubricate. Remove fitting & install plug.)	HG	1				X
41. Fan Hub (Cummins V555 engine only.) (Remove plugs, install fittings & lubricate. Remove fittings & install plugs.)	HG	2				X
42. Differential Drain Plug (Drain & refill to level - approx. capacity is 42 pints [19.9 liters].)	GO-90	2			X	
43. Steering Cylinder Pivots	CG	8			X	
44. Steering Trunnions	CG	8			X	
45. Differential Fill and Level Plug (Check level and replenish as required.)	GO-90	2				X
46. Brake Shoe Pivots (Remove plug, install fitting, lubricate and replace plug.)	CG	4			X	
47. Tie Rod Pivots	CG	4			X	
48. Fuel Tank Drain Plug (Drain water and close.)		1			X	
49. Fuel Tank Filler Tube (Replenish fuel.)		1		X		
50. Batteries (Check level and add distilled water as required.)		12/16/30				X
51. Transmission Filter (Discard old element, clean housing and install new element - P/N 8211-2913.)		1			X	
52. Hydraulic Reservoir Filler Tube (Add oil as required.)	EO-10	1		X		
53. Hydraulic Reservoir Filter (Discard old element and install new element - P/N 7603-3107.)		1			X	
54. Hydraulic Reservoir Drain Plug (Drain and refill to level. Approx. system capacity is 220 gal. [833 liters].)		1				As req'd.
Hydraulic Reservoir Drain Plug (Drain water and close.)		1				X
55. Oscillation Cradle Pivots	CG	2				X
56. Cardan Universal Joint (See insert)	CG	4				See insert
57. Equalizing Sheaves	CG	4				X

* See page 60 for lubricant specifications.

LUBRICATION

RECOMMENDED LUBRICANTS

APPLICATION	SYMBOL/ITEM	WHEN USED	GRADE	SPECIFICATION OR P/N
Engine Crankcase (Cummins)	EO/Engine Oil	Below -10°F. (-23°C.) -10° to 14°F. (-23° to -10°C.) Above 14°F. (-10°C.)	See Mfr.'s Manual SAE 10W30 SAE 15W40 or 20W40	API Class CC
Engine Crankcase (Detroit Diesel)	EO/Engine Oil	All Year	SAE 40*	MIL-L-2104B/1964 MS Supplement 1
Swing Transmission & Axle	GO/Gear Lubricant	All Year	SAE 90	MIL-L-2105B
Transmission	ATF/Auto Trans. Fluid	All Year	-	Dexron
Hydraulic Reservoir & Throttle Reservoir	EO/Engine Oil	All Year	SAE 10**	MIL-L-2104C
Boom & Boom Wear Pads	DS/Dri Slide EP Liquid Grease	All Year	-	P/N 8162-0537
Wire Rope	RL/Wire Rope Lubricant	All Year	-	Engine Oil
Lubrication Fittings	CG/Grease	All Year	-	8162-0539***
Winch Final Drive	GO/Gear Lubricant	Below Freezing Above Freezing	SAE 70 SAE 90	MIL-L-2104C
Fan Hub & Water Pump (Cummins)	HG/Hub Lubricant	All Year	-	MIL-G-3545****

* SAE 30 may be used as required for cold weather starting

** Pour point must be below lowest expected temperature

*** Lithium base grease with Molybdenum Disulfide additive

**** Excluding those of sodium or soda soap thickeners





CAPACITIES (Capacities are approximate - check level)

Engine Crankcase (including filter):	Cummins V555	8.5 gal.	32.2 Liters
	Cummins 6CT8.3	5.9 gal.	22.3 Liters
	Detroit Diesel 6V53	16.5 qts.	15.6 Liters
Engine Cooling System:	Cummins V555	12 gal.	45.4 Liters
	Cummins 6CT8.3	8 gal.	30.3 Liters
	Detroit Diesel 6V53	12 gal.	45.5 Liters
Transmission (including torque converter & filter)		8 gal.	30.3 Liters
Front & Rear Axle Differentials (each)		42 pints	19.9 Liters
Front & Rear Axle Planetary Drive Housings (each)		6 pints	2.8 Liters
Hydraulic Reservoir		193 gal.	730.6 Liters
Hydraulic System		220 gal.	832.8 Liters
Fuel Tank		120 gal.	454.2 Liters
Throttle Reservoir		.5 pint	.2 Liters
Winch Final Drive (without Free Fall)			
Swing Transmission		8 qts.	7.6 Liters
Swing Transmission Gear Reducer		1 qt.	9 Liters

REPLACEMENT FILTER ELEMENTS

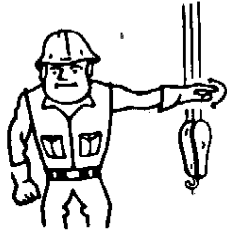
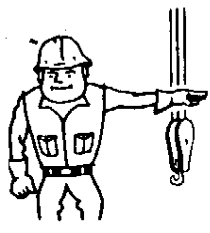
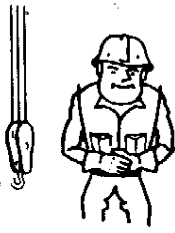
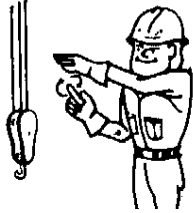
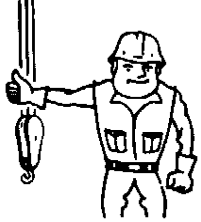
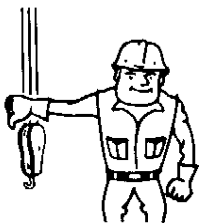
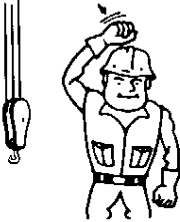
ITEM	CUMMINS V555	CUMMINS 6CT8.3	DETROIT DIESEL 6V53
Engine Oil Filter Element	8204-0678	7612-6338	7611-3484
Fuel Filter Element	8204-0383(2 req'd)	7612-6342(1 req'd)	-
Primary Fuel Filter Element	-	-	7611-3487
Secondary Fuel Filter Element	-	-	7611-3488
Engine Coolant Filter Element	8204-0382	7612-6341	-
Engine By-Pass Filter Element	8204-0384	-	-
Fuel Strainer -In-Line	-	7607-0941	-
Air Compressor Breather Element	-	-	8210-7588
Air Cleaner Element	7611-2415	7610-9223	7611-2415
Transmission Filter Element	8211-2913	8211-2913	8211-2913
Hyd. Reservoir Filter Element	7603-3107	7603-3107	7603-3107
Hyd. Reservoir Magnet	8203-3523	8203-3523	8203-3523
Air Drier Element	7610-6643	7610-6643	7610-6643

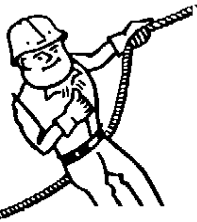
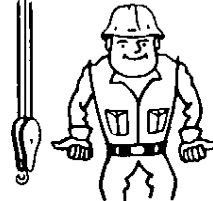
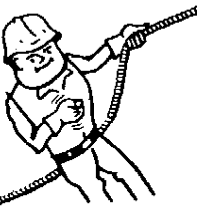
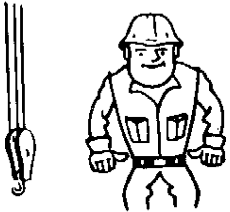
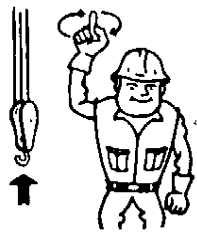
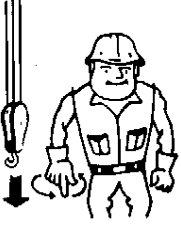
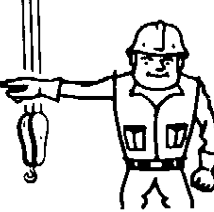
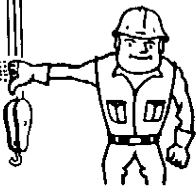
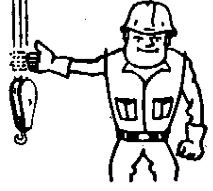
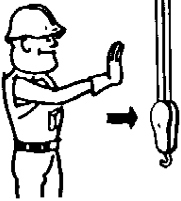
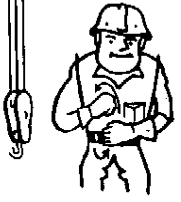
HAND SIGNALS

 <p>EMERGENCY STOP. Arm extended, palm down, move hand rapidly right and left.</p>	 <p>STOP. Arm extended, palm down, hold position rigidly.</p>	 <p>DOG EVERYTHING. Clasp hands in front of body.</p>	 <p>MOVE SLOWLY. Use one hand to give any motion signal and place other hand motionless in front of hand giving the motion signal. (Hoist Slowly shown as example)</p>
 <p>RAISE BOOM. Arm extended, fingers closed, thumb pointing upward.</p>	 <p>LOWER BOOM. Arm extended, fingers closed, thumb pointing downward.</p>	 <p>USE MAIN HOIST. Tap fist on head; then use regular signals.</p>	 <p>USE WHIP LINE. (Auxiliary Hoist) Tap elbow with one hand; then use regular signals.</p>
 <p>EXTEND BOOM. (Telescoping Boom) One Hand Signal. One fist in front of chest with thumb tapping chest.</p>	 <p>EXTEND BOOM. (Telescoping Booms) Both fists in front of body with thumbs pointing outward.</p>	 <p>RETRACT BOOM. (Telescoping Boom) One Hand Signal. One fist in front of chest, thumb pointing outward and heel of fist tapping chest.</p>	 <p>RETRACT BOOM. (Telescoping Booms) Both fists in front of body with thumbs pointing toward each other.</p>
 <p>HOIST. With forearm vertical, forefinger pointing up, move hand in small horizontal circle.</p>	 <p>LOWER. With arm extended downward, forefinger pointing down, move hand in small horizontal circles.</p>	 <p>SWING. Arm extended point with finger in direction of swing of boom.</p>	 <p>LOWER THE BOOM AND RAISE THE LOAD. With arm extended, thumb pointing down, flex fingers in and out as long as load movement is desired.</p>
 <p>RAISE THE BOOM AND LOWER THE LOAD. With arm extended, thumb pointing up, flex fingers in and out as long as load movement is desired.</p>	 <p>TRAVEL. Arm extended forward, hand open and slightly raised, make pushing motion in direction of travel.</p>	 <p>TRAVEL. (Both Tracks) Use both fists (both in front of body, making a circular motion, about each other, indicating direction of travel; forward or backward. (For crawler cranes only)</p>	 <p>TRAVEL. (One Track) Lock the track on side indicated by raised fist. Travel opposite track in direction indicated by circular motion of other fist, rotated vertically in front of body. (For crawler cranes only)</p>