

STC800

STC800 TRUCK CRANE
80 TONS LIFTING CAPACITY

Quality Changes the World

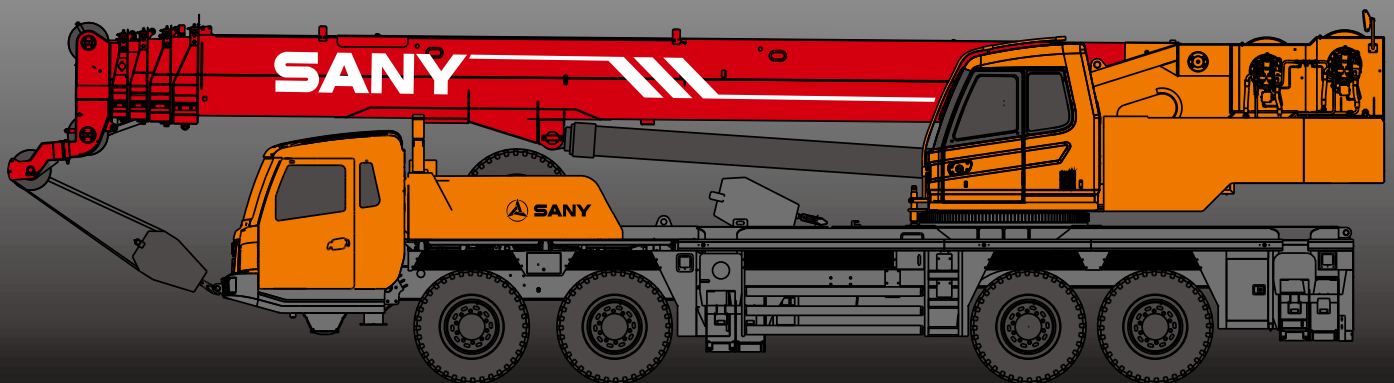

SANY

■ SANY Automobile Hoisting Machinery is one of the core business units of Sany Heavy Industry, mainly engaged in the research and development of high-end, mid-to-large tonnage crane series, including mobile crane, crawler crane, tower crane and loader crane. It has two industrial parks in Ningxiang and Huzhou. Since entering the market, the products of Sany Automobile Hoisting Machinery have received worldwide recognition with advanced technology, lean manufacturing, high reliability and excellent service.



SANY TRUCK CRANE

CONTENT

- 04 Icon
- 05 Selling Points
- 06 Introduction
- 09 Dimension
- 10 Technical Parameter
- 11 Operation Condition
- 12 Load Chart
- 14 Wheel Crane Family Map

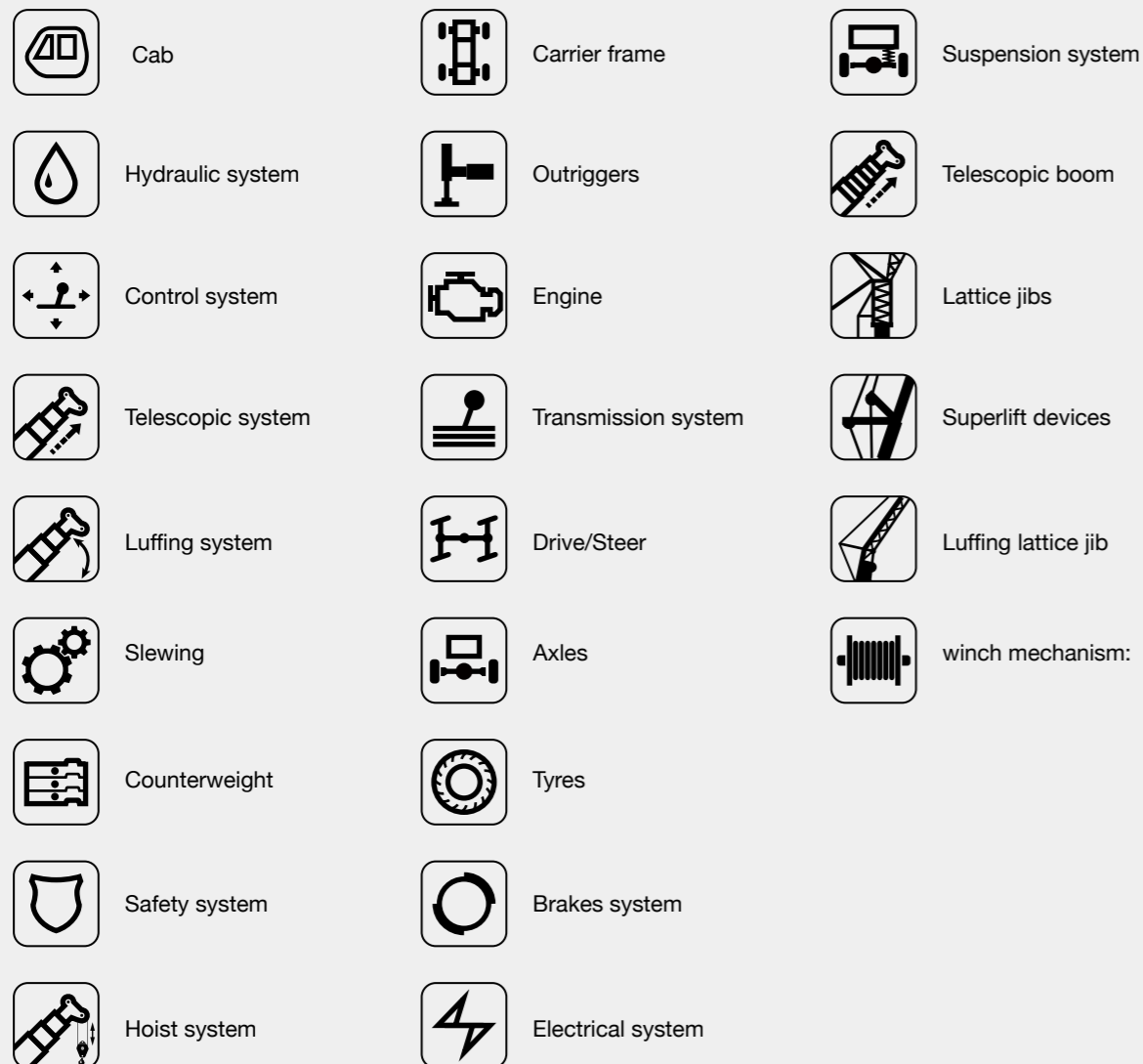

Excellent and stable chassis performance / chassis system

Double-axle drive is used, providing good trafficability and comfortableness under complex road condition with reliable traveling performance.

Engine has the multimode power output function, which reduces power consumption.

The use of tipping over early-warning technology provides high stability and safety of the overall operation.



Highly efficient, stable, energy-saving and adjustable hydraulic system

Hydraulic system load feedback and constant power control is applied to provide strong lifting capacity and good micro-mobility. Unique steering buffer design is adopted to ensure stable braking operation.



Super-strong, super-long and sensitive lifting capacity

Five-section boom of high strength steel structure and optimized U-shaped section reduces weight significantly with higher safety rates. Jib mounting angles are 0°, 15° and 30°, which ensures fast and convenient change-over between different operating conditions so as to improving working efficiency of the machine.





Safe, stable, advanced and intelligent electric control system

Self-developed controller SYMC specially for engineering machinery is configured. The adoption of CAN-bus full-digital network control technology ensures stable control signal, simple harness and high reliability. Timely feedback of data information can achieve the monitoring of the overall working status in real-time. The load moment limiter equipped with the comprehensive intelligent protection system is used with accuracy within 5% to provide a comprehensive logic and interlock control, thus ensuring more safe and reliable operation.

Superstructure

-  **Cab**
- It is made of safety glass and anti-corrosion steel plate with ergonomic design such as full-coverage soften interior, panoramic sunroof and adjustable seats etc., and humanized design providing more comfortable and relaxing operation experience. The display of load moment limiter integrates main console and operation display system, which clearly show the data of all operating superstructure conditions for lifting operation.

-  **Hydraulic system**
- High-quality key hydraulic components such as main oil pump, rotary pump, main valve, winch motor and balancing parts etc. are adopted to achieve stable and reliable operation of the hydraulic system. Superior operation performance is guaranteed by accurate parameter matching.
 - Through the adoption of load sensitive variable displacement piston pump, pump displacement can be adjusted in real-time, achieving high-precision flow control with no energy loss during operation.
 - Main valve has flow compensation and load feedback control function, enabling stable and convenient control of single action and combined action under different operation conditions.
 - Winch adopts the electronically controlled variable motor to ensure high operation efficiency. Max. single line speeds of main and auxiliary winches is up to 130m/min.
 - Slewing system is equipped with the integrated slewing buffer valve, with free slipping function to ensure more stable starting and control of the slewing operation and excellent micro-mobility.
 - Hydraulic oil tank capacity: 980L.

-  **Control system**
- CAN-bus instrument: CAN-bus instrument with a combined intelligent control electrical system is used for easy reading of the traveling parameters at any time. The engine fault warning function is applied to ensure convenient and fast troubleshooting.
 - Automatic outrigger system: Electrically controlled outrigger with automatic leveling and fault diagnosis warning function is adopted, which is flexible and flexible to operate.
 - With fully security protection system, main and auxiliary winches are equipped with over-roll out limiter and height limiters to prevent over-rolling out and over-hoisting of steel rope, including tip-over and limit angle protection.
 - Load moment limiter: The adoption of high intelligent load moment limiter system can comprehensively protect lifting operation, ensuring accurate, stable and comfort operation.
 - The IO monitoring system can monitoring the input and output situation of the superstructure electricity system and can detect hydraulic system, chassis (for major safety failure), engine and gearbox for fault to ensure reliable operation of the crane.

-  **Luffing system**
- Dead-weight luffing provides more stable luffing operation at low energy loss.
 - Luffing angle: $-2^{\circ} \sim 80^{\circ}$.

-  **Telescopic system**
- Five-section boom is applied with basic boom length of 11.8m, full-extended boom length of 45m, jib length of 16m and fully extended boom lifting height of 46.4m respectively. Max. lifting height is 62.2m including jib. It is made of fine grain high-strength steel with U-shaped cross section and with telescopic operation controlled independently by dual-cylinder rope.

-  **Slewing system**
- 360° rotation can be achieved with Max. slewing speed of 1.8r/min. Hydraulic controlled proportional speed adjustment is applied to provide stable and reliable operation of the system. Unique rotary buffer design ensures more stable braking.

Superstructure

-  **Hoisting system**
- The adoption of pump and motor double variable speed control ensures high efficiency and excellent energy saving functionality. With perfect combination of winch balance valve and unique anti-slip technology, heavy load can be lifted and lowered smoothly. Closed winch brake and winch balance valve effectively prevent imbalance of the hook.
 - One main hook: 718Kg, one auxiliary hook: 354Kg. Wire rope of main winch: wire rope 20-35W \times 7-1960USZ 245m. Wire rope of auxiliary winch: wire rope 20-35W \times 7-1960USZ 145m.

-  **Safety system**
- Load moment limiter: Load moment limiter calculation system based on lifting load mechanical model is established using an analytical mechanics method with rated lifting accuracy up to $\pm 5\%$ through on-line non-load calibration, providing full protection to lifting operation. In case of overload operation, system will automatically issue an alarm to provide safety protection for manipulation.
 - Hydraulic system is configured with the balance valve, overflow valve and two-way hydraulic lock etc. components, thus achieving stable and reliable operation of the hydraulic system.
 - Main and auxiliary winches are equipped with over roll-out limiter to prevent over rolling-out of wire rope.
 - Boom and jib ends are equipped with height limiters respectively to prevent over-hoisting of wire rope.
 - Boom head is equipped with anemometer to detect whether the high altitude wind speed is within the allowable working range.
 - Equipped with length sensor, angle sensor and press sensor to indicate the working condition of whole crane in real-time, giving an alarm and cutting off the dangerous action automatically.

-  **Counterweight**
- Counterweight is 4000kg, no flexible counterweight.

Chassis

-  **Cab**
- Cab is made of new steel structure self-developed by SANY, featuring excellent shock absorption and tightness, which is configured with swing-out doors at both sides, pneumatically suspended driver's seat and passenger's seat, adjustable steering wheel, large rearview mirror, comfortable driver's chair with a headrest, anti-fog fan, air conditioner, stereo radio and complete control instruments and meters, providing more comfortable, safe and humanized operation experience.

-  **Carrier frame**
- Designed and manufactured by SANY, anti-torsion box structure is welded by fine-grain high-strength steel plate to provide strong load bearing capacity.

-  **Axles**
- Axles 3 and 4 are drive axles and axles 1 and 2 are steering axles, axle and wheel differentials are installed in axle 3 and wheel differential is installed in axle 4. The use of welding process for axle housing provides stronger load bearing capacity.

-  **Engine**
- Type: Inline six-cylinder, water cooled, supercharged and inter-cooling diesel engine
 - Rated power: 275kw/2100r/min
 - Environment-protection: Emission complies with EuroIII standard
 - Capacity of fuel tank: 350L

Chassis

- Transmission system**
- Gearbox: Manual gearbox with 9-gear is adopted, 9 forward gears and 1 reverse gear which is easy to operate, with large speed ratio range applied, which meets the requirements of low gradeability speed and high traveling speed.
 - Transmission shaft: With optimized arrangement of the transmission shaft, the transmission is stable and reliable. For most optimized transmission, face-tooth coupling transmission shaft is used with large transmission torque.
- Brakes system**
- Air servo brakes are used for all wheels with dual-circuit brake system applied, engine is equipped with an exhaust brake.
 - Brakes system includes traveling brake, parking brake, emergency brake and auxiliary brake.
 - Traveling brake: All wheels use the air servo brakes and dual-circuit brake system.
 - Parking brake: Force driven by accumulator is applied on the third to fourth axle.
 - For emergency brake, accumulator is used not only for cutting-off brake but also for emergency brake.
 - Auxiliary brake is exhaust brake with brake safety ensured while travelling downhill.
- Suspension system**
- All axles adopt the plate spring suspension systems with plate spring passed 100,000 fatigue tests and with optimization of performance parameters of the front and rear plate springs applied to ensure strength and also to provide comfort ridding.
- Steering system**
- Hydraulic power mechanical steering system is applied for axle 1 with unloading valve installed in the steering gear.
- Drive/Steer**
- 8 x 4
- Outriggers**
- Four-point supporting of the H-shaped outriggers ensures easy operation and strong stability with Max. span up to 6.1m×7.6m. They are made of fine-grain high-strength steel sheet with full hydraulic transverse telescopic outriggers adopted for first and second outriggers and with automatic horizontal adjustment applied for outriggers through a vertical cylinder.
- Tyres**
- 12x12.00R24 20PR
- Electrical system**
- With 2*12V maintenance-free batteries, the crane power can be cut off manually via a mechanical master power switch. The use of CAN-bus control system can achieve information interaction between superstructure and undercarriage.

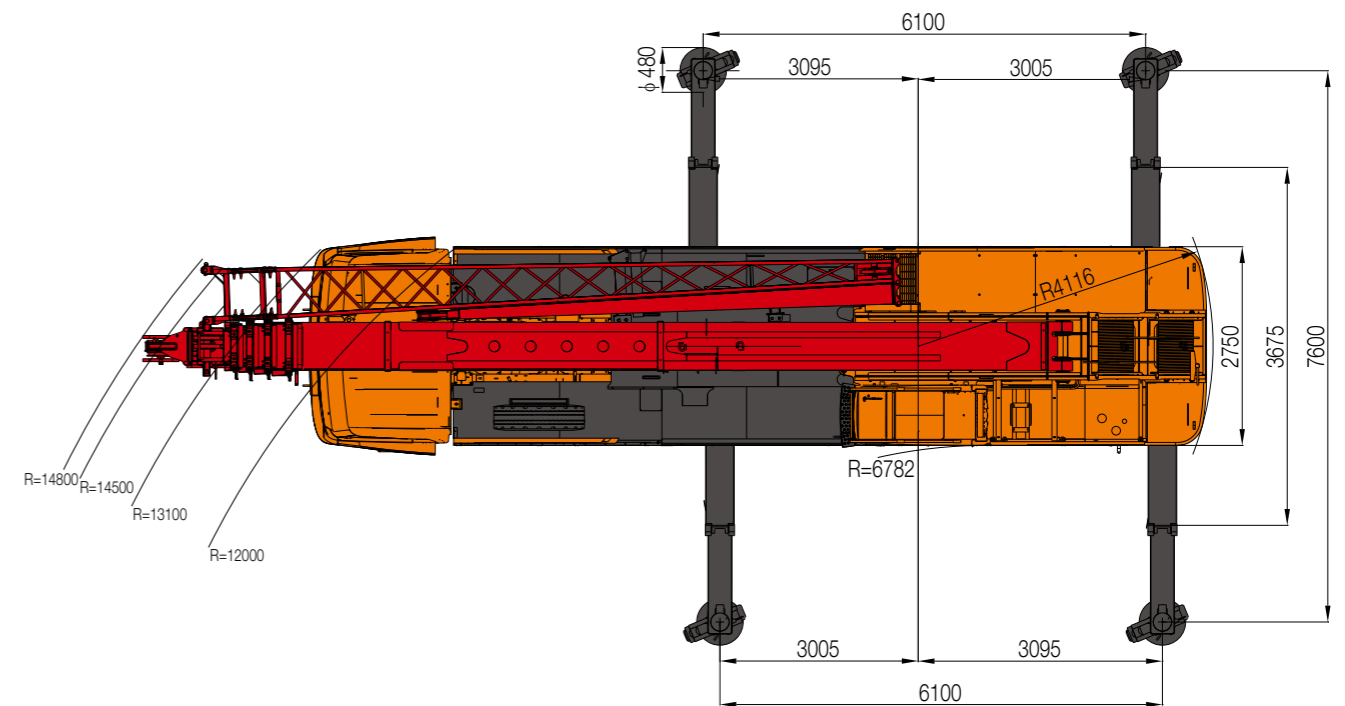
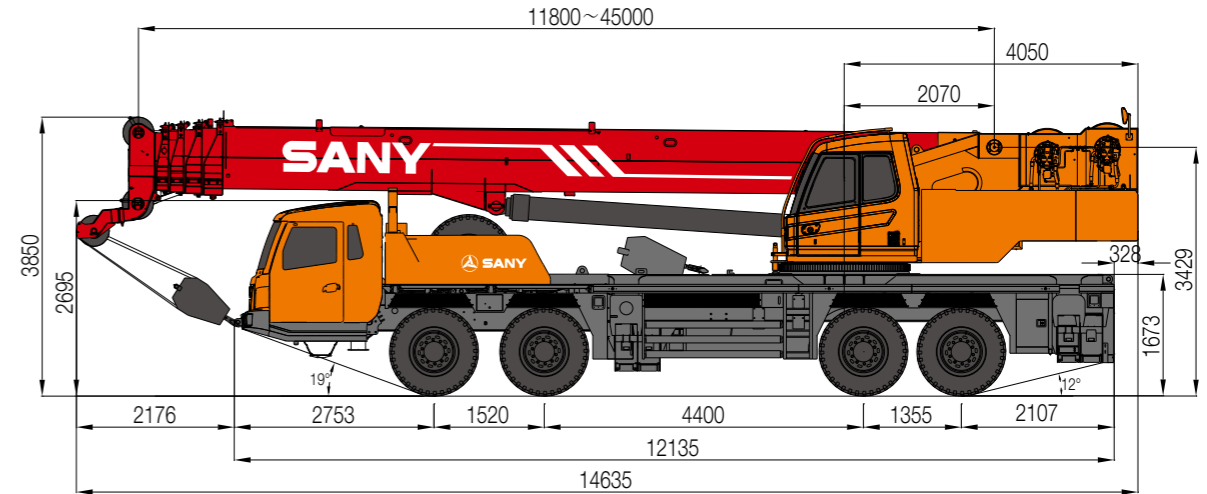

Type	Item	Parameter	
Capacity	Max. lifting capacity	80 t	
Dimensions	Overall length	141000 mm	
	Overall width	2750 mm	
	Overall height	3850 mm	
	Axle distance	Axle-1,2: 1520 mm Axle-2,3: 4400 mm Axle-3,4: 1355 mm	
Weight	Overall weight	45800 kg	
	Axle load	Axle load-1,2: 17500 kg Axle load-3,4: 28300 kg	
	Rated power	275 kW/ 2100 rpm	
	Rated torque	1500 N·m/1300-1500 rpm	
Traveling	Max.traveling speed	80 km/h	
	Turning radius	Min.turning radius	12 m
		Min.turning radius of boom head	14.5 m
	Wheel formula	8 × 4	
	Min.ground clearance	290 mm	
	Approach angle	19 °	
	Departure angle	12 °	
	Max.gradeability	35%	
Fuel consumption per 100km	≤ 56 L		
Main Performance Data	Temperature range	- 20 °C ~ +40 °C	
	Min.rated range	3 m	
	Tail slewing radius of swingtable	4.1 m	
	Boom section	5	
	Boom shape	U-shaped	
	Max.lifting moment	Base boom	2550 kN·m
		Full-extend boom	1232 kN·m
		Full-extend boom+jib	363 kN·m
	Boom length	Base boom	11.8 m
		Full-extend boom	45 m
Full-extend boom+jib		61 m	
Outrigger span (Longitudinal×Transversal)	6.1 × 7.6 m		
Jib offset	0 °, 15 °, 30 °		
Working speed	Max.single rope lifting speed of main winch (no load)	130 m/min	
	Max.single rope lifting speed of auxiliary winch (no load)	130 m/min	
	Full extension/retraction time of boom	120/100 s	
	Full lifting/descending time of boom	60 / 80 s	
	Slewing speed	1.8 r/min	
Aircondition	Aircondition in up cab	Cooling	
	Aircondition in low cab	Cooling/Heating	

STC800 Working Ranges

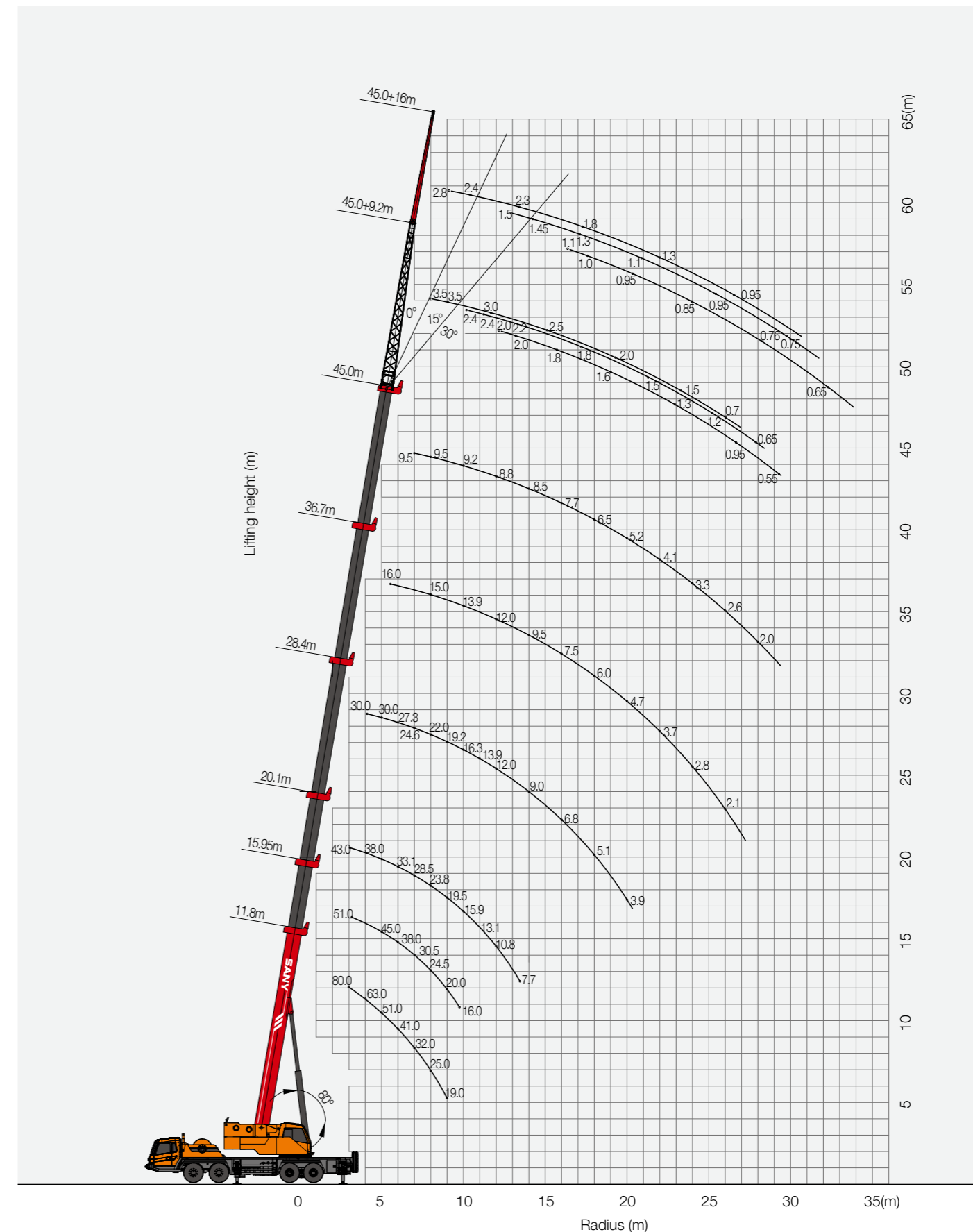

Unit:Kg

Prerequisites:

- ① Boom operating conditions(fully extended boom length),min.length is 11.8m and max.length is 45m
- ② The span of outriggers is 6.1m×7.6m
- ③ 360°rotation is applied
- ④ Counterweight is 4T

Working range(m)	Main boom						Working range(m)
	11.8	15.95	20.1	28.4	36.7	45	
3	80000	51000					3
3.5	71000	51000	43000				3.5
4	63000	51000	43000				4
4.5	56000	48000	40500	30000			4.5
5	51000	45000	38000	30000			5
5.5	46000	42000	35400	28500			5.5
6	41000	38000	33100	27300			6
6.5	36000	34000	31000	26000	16000		6.5
7	32000	30500	28500	24600	16000		7
8	25000	24500	23800	22000	15000	9500	8
9	19000	20000	19500	19200	14500	9500	9
10		16000	15900	16300	13900	9200	10
11		13000	13100	13900	13000	9000	11
12		10500	10800	12000	12000	8800	12
14			7700	9000	9500	8500	14
16			5500	6800	7500	7700	16
18			3800	5100	6000	6500	18
20				3900	4700	5200	20
22				2900	3700	4100	22
24				2100	2800	3300	24
26				1500	2100	2600	26
28					1600	2000	28
30					1200	1600	30
32					800	1200	32
34					500	900	34
36						600	36
Number of lines	12	9	9	6	5	3	Number of lines
Telescoping condition(%)							
Elevation angle of main boom	27.03°~69.8°	32.61°~75.29°	29.61°~78.41°	26.0°~79.79°	31.0°~79.74°	42.24°~79.72°	Elevation angle of main boom
2nd boom	0%	50%	100%	100%	100%	100%	2nd boom
3rd boom	0%	0%	0%	33%	66%	100%	3rd boom
4th boom	0%	0%	0%	33%	66%	100%	4th boom
Top boom	0%	0%	0%	33%	66%	100%	Top boom

1. Values listed in the table refer to rated lifting capacity measured at flat and solid ground under the lever state of the crane.
2. Value above heavy line shall be determined by strength of the crane and under this line shall be determined by stability of the crane.
3. Rated load values determined by stability shall comply with ISO 4305.
4. Rated lifting capacity listed in the table included weights of lifting hooks (718kg of main hook and 354kg of auxiliary hook)and hangers.
5. Rated lifting capacity with pulley at boom tip shall not exceed 4000kg and then subtracts(2300kg)to gain rated lifting capacity if the boom is used to lift after the installation of jib.
6. If actual boom length and range are between two values specified in the table, larger value will determine the lifting capacity.

Unit:Kg

Prerequisites:

- ① Boom operating conditions(fully extended boom length +jib length),max.length is 45m+9.2m
- ② The span of outriggers is 6.1m×7.6m
- ③ 360°rotation is applied
- ④ Counterweight is 4T

Main boom angle(°)	Main boom+Jib		
	0°	15°	30°
80°	3500	2400	2000
78°	3500	2400	2000
77°	3200	2300	1900
75°	3000	2200	1800
73°	2700	2000	1700
71°	2500	1800	1600
68°	2200	1700	1400
66°	2000	1500	1300
63°	1800	1400	1100
61°	1500	1200	950
58°	1100	950	750
56°	700	650	550
Min.elevation angle(°)	55°		

Unit:Kg

Prerequisites:

- ① Boom operating conditions(fully extended boom length +jib length),max.length is 45m+16m
- ② The span of outriggers is 6.1m×7.6m
- ③ 360°rotation is applied
- ④ Counterweight is 4T

Main boom angle(°)	Main boom+Jib		
	0°	15°	30°
80°	2800	1500	1100
78°	2400	1450	1000
77°	2400	1400	1000
75°	2300	1300	950
73°	2000	1200	850
71°	1800	1100	850
68°	1500	1000	800
66°	1300	950	760
63°	1100	850	720
61°	950	750	650
58°	650	600	550
56°	500		
Min.elevation angle(°)	55°		

STC800 TRUCK CRANE
WHEEL CRANE FAMILY MAP

TRUCK CRANE



STC200
Maximum Load Capacity: 20t
Telescopic Boom: 4 Sections, 10.6-33m



STC250
Maximum Load Capacity: 25t
Telescopic Boom: 4 Sections, 10.65-33.5m



STC250H
Maximum Load Capacity: 25t
Telescopic Boom: 5 Sections, 10.5-39.5m



STC300TH
Maximum Load Capacity: 30t
Telescopic Boom: 4 Sections, 10.6-33.5m



STC300H
Maximum Load Capacity: 30t
Telescopic Boom: 5 Sections, 10.5-39.5m



STC500
Maximum Load Capacity: 50t
Telescopic Boom: 5 Sections, 11.5-43m



STC550
Maximum Load Capacity: 55t
Telescopic Boom: 5 Sections, 11.5-43m



STC550EYR
Maximum Load Capacity: 55t
Telescopic Boom: 5 Sections, 11.5-43m



STC600
Maximum Load Capacity: 60t
Telescopic Boom: 5 Sections, 11.5-43m



STC750
Maximum Load Capacity: 75t
Telescopic Boom: 5 Sections, 11.8-45m



STC800
Maximum Load Capacity: 80t
Telescopic Boom: 5 Sections, 11.8-45m



STC800EYR
Maximum Load Capacity: 80t
Telescopic Boom: 5 Sections, 11.8-45m



STC1000
Maximum Load Capacity: 100t
Telescopic Boom: 5 Sections, 13.5-52m



STC1000C
Maximum Load Capacity: 100t
Telescopic Boom: 6 Sections, 13.25-60m



STC1300C
Maximum Load Capacity: 130t
Telescopic Boom: 6 Sections, 13.3-60m

ALL TERRAIN CRANE



SAC1800
Maximum Load Capacity: 180t
Telescopic Boom: 6 Sections, 13.5-62m



SAC2200
Maximum Load Capacity: 220t
Telescopic Boom: 6 Sections, 13.5-62m



SAC3000
Maximum Load Capacity: 300t
Telescopic Boom: 7 Sections, 15.4-80m



SAC3500
Maximum Load Capacity: 350t
Telescopic Boom: 6 Sections, 15.2-70m



SAC6000
Maximum Load Capacity: 600t
Telescopic Boom: 7 Sections, 17.1-90m

ROUGH-TERRAIN CRANE



SRC350
Maximum Load Capacity: 35t
Telescopic Boom: 4 Sections, 10-31.5m



SRC550
Maximum Load Capacity: 55t
Telescopic Boom: 4 Sections, 11.25-34.5m



SRC550H
Maximum Load Capacity: 55t
Telescopic Boom: 5 Sections, 11.5-42.5m



SRC750
Maximum Load Capacity: 75t
Telescopic Boom: 5 Sections, 11.8-45m



Quality Changes the World

SANY AUTOMOBILE HOISTING MACHINERY

Address: SANY Industrial Park, Jinzhou Development Zone,
Changsha, Hunan, China.
Service Hotline: 4006098318
Email: crd@sany.com.cn
For more information, please visit: www.sanygroup.com

For our consistent improvement in technology, specifications may change without notice.
The machines illustrated may show optional equipment which can be supplied at additional cost.

Distributed By:

--