



MICRO SERIE





1

Proportional distributor with single side controls. "HO" hydraulic lifting moment limiting device[°] for automatic load conditions and truck/crane unit stability control.

Distributeur proportionnel avec poste de commande monolatéral. Limiteur de moment "HO"[°] hydraulique pour le contrôle automatique des conditions de charge et de la stabilité de l'ensemble du camion et de la grue.

Distribuidor proporcional con puesto de mando monolateral. Limitador de impulso "HO"[°] hidráulico para el control automático de las condiciones de carga y de la estabilidad de la unidad camión/grúa.

2

Machine base in ductile cast iron for ideal stress distribution and superior strength. Powerful turntable mechanism with hydraulic motor.

Enbase en moulage de fonte sphéroïdale pour une distribution optimale des contraintes et une résistance élevée. Puissant système de rotation par moteur hydraulique.

Base esferoidal de hierro fundido para lograr una distribución adecuada de las fuerzas y una mayor resistencia. Potente sistema de rotación con motor hidráulico.

3

Hydraulic oil tank (4 gallon, 15 litre)[°] with filter in high strength, puncture resistant and totally corrosion proof plastic.

Réservoir d'huile[°], avec filtre, d'une capacité de (4 gal, 15 l), en matière plastique particulièrement résistante aux chocs et à l'action corrosive de tout agent extérieur.

Depósito del aceite[°] con filtro, con (4 gal, 15 l) de capacidad, de plástico especialmente resistente a los golpes y a la acción corrosiva de cualquier elemento externo.

4

Hydraulic winch[°] with (1100 ft-lbs, 500 daN) load capacity complete with mechanical limit switch, mounted under crane boom.

Treuil hydraulique[°], monté sous le bras de la grue, d'une capacité de levage de (1100 ft-lbs, 500 daN), avec fin de course mécanique.

Cabrestante hidráulico[°] instalado bajo el brazo de la grúa, con una potencia de elevación de (1100 ft-lbs, 500 daN), con final de carrera mecánico.

5

Electro-hydraulic control unit[°] in protective ABS case. Battery operation available for use on vehicles with no power take off.

Centrale électrohydraulique[°], avec boîtier de protection en ABS. Fonctionnement sur batterie pour les véhicules dépourvus de prise de force.

Centralita electrohidráulica[°] con caja de protección en ABS. Funcionamiento con batería en vehículos carentes de tomas de fuerza.

Heavy advantages for light trucks

A small, tireless, and strong companion for your everyday lifting requirements. The Micro range of cranes lift about twice their own weight at full extension. The lightweight, compact design allows for the installation of these cranes within the load bays of light commercial vehicles, pick-ups, and narrow specialty vehicles for use in historical town centers. Depending on individual installation requirements, assembly and stabilizer kits are available for all possible applications, as well as a version powered by a 12 or 24 volt electro-hydraulic pump. A comprehensive range of original accessories, including a hydraulic winch, supplementary controls for operating hydraulic accessories, remote control systems, and a hydraulic moment limiter make the crane both versatile and convenient to use. Design according to European Regulation EN 12999.*

Avantages de poids pour les camions légers

Petit mais infatigable compagnon de travail de tous les jours. Les grues de la gamme Micro offrent l'avantage de pouvoir être logées dans le volume des véhicules commerciaux légers, des pick-up et des engins spéciaux particulièrement étroits, pour circuler dans les centres historiques. En fonction des exigences du montage, une série de kits de montage et de stabilisation et une version à alimentation par pompe électrohydraulique sous 12 ou 24 V sont disponibles. La large gamme des accessoires d'origine, comme le vérin hydraulique, la commande supplémentaire d'activation des accessoires hydrauliques, les commandes à distance, le limiteur de moment hydraulique, etc., permettent une utilisation universelle et avantageuse de la grue. Conception selon la Norme Européenne EN 12999.*

Ventajas pesadas para los carros ligeros

Una pequeña pero infatigable compañía en el trabajo cotidiano. Las grúas de la gama Micro ofrecen la ventaja de poder colocarse en la caja de los vehículos comerciales ligeros, pick-up y automóviles especiales de anchura reducida para poder circular por el casco antiguo de las ciudades. Para responder a las distintas necesidades de instalación, contamos con una gama de kits de montaje y estabilización apta para cualquier situación; del mismo modo, también está disponible una versión alimentada por bomba electrohidráulica de 12 o 24 volt. La amplia gama de accesorios de origen, como el pescante hidráulico, el mando supletorio para la activación de accesorios hidráulicos, los mandos a distancia, el limitador de impulso hidráulico, etc., hace que la grúa sea un instrumento versátil y de uso interesante. Proyecto según Normativa Europea EN 12999.*

MICRO M10A

M10A.11

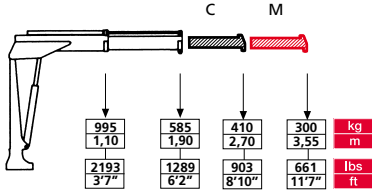

STD OPT.

TELESCOPIC MANUAL EXTENSIONS
RALLONGES MANUELLES TELESCOPIQUES
PROLONGAS MANUALES TELESCOPICAS

M10A.12

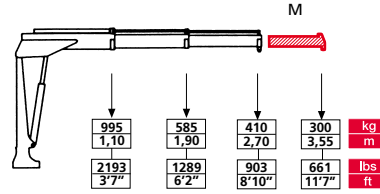

OPT.

TELESCOPIC MANUAL EXTENSIONS
RALLONGES MANUELLES TELESCOPIQUES
PROLONGAS MANUALES TELESCOPICAS

	tm lbs.ft	m ft	m ft	°	kNm lbs.ft	MPa psi	l/min gal/min	l gals.	kg lbs	kg lbs	kg lbs
M10A.11	1,1 7956	1,9 6'2"	0,8 2'7"	325	1,9 1402	18 2610	6 2	15 4	145 319	40 88	95 209
M10A.12	1,1 7956	2,7 8'10"	1,6 5'2"	325	1,9 1402	18 2610	6 2	15 4	155 341	40 88	95 209

MICRO M15A

M15A.11

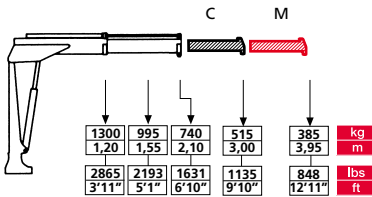

STD OPT.

TELESCOPIC MANUAL EXTENSIONS
RALLONGES MANUELLES TELESCOPIQUES
PROLONGAS MANUALES TELESCOPICAS

M15A.12

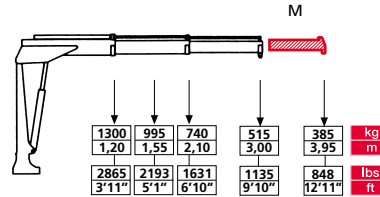

OPT.

TELESCOPIC MANUAL EXTENSIONS
RALLONGES MANUELLES TELESCOPIQUES
PROLONGAS MANUALES TELESCOPICAS

	tm lbs.ft	m ft	m ft	°	kNm lbs.ft	MPa psi	l/min gal/min	l gals.	kg lbs	kg lbs	kg lbs
M15A.11	1,5 10850	2,1 6'10"	0,8 2'7"	325	2,9 2410	18 2610	6 2	15 4	170 374	40 88	95 209
M15A.12	1,5 10850	3,0 9'10"	1,8 5'10"	325	2,9 2410	18 2610	6 2	15 4	180 396	40 88	95 209



For extra EC market - Pour les marchés extra CE - Para los markets extra CE



MICRO M20A

M20A.11

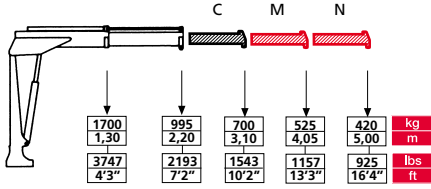

M20A.12

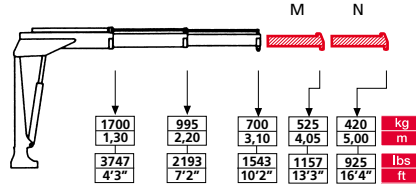

M20A.13

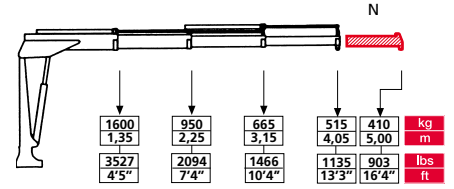

STD M N OPT.

TELESCOPIC MANUAL EXTENSIONS
RALLONGES MANUELLES TELESCOPIQUES
PROLONGAS MANUALES TELESCOPICAS

M N OPT.

TELESCOPIC MANUAL EXTENSIONS
RALLONGES MANUELLES TELESCOPIQUES
PROLONGAS MANUALES TELESCOPICAS

N OPT.

TELESCOPIC MANUAL EXTENSIONS
RALLONGES MANUELLES TELESCOPIQUES
PROLONGAS MANUALES TELESCOPICAS

	tm		m		ft		°		kNm		MPa		l/min		oil		kg		lbs	
	tm	lbs.ft	m	ft	m	ft	°	kNm	lbs.ft	MPa	psi	l/min	gal/min	l	gals.	kg	lbs	kg	lbs	
M20A.11	2,1	15189	2,2	6'10"	0,9	2'11"	325	3,4	2508	18	2610	8	2	15	4	195	429	95	209	
M20A.12	2,1	15189	3,1	9'10"	1,8	5'10"	325	3,4	2508	18	2610	8	2	15	4	210	462	95	209	
M20A.13	2,1	15189	4,0	13'3"	2,7	8'10"	325	3,4	2508	18	2610	8	2	15	4	240	529	95	209	

MICRO M25A

M25A.11

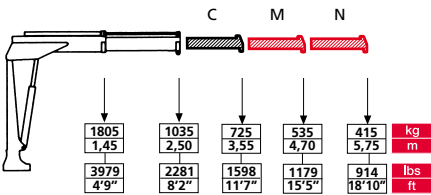

M25A.12

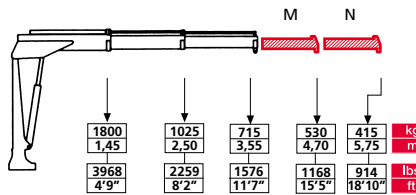

M25A.13

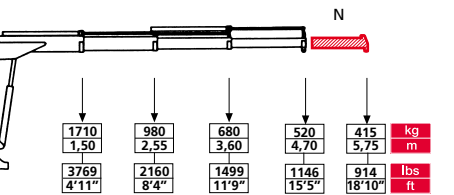

STD M N OPT.

TELESCOPIC MANUAL EXTENSIONS
RALLONGES MANUELLES TELESCOPIQUES
PROLONGAS MANUALES TELESCOPICAS

M N OPT.

TELESCOPIC MANUAL EXTENSIONS
RALLONGES MANUELLES TELESCOPIQUES
PROLONGAS MANUALES TELESCOPICAS

N OPT.

TELESCOPIC MANUAL EXTENSIONS
RALLONGES MANUELLES TELESCOPIQUES
PROLONGAS MANUALES TELESCOPICAS

	tm		m		ft		°		kNm		MPa		l/min		oil		kg		lbs	
	tm	lbs.ft	m	ft	m	ft	°	kNm	lbs.ft	MPa	psi	l/min	gal/min	l	gals.	kg	lbs	kg	lbs	
M25A.11	2,6	18806	2,5	8'2"	1,0	3'3"	325	3,4	2508	15,5	2250	8	2	15	4	215	473	100	220	
M25A.12	2,6	18806	3,5	11'5"	2,1	6'10"	325	3,4	2508	15,5	2250	8	2	15	4	230	507	100	220	
M25A.13	2,5	18083	4,7	15'5"	3,2	10'5"	325	3,4	2508	15,5	2250	8	2	15	4	260	573	100	220	

MICRO M30A

M30A.11

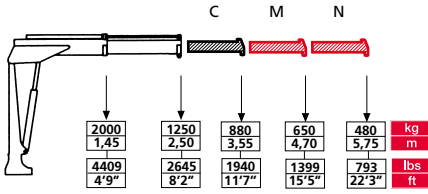

M30A.12

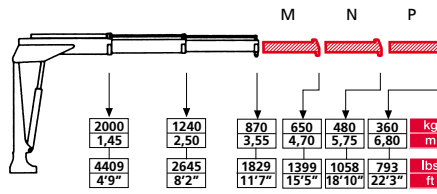

M30A.13

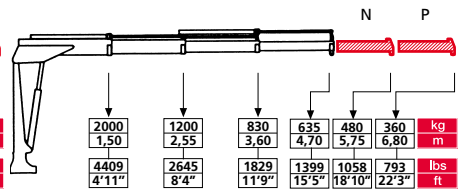

STD **M** **N** OPT.

TELESCOPIC MANUAL EXTENSIONS
RALLONGES MANUELLES TELESCOPIQUES
PROLONGAS MANUALES TELESCOPICAS

M **N** **P** OPT.

TELESCOPIC MANUAL EXTENSIONS
RALLONGES MANUELLES TELESCOPIQUES
PROLONGAS MANUALES TELESCOPICAS

N **P** OPT.

TELESCOPIC MANUAL EXTENSIONS
RALLONGES MANUELLES TELESCOPIQUES
PROLONGAS MANUALES TELESCOPICAS

	tm	lbs.ft	m	ft	m	ft	°	kNm	lbs.ft	MPa	psi	l/min	gal/min	l	gals.	kg	lbs	kg	lbs
M30A.11	3,1	22422	2,5	8'2"	1,0	3'3"	325	3,4	2508	18	2610	8	2	15	4	215	473	100	220
M30A.12	3,1	22422	3,5	3'5"	2,1	6'10"	325	3,4	2508	18	2610	8	2	15	4	230	507	100	220
M30A.13	3,0	21699	4,7	15'5"	3,2	10'5"	325	3,4	2508	18	2610	8	2	15	4	260	573	100	220

	A	B
Micro M10A	620 2'0"	1210 3'11"
Micro M15A	690 2'3"	1365 4'5"
Micro M20A.11/12	715 2'4"	1525 5'0"
Micro M20A.13	800 2'7"	1525 5'0"
Micro M25A.11/12	830 2'8"	1625 5'3"
Micro M25A.13	890 2'11"	1625 5'3"
Micro M30A.11/12	830 2'8"	1625 5'3"
Micro M30A.13	890 2'11"	1625 5'3"

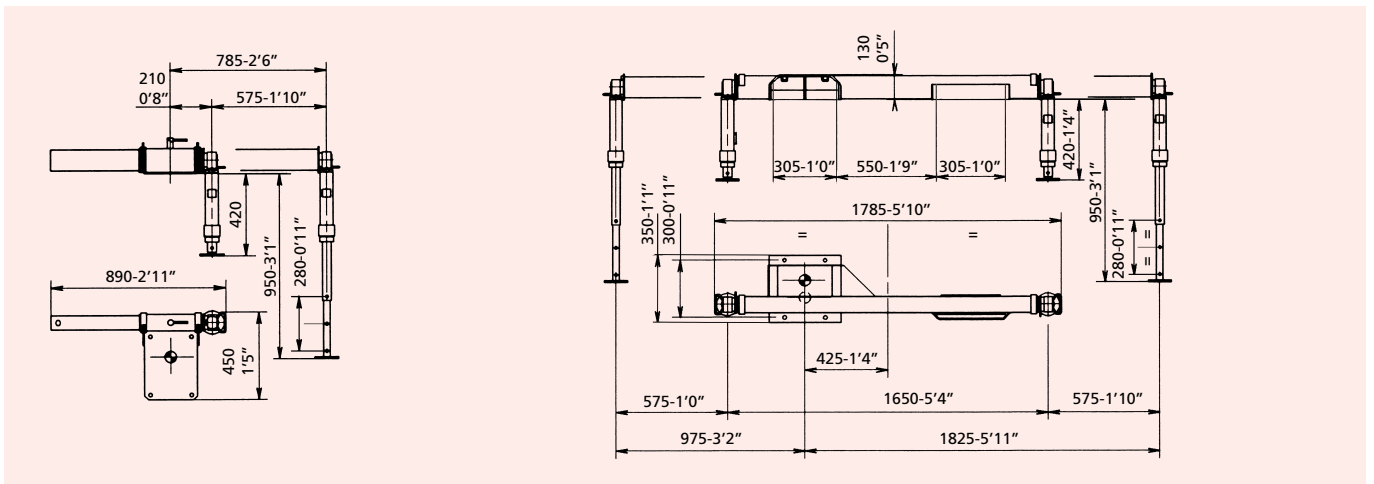
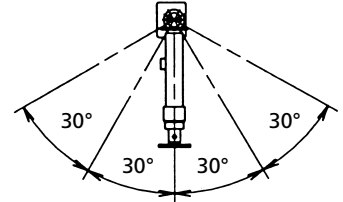
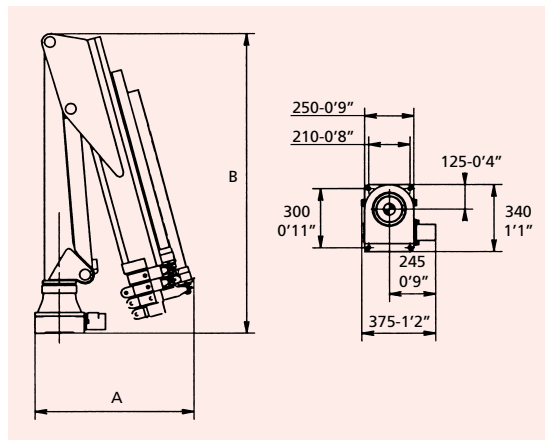



Data and descriptions are approximate and not binding - Toutes les données et descriptions sont fournies à titre indicatif, sans engagement - Datos y descripciones todos a título indicativo y no imperativo



FASSI GRU S.p.A. - Via Roma, 110 - 24021 Albino (Bergamo) ITALY
Tel: +39 035 776400 - Fax +39 035 755020
www.fassigroup.com - E-mail: fassi@fassigroup.com

