

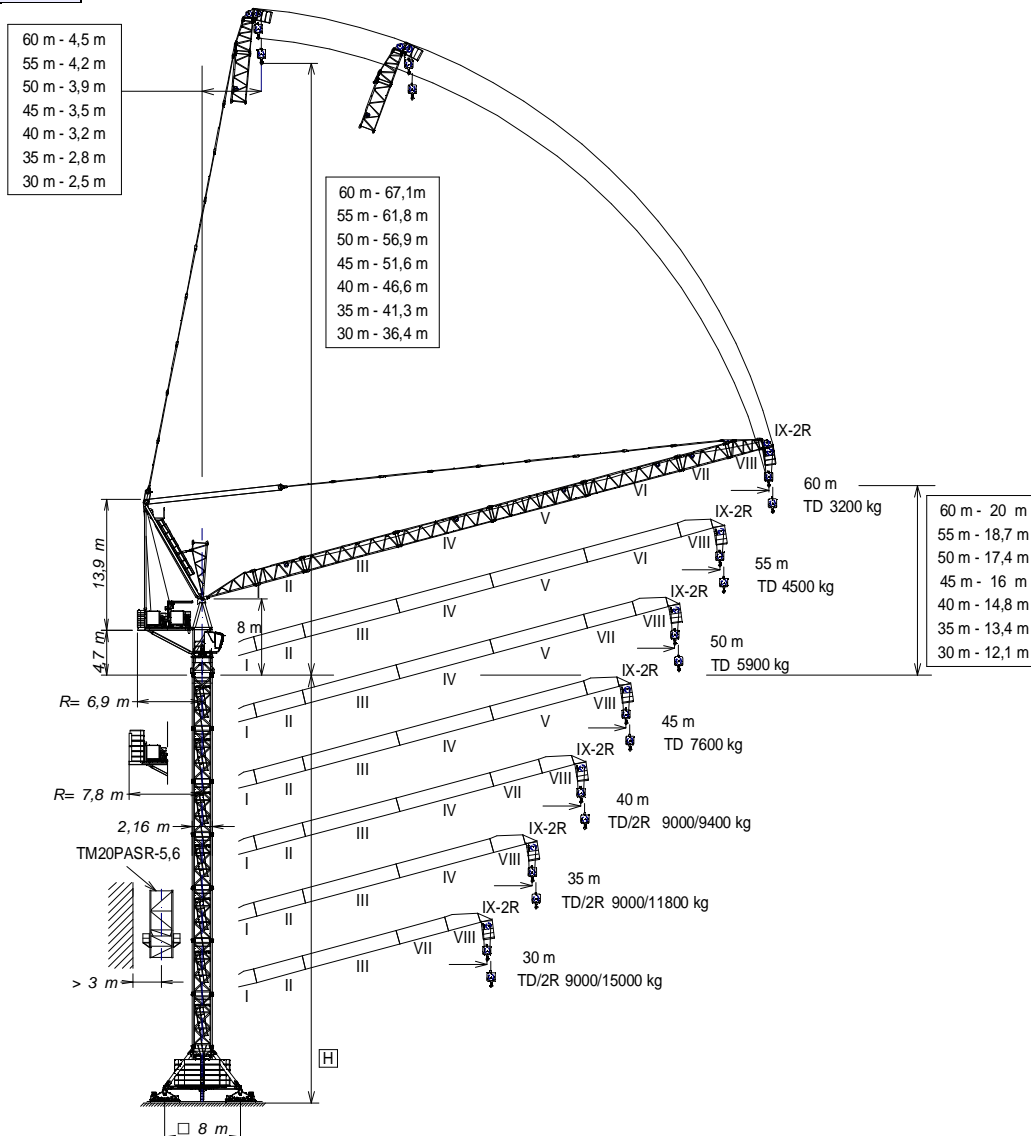

EN 14439
C25

UNE-EN-ISO 9001



Máxima altura de torre sin arriostrar (m). Maximum tower height without fastening (m). Hauteur maximale de tour sans ancrage (m). Максимальная высота башни без крепления (m). Desteksiz maksimum kule yüksekliği (m). أقصى ارتفاع للبرج بدون ربط (م)	H =		
* Tramo pluma / Jib section / Tronçon de flèche / Секция стрелы / Bom bölümü / أجزاء الذراع		*Tramo pluma I / Jib section I	204.40.000
		*Tramo pluma II / Jib section II	204.41.000
		*Tramo pluma III / Jib section III	204.42.000
		*Tramo pluma IV / Jib section IV	204.43.000
		*Tramo pluma V / Jib section V	204.44.000
		*Tramo pluma VI / Jib section VI	204.45.000
		*Tramo pluma VII / Jib section VII	204.46.000
		*Tramo pluma VIII / Jib section VIII	204.47.000
		*Tramo pluma IX-2R / Jib section IX-2R	204.49.200
		BSR18-20-5,6H	166.20.500
		ASR20	160.21.200
		TSR20	153.31.800
		TSR20-5,6	204.31.000
		TM20PASR-5,6	206.35.000
		ABH100B	204.23.000
		ABH100H	156.23.500

(H) TRASLACIÓN / TRAVELLING /

TRANSLATION / ПЕРЕМЕЩЕНИЕ / RAY YÜRÜYÜŞLÜ / متحركة

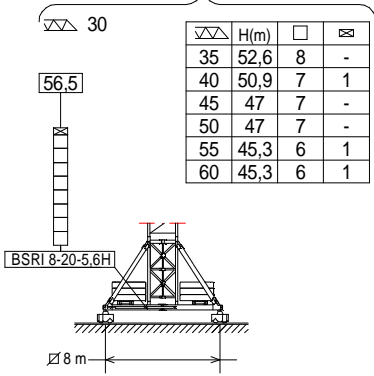

(H) ESTACIONARIA / STATIONARY /

STATIONAIRE / СТАЦИОНАРНОЕ СОСТОЯНИЕ / SABIT / ثابتة

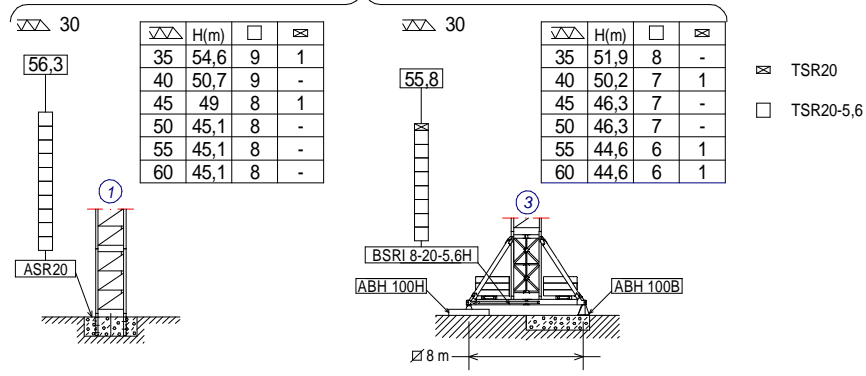





JASO EQUIPOS DE OBRAS Y CONSTRUCCIONES, S.L.



FEM 1005 - C25













Reservado el derecho a modificaciones sin previo aviso. Declinamos toda responsabilidad derivada de la información proporcionada / Subject to modification, without previous warning. This information is supplied without liability / L'entreprise se réserve le droit de procéder à des modifications sans préavis. Nous déclinons toute responsabilité quant aux informations fournies / Мы оставляем за собой право на внесение изменений без предварительного уведомления. Мы снимаем с себя любую ответственность в отношении предоставленной информации / Önceden bildirilmeksizin değiştirilme hakkı saklıdır. Verilen bilgiler için hiçbir sorumluluk kabul etmemekteyiz / حقوق التغيير محفوظة دون إشعار مسبق. دون أدنى مسؤولية عن المعلومات المقدمة

	TD (kg)	Cargas máximas / Maximum loads / Charges maximales / Максимальные нагрузки / Maksimum yük / أقصى حمولة TD -9000 kg							9000 kg
	Alcance del gancho [m] / Hook reach [m] / Portée du crochet (m) / Радиус действия крюка (m) / Kancanın yüksekliği (m) / مدى الخطاف							@ (m)	
	60	55	50	45	40	35	30	25	
60 m	3200	4285	5545	7065	8950	9000	9000	9000	39,9
55 m	---	4500	5770	7270	9000	9000	9000	9000	40,3
50 m	---	---	5900	7415	9000	9000	9000	9000	40,6
45 m	---	---	---	7600	9000	9000	9000	9000	41,1
40 m	---	---	---	---	9000	9000	9000	9000	40,0
35 m	---	---	---	---	---	9000	9000	9000	35,0
30 m	---	---	---	---	---	---	9000	9000	30,0

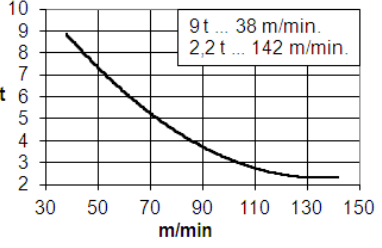
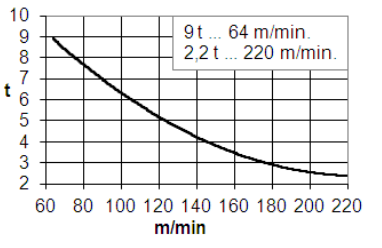
	TD/2R (kg)	Cargas máximas / Maximum loads / Charges maximales / Максимальные нагрузки / Maksimum yük / أقصى حمولة TD/2R – 9000/18000 kg							9000 18000
	Alcance del gancho [m] / Hook reach [m] / Portée du crochet (m) / Радиус действия крюка (m) / Kancanın yüksekliği (m) / مدى الخطاف							@ (m)	
	60	55	50	45	40	35	30	25	
60 m	3000	4090	5365	6895	8795	9000 11215	9000 14435	9000 18000	39,5 25,9
55 m	---	4300	5580	7090	8960	9000 11345	9000 14505	9000 18000	39,9 25,9
50 m	---	---	5700	7225	9000 9085	9000 11445	9000 14570	9000 18000	40,2 25,9
45 m	---	---	---	7400	9000 9265	9000 11600	9000 14685	9000 18000	40,7 26,0
40 m	---	---	---	---	9000 9400	9000 11730	9000 14770	9000 18000	40,0 26,0
35 m	---	---	---	---	---	9000 11800	9000 14835	9000 18000	35,0 26,0
30 m	---	---	---	---	---	---	9000 15000	9000 18000	30,0 26,2

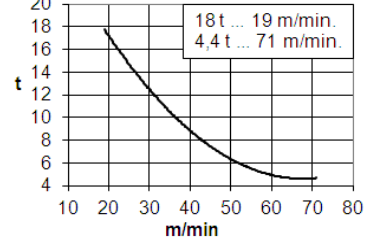
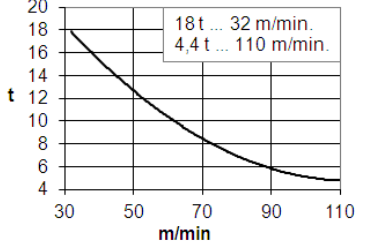
CARACTERÍSTICAS DE MECANISMOS / MECHANISMS FEATURES / CARACTÉRISTIQUES

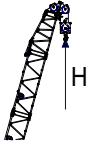
DES MÉCANISMES / ХАРАКТЕРИСТИКИ МЕХАНИЗМОВ / MEKANİZMALARIN ÖZELLİKLERİ / الخصائص الآلية

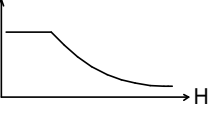
*opcional *optional *en option *опция *opsiyonel *اختياري						
	EC8871VF 65 kW	* EC150110VF 110 kW	TG4025VF 4x7,5 kW	OG2008VF 2x7,3 kW	EP10015VF 75 kW	TH4010 29,4 kW
			0...25 m/min	0...0,2 0,2...0,4 0,4...0,8 r/min	1,5 min	0,6 m/min
			 400V 50Hz P_{TOTAL}(EC8871VF + OG2008VF + EP10015VF) = 154,6 kW P_{TOTAL}(*EC150110VF + OG2008VF + EP10015VF) = *199,6 kW			
	H ≤ TD 2R	818 m 409 m				



JASO EQUIPOS DE OBRAS Y CONSTRUCCIONES, S.L.



FEM 1005 – C25

Reservado el derecho a modificaciones sin previo aviso. Declinamos toda responsabilidad derivada de la información proporcionada / Subject to modification, without previous warning. This information is supplied without liability / L'entreprise se réserve le droit de procéder à des modifications sans préavis. Nous déclinons toute responsabilité quant aux informations fournies / Мы оставляем за собой право на внесение изменений без предварительного уведомления. Мы снимаем с себя любую ответственность в отношении предоставленной информации / Önceden bildirilmeksizin değiştirilme hakkı saklıdır. Verilen bilgiler için hiçbir sorumluluk kabul etmemekteyiz / حقوق التغيير محفوظة دون إشعار مسبق. دون أدنى مسؤولية عن المعلومات المقدمة

LISTA DE EMBARQUE / PACKING LIST

J280PA.2R

LISTE DE COLISAGE / СПИСОК ПОСТАВКИ / ÇEKİ LİSTESİ / قائمة التحميل

DENOMINACIÓN / DENOMINATION / DÉSIGNATION / НАЗВАНИЕ / AÇIKLAMA / اسم		L [m]	A [m]	H [m]	P / W [kg]
Torre inferior / Lower tower / Tour inférieure / Нижняя башня / Alt kule / البرج السفلي	TSRI-20-5,6				
		5,990	2,257	2,257	6562
Torre / Tower / Tour	TSR20				
Башня / Kule / برج	TSR20-5,6				
		4,260	2,251	2,251	3110
		5,990	2,257	2,257	4262
Torre asiento pista, torre superior y orientación / Slewing table, top tower and slewing mechanism / Tour pivot + tour supérieure + mécanisme d'orientation / Сиденье площадки + верхняя башня + поворотный механизм / Göbek üst kule+mekanizma / برج وحدة الدوران + البرج العلوي + آلية الدوران					
		8,760	2,315	2,530	13150
Tramo de pluma / Jib section / Tronçon de flèche / Секция стрелы / Bom bölümü / أجزاء الذراع	[I] [II] [III] [IV] [V] [VI] [VII] [VIII] [IX]				
		6,265	2,140	1,715	1500
		5,525	1,580	1,725	1120
		10,485	1,580	1,725	2015
		10,485	1,580	1,725	1856
		10,485	1,580	1,725	1680
		10,485	1,580	1,725	1450
		5,575	1,580	1,725	810
		3,695	1,580	1,830	865
		1,155	1,580	1,950	680
Contrapluma con mecanismos, pasteca y plumin / Counterjib with mechanisms, reeving block and auxiliary jib / Contre-flèche avec mécanismes et fléchette auxiliaire / Противовесная консоль с механизмами и вспомогательной дополнительной стрелой / Mekanizmalı kuiruk ve yardımcı kol uzantısı / الذراع المعاكس مع آليات وريشة مساعدة					
		7,150	2,200	2,470	19112
Contrapluma con elevacion pluma, pasteca y plumin / Counterjib with luffing mechanisms, reeving block and auxiliary jib / Contre-flèche avec mécanisme de relevage de la flèche, moufle et fléchette / Противовесная консоль с механизмом подъема стрелы, блоком и дополнительной стрелой / Kaldırma kollu, makara düzenekli ve kol uzantılı kuiruk / الذراع المعاكس مع رافع الذراع والبكرة والريشة الإضافية					
		7,150	2,200	2,470	10570
Mecanismo elevacion carga / Hoisting mechanism / Mécanisme de levage de charge / Подъем груза / Yük kaldırma / رافع الحمولة					
		2,400	2,135	2,075	8542
Polipasto / Hook assembly / Palan / Полуснаст / Kanca takımı / بكرة	2R/TD TD				
		0,960	0,235	1,610	480
		0,140	0,160	1,662	192
Tirante sostén pluma / Jib support tie / Tirant de fleche / Растяжка поддержки стрелы / Kol destek bağları / مشد دعامة الذراع					
		5,830	0,430	0,480	2095
Parte superior / Top part					
		11,900	2,200	0,860	5380
Plataforma y cabina (2 x 1,5) / Platform and cabin / Plateforme et cabine / Платформа и кабина / Platform ve kabin / منصة وكابينة					
		4,000	1,905	2,335	1190
Transporte torre de montaje/ Jacking cage transport / Transport de tour de montage / Транспортировка монтажной башни / Kaldırma kafesinin taşınması / نقل برج التركيب	TM20PASR-5,6				
		10,820	2,285	2,395	12140
Contrapeso / Counterweight / Contrepoids / Противовес / Denge ağırlığı / اوزان معاكسة					
		4,500	0,235	0,800	6000
Contrapeso / Counterweight / Contrepoids / Противовес / Denge ağırlığı / اوزان معاكسة	Lastre / Ballast / Lest / Балласт / Alt ağırlık taşları / ثقل				
		3,8	0,58	1,5	6000



JASO EQUIPOS DE OBRAS Y CONSTRUCCIONES, S.L.



FEM 1005 – C25

Reservado el derecho a modificaciones sin previo aviso. Declinamos toda responsabilidad derivada de la información proporcionada / Subject to modification, without previous warning. This information is supplied without liability / L'entreprise se réserve le droit de procéder à des modifications sans préavis. Nous déclinons toute responsabilité quant aux informations fournies / Мы оставляем за собой право на внесение изменений без предварительного уведомления. Мы снимаем с себя любую ответственность в отношении предоставленной информации / Önceden bildirilmeksizin değiştirilme hakkı saklıdır. Verilen bilgiler için hiçbir sorumluluk kabul etmemekteyiz / حقوق التغيير محفوظة دون إشعار مسبق. دون أدنى مسؤولية عن المعلومات المقدمة

Fecha / Date: 26-09-2014

1	5,9	TSR 20-5,6	TSR 20	4,2	1	3,87	5,9	1	3,87	4,2	1	TSR 20	TSR 20-5,6	5,9	1
2	11,5		TSR 20-5,6	9,8	2		11,5	2		9,8	2			11,5	2
3	17,1			15,4	3	5,6	17,1	3		15,4	3			17,1	3
4	22,7			21	4		22,7	4		21	4			22,7	4
5	28,3			26,6	5		28,3	5		26,6	5			28,3	5
6	33,9			32,2	6		33,9	6		32,2	6			33,9	6
7	40,7		TR 24/TSR20 TR 24-5,6 TRD 24-5,6	37,8	7		40,7	7	1,24	37,8	7	TR 24/TSR20 TR 24-5,6 TRD 24-5,6		40,7	7
8	46,3			44,6	8		46,3	8		44,6	8			46,3	8
9	51,9			50,2	9		51,9	9		50,2	9			51,9	9
				55,8	10		57,5	10		61,4	11			63,1	11

AR24 156.21.200
TR24/TSR20 204.36.000
TR24-5,6 156.30.700
TRD24-5,6 163.31.300

T: Torre / Tower / Tour / Башни / Kuleler / أبراج
H: Altura / Height / Hauteur / Высота / Yükseklik / ارتفاع

Otras configuraciones de torre / Other tower configuration / Autres configurations / Прочие конфигурации / Diğer konfigürasyonlar / مكونات أخرى

Transporte / Transport / Transport / Транспортировка / Taşıma / نقل

H=44,6 m + + BSRI 8-20-5,6H

8x

9x HIGH CUBE 40'

TREPADO / CLIMBING / TÉLESCOPAGE / ЛЕСТНИЦА / TIRMANMA / التسلق **J280PA.2R**

$h_{max}: \text{TSR20-5,6T} + 7 \times \text{TSR20-5,6}$

	▶	■
h (m)	44,8	
D (m)	17 - 21	
P (KN)	1550	1370
Rmax (KN)	382	735

TSR20-5,6T: 204.31.700

Trepado interno / Internal climbing. / Télescopage intérieur / Внутренняя лестница / Bina içi tırmanma / التسلق الداخلي

Viento fuera de servicio / Out of service wind / Vitesse du vent hors service / Ветровая нагрузка в покое / Rüzgar devre dışı / الريح خارج الخدمة

Consultar / Consult / Nous consulter / Консультируйтесь / Danışınız / الرجوع إلى

▶ En servicio / In service / En service / В работе / Devrede / في الخدمة

■ Fuera de servicio / Out of service / Hors service / В покое / Devre dışı / خارج الخدمة

Fecha / Date: 26-09-2014

JASO EQUIPOS DE OBRAS Y CONSTRUCCIONES, S.L.

Ctra./Rd. Madrid - Irún Km. 415
20.213 IDIAZABAL [Gipuzkoa]
ESPAÑA / SPAIN
P.O. Box, 23 - 20.200 BEASAIN

Tel. +34 943 - 18 70 00
Fax. +34 943 - 18 70 20
E-mail: jaso@jaso.com
http://www.jaso.com

FEM 1005 – C25

DELEGACION / DELEGATION

Reservado el derecho a modificaciones sin previo aviso. Declinamos toda responsabilidad derivada de la información proporcionada / Subject to modification, without previous warning. This information is supplied without liability / L'entreprise se réserve le droit de procéder à des modifications sans préavis. Nous déclinons toute responsabilité quant aux informations fournies / Мы оставляем за собой право на внесение изменений без предварительного уведомления. Мы снимаем с себя любую ответственность в отношении предоставленной информации / Önceden bildirilmeksizin değiştirilme hakkı saklıdır. Verilen bilgiler için hiçbir sorumluluk kabul etmemekteyiz / حقوق التغيير محفوظة دون إشعار مسبق. دون أدنى مسؤولية عن المعلومات المقدمة