

TRUCK CRANE

TG-1600M

TG

JAPANESE SPECIFICATIONS

CARRIER MODEL	OUTLINE	SPEC. NO.
NISSAN DIESEL W-KG620WN	3-stage Luffing Jib	TG-1600M-4-10103
mitsubishi W-KA904U		TG-1600M-4-20103

Control No. JA-02

TG-1600M

CRANE SPECIFICATIONS

CRANE CAPACITY

12.5m	Boom	160,000kg	at 3.3m	(20 part-line)
17.5m	Boom	100,000kg	at 6.0m	(12 part-line)
25.6m	Boom	70,000kg	at 7.0m	(9 part-line)
33.7m	Boom	65,000kg	at 6.0m	(7 part-line)
41.9m	Boom	45,000kg	at 9.0m	(5 part-line)
46.0m	Boom	32,000kg	at 11.0m	(4 part-line)
50.0m	Boom	27,000kg	at 12.0m	(4 part-line)
11.3m	Jib	16,000kg	at 77°	(2 part-line)
6.2m + 13.3m	Jib	8,000kg	at 80°	(1 part-line)
6.2m + 21.3m	Jib	5,000kg	at 80°	(1 part-line)
Single top		8,500kg		(1 part-line)

MAX. LIFTING HEIGHT

Boom	51.0m
Jib	76.0m

MAX. WORKING RADIUS

Boom	47.0m
Jib	57.5m

BOOM LENGTH

17.5m – 50.0m
12.5m – 45.0m

BOOM EXTENSION

32.5m

BOOM EXTENSION SPEED

32.5m / 195s

JIB LENGTH

11.3m, 6.2m + 13.3m, 6.2m + 21.3m

MAIN WINCH SINGLE LINE SPEED

135m/min (6th layer)

MAIN WINCH HOOK SPEED

11.25m/min (12 part-line)

AUXILIARY WINCH SINGLE LINE SPEED

112m/min (5th layer)

AUXILIARY WINCH HOOK SPEED

112m/min (1 part-line)

BOOM ELEVATION ANGLE

-1.5° – 83°

BOOM ELEVATION SPEED

-1.5° – 83° / 80s

SWING ANGLE

360° continue

SWING SPEED

1.6 rpm

WIRE ROPE

Main Winch

25mm × 310m (Diameter×Length)
Spin-resistant wire rope

Auxiliary Winch

22mm × 250m (Diameter×Length)
Spin-resistant wire rope

HOOK

160t hook	(20part-line)
65t hook	(7part-line)
25t hook	(3part-line)
8.5t hook	(1part-line)

BOOM

5-section hydraulically telescoping boom of box construction.

(stages 2–4: synchronized; stage 5: sequenced)

BOOM EXTENSION

4 double-acting hydraulic cylinder

JIB

3-staged swingaround boom extensions.

(with 2nd and 3rd stages being of a pull-out type)

Offset

11.3m Jib	0°
6.2m + 13.3m Jib and 6.2m + 21.3m Jib	...	10°, 20°, 30°, 40°, 50°

SINGLE TOP

Single sheave. Mounted to main boom head by pin.

HOIST

Driven by hydraulic motor and via planetary gear reducer

Automatic brake

2-speed (High/Low) selection type

2 single winches

With flow regulator valve with pressure compensation

BOOM ELEVATION

2 double-acting hydraulic cylinders

SWING

Hydraulic motor driven planetary gear reducer

Swing bearing

Hand brake

Swing free/lock changeover type

OUTRIGGERS

Fully hydraulic H-type

Slides and jacks each provided with independent operation device.

Full extended width 8.0m

Middle extended width 6.0m

Extended width detector

MAX. OUTRIGGER LOAD

115t

FRONT JACK

Hydraulic operated type

Ground contact detector

REAR JACK

Hydraulic type (with cylinder for extension)

Ground contact detector

Individual operation type

ENGINE FOR CRANE

Model NISSAN DIESEL PE6T

Type 4-cycle, 6 in-line cylinder, direct-injection, water-cooled diesel engine.

Piston Displacement 11,670cc

Max. Output 250PS at 1,800rpm

Max. Torque 106kg·m at 1,200rpm

HYDRAULIC PUMPS

2 variable piston pumps and 2 variable gear pumps

HYDRAULIC OIL TANK CAPACITY

Upper 2,000 liters

Lower 120 liters

SAFETY DEVICES

Automatic moment limiter (AML)

With working range function

Over-winding cutout

Level gauge

Outrigger extension width detector

Front jack ground contact detector

Rear jack ground contact detector

Weight combination detector

Dead winding holding device (main winch only)

Working area control device

Hook safety latch

Cable follower

Winch drum lock

Hydraulic safety valve

Telescopic counterbalance valve

Elevation counterbalance valve

Jack pilot check valve

Luffing cylinder holding valve

Swing lock

Front jack over load alarm

EQUIPMENTS

Crane cab heater

Crane cab cooler

Oil cooler

Boom angle indicator

Winch drum rotation indicator

Rear jack extended device

Boom dismount device

Swing frame dismount device

Counterweight dismount device

Radio

Fan

OPTIONAL EQUIPMENT

Luffing Jib

Jib length 20m, 29m, 38m

With anemometer

CARRIER SPECIFICATIONS

MANUFACTURER

NISSAN DIESEL MOTOR CO., LTD

CARRIER MODEL

W-KG620WN

ENGINE

Model RF10

Type 4-cycle V10-cylinder, direct-injection, water-cooled diesel engine

Piston displacement 21,239cc

Max. output 420PS at 2,200rpm

Max. torque 142kg·m at 1,400rpm

CLUTCH

Dry multi-plate coil spring type

TRANSMISSION

7-forward and 1-reverse speeds

Constant-mesh gear (2nd-7th speeds gears synchromeshed)

REDUCER

Hypoid gear type

Planetary gear hub reduction

FRONT AXLE

Reverse-elliot type steering knuckles

REAR AXLE

Full floating, cast torque rods

SUSPENSION

Front REYCO type (load-balanced semi-elliptic leaf spring type)

Rear Equalizer and torque rods

STEERING

Recirculating ball screw type

With linkage type hydraulic power booster

BRAKE SYSTEM

Service Brake

Foot operated full air brake on all wheels, dual air line system, internal expanding leading and trailing shoe type.

Parking Brake

Mechanically operated, internal expanding duo-servo shoe type acting on drum at transmission case rear.

Auxiliary Brake

Electro-pneumatic operated exhaust brake.

Emergency

Spring brake, acting on 4 rear wheels

ELECTRIC SYSTEM

24 V DC. 2 batteries of 12V- 115F51 (96Ah)

FUEL TANK CAPACITY

300 liters

CAB

Two-man type

TIRES

Front 14.00-24-24PR

Rear 14.00-24-24PR

STANDARD EQUIPMENTS

Car heater

Car radio

Car cooler

GENERAL DATA

DIMENSIONS (CARRIER ONLY)

Overall length 11,770mm

Overall width 3,400mm

Overall height 2,750mm

Wheel base 1,500mm + 4,300mm + 1,500mm = 7,300mm

Tread Front 2,830mm

Rear 2,540mm

WEIGHTS (CARRIER ONLY)

Gross vehicle weight

Total 37,040kg

Front 13,900kg

Rear 23,140kg

PERFORMANCE (CARRIER ONLY)

Max. traveling speed 65km/h

Gradeability (tan θ) 0.40

Min. turning radius 11.8m

CARRIER SPECIFICATIONS

MANUFACTURER

MITSUBISHI MOTOR CORPORATION

CARRIER MODEL

W-KA904U

ENGINE

Model 10DC11

Type 4-cycle V10-cylinder, direct-injection, water-cooled diesel engine

Piston displacement 22,171cc

Max. output 440PS at 2,200rpm

Max. torque 156kg·m at 1,300rpm

CLUTCH

Dry multi-plate

TRANSMISSION

10-forward and 2-reverse speeds

Constant-mesh gear (1st speed.2nd speed.reverse)

Synchronized-mesh gear (3rd-10th speeds)

REDUCER

Hypoid gear type

Planetary gear hub reduction

FRONT AXLE

Reverse-elliot type steering knuckles

REAR AXLE

Full floating, cast torque rods

SUSPENSION

Front Tapered leaf spring

With torsion bar stabilizer

Rear Equalizer beam and torque rod type

STEERING

Recirculating ball screw type

With linkage type hydraulic power booster

BRAKE SYSTEM

Service Brake

Foot operated full air brake on all wheels, dual air line system, internal expanding leading and trailing shoe type.

Parking Brake

Mechanically operated, internal expanding duo-servo shoe type acting on drum at transmission case rear.

Auxiliary Brake

Electro-pneumatic operated exhaust brake.

Spring brake, acting on 4 rear wheels

ELECTRIC SYSTEM

24 V DC. 2 batteries of 12V-145G51 (120Ah)

FUEL TANK CAPACITY

400 liters

CAB

Two-man type

TIRES

Front 14.00-24-24PR

Rear 14.00-24-24PR

STANDARD EQUIPMENTS

Car heater

Car radio

Car cooler

GENERAL DATA

DIMENSIONS (CARRIER ONLY)

Overall length 12,180mm

Overall width 3,400mm

Overall height 3,140mm

Wheel base 1,550mm+4,325mm+1,500mm=7,375mm

Tread Front 2,760mm

Rear 2,520mm

WEIGHTS (CARRIER ONLY)

Gross vehicle weight

Total 38,340kg

Front 15,215kg

Rear 23,125kg

PERFORMANCE (CARRIER ONLY)

Max. traveling speed 60km/h

Gradeability (tan θ) 0.77

Min. turning radius 11.8m

TOTAL RATED LOADS

[50m BOOM] With 35t + 4,5t counterweight

Unit:ton

Outriggers fully extended + Front jack + Rear jack (360°)						
A \ B (m)	17.5m	25.6m	33.7m	41.9m	46.0m	50.0m
3.3	100.0					
3.5	100.0	70.0				
4.0	100.0	70.0				
4.5	100.0	70.0				
5.0	100.0	70.0	65.0			
5.5	100.0	70.0	65.0			
6.0	100.0	70.0	65.0	45.0		
6.5	91.0	70.0	64.0	45.0		
7.0	84.0	70.0	62.0	45.0	32.0	27.0
7.5	78.0	69.0	60.0	45.0	32.0	27.0
8.0	73.0	68.0	58.0	45.0	32.0	27.0
9.0	64.0	65.0	53.0	45.0	32.0	27.0
10.0	56.0	58.0	49.5	43.0	32.0	27.0
11.0	49.0	51.5	46.0	41.0	32.0	27.0
12.0	43.0	46.0	42.0	38.0	31.0	27.0
14.0	35.0	36.0	36.0	32.0	28.0	25.0
16.0		29.0	30.5	28.0	25.0	22.0
18.0		23.0	25.0	24.0	22.5	20.0
20.0		20.0	21.0	20.5	20.0	17.5
22.0		16.5	17.5	17.0	18.0	16.0
24.0			14.8	15.3	16.0	14.0
26.0			12.0	12.8	13.8	12.7
28.0			10.0	10.5	11.5	11.5
30.0			8.0	8.5	9.5	10.5
32.0				7.0	8.0	9.5
34.0				5.5	6.7	8.3
36.0				4.2	5.5	7.0
38.0				3.0	4.2	5.8
40.0					3.1	4.7
42.0					2.2	3.8
44.0						2.9
46.0						2.1
47.0						1.7

A = Boom length

B = Working radius

[50m BOOM] With 4.5t counterweight

Unit:ton

Outriggers fully extended + Front jack + Rear jack (360°)						
A \ B (m)	17.5m	25.6m	33.7m	41.9m	46.0m	50.0m
3.3	100.0					
3.5	100.0	70.0				
4.0	100.0	70.0				
4.5	100.0	70.0				
5.0	89.0	70.0	65.0			
5.5	79.0	70.0	65.0			
6.0	74.0	70.0	65.0	45.0		
6.5	67.0	70.0	62.0	45.0		
7.0	62.0	63.0	60.0	45.0	32.0	27.0
7.5	57.0	60.0	58.0	45.0	32.0	27.0
8.0	52.0	55.0	56.0	45.0	32.0	27.0
9.0	43.0	46.0	47.5	43.0	32.0	27.0
10.0	34.0	36.5	37.5	38.0	32.0	27.0
11.0	27.0	29.3	30.5	31.5	32.0	27.0
12.0	21.6	24.2	25.4	26.2	27.3	27.0
14.0	14.5	16.8	18.0	18.7	19.7	20.5
16.0		11.8	13.0	13.5	14.5	15.4
18.0		8.4	9.5	10.0	11.0	11.8
20.0		5.7	6.8	7.4	8.4	9.0
22.0		3.2	4.5	5.1	6.2	6.9
24.0			2.5	3.2	4.4	5.2
26.0					2.7	3.7
28.0						2.3

A = Boom length

B = Working radius

NOTES:

1. The total rated loads shown are for the case when the outriggers are set horizontally on firm ground. The values above the bold lines are based on the crane strength while those below are based on the crane stability.
2. The weights of the slings and hooks are included in the total rated loads shown.
3. The total rated load is based on the actual working radius including the deflection of the boom.
4. Crane operations are prohibited when the boom length is more than 12.5m and less than 17.5m.
5. The chart below shows the standard number of part lines for each boom length.

A	17.5m	25.6m	33.7m	41.9m	46.0m	50.0m	Single top
H	12	9	7	5	4		1
K	160t Hook		65t Hook				8.5t Hook
L	1,575kg		940kg				250kg

A = Boom length
 H = No. of part-line
 K = Hook type
 L = Hook weight

6. The total rated load for the single top is the same as that of the main boom and must not exceed 8.5 tons. However, when hooks, slings, etc. are mounted on the main boom, one should work with the total rated load obtained by subtracting the weights of the hooks, slings, etc. mounted on the main boom from the total rated load of the main boom.

[45m BOOM] With 35t + 4.5t counterweight Unit:ton

Outriggers fully extended + Front jack + Rear jack (360°)					
A B (m)	12.5 m	20.6 m	28.7 m	36.9 m	45.0 m
3.3	160.0				
3.5	145.0	70.0			
4.0	135.0	70.0			
4.5	125.0	70.0	55.0		
5.0	115.0	70.0	55.0		
5.5	107.0	70.0	55.0		
6.0	100.0	70.0	55.0	50.0	
6.5	91.0	70.0	55.0	50.0	
7.0	84.0	70.0	55.0	50.0	27.0
7.5	78.0	69.0	52.0	50.0	27.0
8.0	73.0	68.0	50.0	49.0	27.0
9.0	65.0	65.6	45.0	44.5	27.0
10.0	58.0	58.0	41.5	41.0	27.0
11.0		51.5	38.0	38.0	27.0
12.0		46.0	35.5	35.0	27.0
14.0		36.0	31.0	30.5	24.5
16.0		30.5	27.5	26.0	21.5
18.0		26.0	24.5	23.0	19.0
20.0			22.0	21.0	17.0
22.0			19.0	19.0	15.5
24.0			16.0	16.0	14.0
26.0			13.5	14.0	12.7
28.0				12.0	11.3
30.0				10.0	10.5
32.0				9.0	9.5
34.0				7.4	8.5
36.0					8.0
38.0					7.0
40.0					6.0
42.0					5.0

A = Boom length
 B = Working radius

[45m BOOM] With 35t counterweight

Unit:ton

Outriggers fully extended + Front jack + Rear jack (360°)		Outriggers middle extended (360°)				
		· Front jack not used (360°)				
		· Rear jack not used (360°)				
A B (m)		12.5 m	20.6 m	28.7 m	36.9 m	45.0 m
3.3	160.0					
3.5	145.0	70.0				
4.0	135.0	70.0				
4.5	125.0	70.0	55.0			
5.0	115.0	70.0	55.0			
5.5	107.0	70.0	55.0			
6.0	100.0	70.0	55.0	50.0		
6.5	91.0	70.0	55.0	50.0		
7.0	84.0	70.0	55.0	50.0		
7.5	78.0	69.0	52.0	50.0	27.0	
8.0	73.0	68.0	50.0	49.0	27.0	
9.0	65.0	65.6	45.0	44.5	27.0	
10.0	58.0	58.0	41.5	41.0	27.0	
11.0		51.5	38.0	38.0	27.0	
12.0		46.0	35.5	35.0	27.0	
14.0		36.0	31.0	30.5	24.5	
16.0		30.5	27.5	26.0	21.5	
18.0		25.0	24.5	23.0	19.0	
20.0			22.0	19.7	17.0	
22.0			18.0	18.5	15.5	
24.0			15.0	15.5	14.0	
26.0			12.6	13.0	12.7	
28.0				11.0	11.3	
30.0				9.3	10.5	
32.0				7.9	9.5	
34.0				6.4	8.2	
36.0					7.0	
38.0					6.0	
40.0					5.0	
42.0					4.1	

A = Boom length
B = Working radius

[45m BOOM] With 18t counterweight

Unit:ton

Outriggers fully extended + Front jack + Rear jack (360°)		Outriggers middle extended (360°)											
		· Front jack not used (360°) · Rear jack not used (360°)											
A	B (m)	12.5 m	20.6 m	28.7 m	36.9 m	45.0 m	A						
		B (m)							12.5 m	20.6 m	28.7 m	36.9 m	45.0 m
3.3	160.0						3.3	80.0					
3.5	145.0		70.0				3.5	80.0	70.0				
4.0	130.0		70.0				4.0	80.0	70.0				
4.5	115.0		70.0	55.0			4.5	80.0	70.0				
5.0	105.0		70.0	55.0			5.0	80.0	70.0	55.0			
5.5	95.0		70.0	55.0			5.5	74.0	65.0	55.0			
6.0	88.0		70.0	55.0	50.0		6.0	65.0	60.0	55.0	43.0		
6.5	80.0		70.0	55.0	50.0		6.5	56.0	56.0	55.0	43.0		
7.0	74.0		70.0	55.0	50.0	27.0	7.0	50.0	49.5	50.0	43.0	27.0	
7.5	68.5		69.0	52.0	50.0	27.0	7.5	44.0	44.0	45.0	43.0	27.0	
8.0	64.0		66.0	50.0	49.0	27.0	8.0	40.0	39.5	40.0	40.0	27.0	
9.0	57.0		57.0	45.0	44.5	27.0	9.0	32.0	32.0	33.0	33.0	27.0	
10.0	49.0		50.0	41.5	41.0	27.0	10.0	27.0	27.0	28.0	28.0	27.0	
11.0			45.5	38.0	38.0	27.0	11.0		22.5	23.0	23.0	25.0	
12.0			38.0	35.5	35.0	27.0	12.0		19.0	20.0	20.0	22.0	
14.0			28.0	29.0	29.5	24.5	14.0		14.0	14.5	15.0	16.5	
16.0			21.2	22.5	23.0	21.5	16.0		10.0	11.0	11.1	13.0	
18.0			16.3	17.5	18.0	19.0	18.0		6.9	8.0	8.5	10.0	
20.0				14.0	14.5	16.4	20.0			5.4	6.0	7.5	
22.0				11.0	11.5	13.4	22.0			3.3	3.9	5.8	
24.0				8.5	9.0	11.0	24.0			1.6	2.2	4.2	
26.0				6.8	7.5	9.2	26.0						
28.0					5.7	7.5							
30.0					4.1	6.4							
32.0					2.8	5.0							
34.0					1.6	3.9							
36.0						2.8							
38.0						1.9							
40.0						1.1							

A = Boom length

B = Working radius

[45m BOOM] With 4.5t counterweight

Unit:ton

Outriggers fully extended + Front jack + Rear jack (360°)					
A \ B (m)	12.5 m	20.6 m	28.7 m	36.9 m	45.0 m
3.3	100.0				
3.5	100.0	70.0			
4.0	100.0	70.0			
4.5	100.0	70.0	55.0		
5.0	87.0	70.0	55.0		
5.5	77.0	70.0	55.0		
6.0	72.0	70.0	55.0	50.0	
6.5	65.0	70.0	55.0	50.0	
7.0	60.0	70.0	55.0	50.0	27.0
7.5	55.0	63.0	52.0	50.0	27.0
8.0	52.0	58.0	50.0	49.0	27.0
9.0	47.0	50.0	45.0	44.5	27.0
10.0	37.0	40.0	40.0	40.6	27.0
11.0		32.5	33.5	33.5	27.0
12.0		27.2	28.0	28.2	27.0
14.0		19.5	20.3	20.5	22.0
16.0		14.0	15.0	15.3	17.2
18.0		10.3	11.3	11.7	13.4
20.0			8.3	8.5	10.5
22.0			6.2	6.5	8.3
24.0			4.2	4.6	6.5
26.0			2.5	3.0	5.1
28.0					3.7
30.0					2.5
32.0					1.4

A = Boom length

B = Working radius

[45m BOOM] With 0t counterweight

Unit:ton

· Outriggers fully extended + Front jack + Rear jack (360°)			· Outriggers middle extended (360°) · Front jack not used (360°) · Rear jack not used (360°)		
A B (m)	12.5 m	20.6 m	A B (m)	12.5 m	20.6 m
3.3	100.0		3.3	80.0	
3.5	100.0	70.0	3.5	80.0	70.0
4.0	100.0	70.0	4.0	80.0	70.0
4.5	100.0	70.0	4.5	70.0	70.0
5.0	87.0	70.0	5.0	54.0	54.0
5.5	77.0	70.0	5.5	46.0	46.0
6.0	72.0	70.0	6.0	40.0	40.0
6.5	65.0	65.0	6.5	34.5	34.5
7.0	60.0	60.0	7.0	30.0	30.0
7.5	55.0	55.0	7.5	26.0	26.0
8.0	52.0	52.0	8.0	23.0	23.0
9.0	41.0	41.0	9.0	18.0	18.0
10.0	32.0	32.0	10.0	14.5	14.5
11.0		26.0	11.0		10.5
12.0		21.0	12.0		8.0
14.0		15.0	14.0		5.0
16.0		10.0	16.0		2.0
18.0		7.0			

A = Boom length

B = Working radius

NOTES:

1. The total rated loads shown are for the case when the outriggers are set horizontally on firm ground. The values above the bold lines are based on the crane strength while those below are based on the crane stability.
2. The weights of the slings and hooks are included in the total rated loads shown.
3. The total rated load is based on the actual working radius including the deflection of the boom.
4. The chart below shows the standard number of part lines for each boom length.

A	12.5m		20.6m	28.7m	36.9m	45.0m	Single top
H	20	12	9	7	6	4	1
K	160t Hook (with auxiliary sheave)	160t Hook		65t Hook			8.5t Hook
L	2,185kg	1,575kg		940kg			250kg

A = Boom length
 H = No. of part-line
 K = Hook type
 L = Hook weight

5. The total rated load for the single top is the same as that of the main boom and must not exceed 8.5 tons. However, when hooks, slings, etc. are mounted on the main boom, one should work with the to rated load obtained by subtracting the weights of the hooks, slings, etc. mounted on the main boomtal from the total rated load of the main boom.

[3-STAGE LUFFING JIB] With 35t counterweight

C D	11.3 m		6.2 m + 13.3 m		6.2 m + 21.3 m		6.2 m + 21.3 m		6.2 m + 21.3 m		6.2 m + 21.3 m		6.2 m + 21.3 m		6.2 m + 21.3 m		Unit:ton								
	0°		10°		20°		30°		40°		50°		10°		20°			30°		40°		50°			
	B (m)	M	B (m)	M	B (m)	M	B (m)	M	B (m)	M	B (m)	M	B (m)	M	B (m)	M		B (m)	M	B (m)	M	B (m)	M	B (m)	M
E	10.8	16.0	15.1	8.0	17.1	6.0	18.9	5.0	20.4	4.5	21.6	4.0	17.9	5.0	21.3	3.6	24.2	3.0	26.7	2.5	28.6	2.2	29.8	2.2	
80	12.0	16.0	16.3	7.5	18.3	5.7	20.1	5.0	21.6	4.4	22.7	4.0	19.3	4.8	22.6	3.5	25.5	2.9	27.9	2.5	29.8	2.2	30.9	2.2	
79	13.2	16.0	17.5	7.0	19.5	5.5	21.2	4.9	22.7	4.3	23.8	3.8	20.7	4.6	23.9	3.4	26.7	2.8	29.1	2.4	30.9	2.2	32.1	2.2	
78	14.3	16.0	18.7	6.7	20.7	5.2	22.4	4.7	23.8	4.2	24.9	3.7	22.1	4.5	25.3	3.3	28.1	2.7	30.3	2.4	32.1	2.2	34.4	2.1	
77	16.5	14.5	21.2	6.2	23.1	5.0	24.7	4.6	26.1	4.0	27.0	3.6	24.8	4.1	27.9	3.2	30.6	2.6	32.8	2.3	34.4	2.1	37.6	2.1	
75	19.6	12.3	24.8	5.8	26.6	4.7	28.1	4.3	29.3	3.8	30.2	3.5	28.8	3.8	31.7	3.0	34.3	2.5	36.2	2.2	37.6	2.1	41.9	2.0	
72	21.7	11.1	27.1	5.6	28.8	4.5	30.3	4.1	31.5	3.7	32.2	3.4	31.4	3.6	34.3	2.9	36.6	2.4	38.5	2.2	39.8	2.0	44.9	1.9	
70	23.5	10.0	29.4	5.3	31.1	4.4	32.5	3.9	33.5	3.5	34.2	3.3	33.9	3.4	36.7	2.7	38.9	2.3	40.7	2.1	41.9	2.0	47.8	1.9	
68	26.4	8.5	32.9	5.1	34.4	4.3	35.6	3.7	36.6	3.4	37.1	3.2	37.6	3.1	40.3	2.6	42.4	2.2	43.9	2.0	44.9	1.9	51.4	1.8	
62	29.2	7.2	36.0	4.5	37.5	3.9	38.7	3.5	39.5	3.3	39.9	3.1	41.2	2.9	43.7	2.4	45.6	2.0	46.9	1.9	47.8	1.9	53.9	1.7	
60	31.1	6.5	38.1	4.1	39.5	3.8	40.6	3.4	41.4	3.2	41.7	3.0	43.5	2.7	45.9	2.3	47.8	1.95	49.0	1.8	49.6	1.8	56.2	1.3	
58	32.9	5.9	40.1	3.7	41.5	3.5	42.5	3.1	43.2	3.0	43.4	2.8	45.8	2.6	48.1	2.2	49.7	1.9	50.9	1.8	51.4	1.8	57.5	0.9	
55	35.4	4.4	43.0	3.2	44.3	3.1	45.2	2.8	45.7	2.7	45.9	2.7	49.1	2.4	51.2	2.1	52.7	1.8	53.6	1.75	53.9	1.7	59.9	0.9	
52	37.8	3.0	45.8	2.2	46.9	2.1	47.7	2.0	48.1	2.0	48.2	2.0	52.2	1.6	54.1	1.5	55.4	1.4	56.1	1.3	56.2	1.3	61.9	0.9	
50	39.4	2.25	47.2	1.6	48.4	1.5	49.2	1.4	49.6	1.4	49.5	1.3	55.6	1.1	55.6	1.0	56.9	1.0	57.5	0.9	57.5	0.9	64.9	0.9	
48	40.9	1.6																							

NOTES:
B = Working radius C = Jib length D = Jib offset E = Boom angle M = Total rated loads

- The total rated loads shown are for the case when the outriggers are set horizontally on firm ground. The values above the bold lines are based on the crane strength while those below are based on the crane stability.
- The weights of the slings and hooks are included in the total rated loads shown.
- The working radii in the above chart are reference values for the case when a jib is mounted on a 50m boom. Jib operations should be performed on the basis of the boom angle.
- The chart below shows the standard number of part lines for the hook for each jib length.

A	11.3 m	6.2 m + 13.3 m	6.2 m + 21.3 m
H	2		1
K	25t Hook		8.5t Hook
L	450 kg		250 kg

A = Jib length
H = No. of part-line
K = Hook type
L = Hook weight

[3-STAGE LUFFING JIB] With 18t counterweight

Unit:ton

C D	11.3 m		6.2 m + 13.3 m		6.2 m + 13.3 m		6.2 m + 21.3 m		6.2 m + 21.3 m		6.2 m + 21.3 m		6.2 m + 21.3 m		6.2 m + 21.3 m							
	0°	10°	20°	30°	40°	50°	10°	20°	30°	40°	50°	10°	20°	30°	40°	50°						
E (°)	B (m)	M	B (m)	M	B (m)	M	B (m)	M	B (m)	M	B (m)	M	B (m)	M	B (m)	M	B (m)	M				
80	10.8	16.0	15.1	8.0	17.1	6.0	18.9	5.0	20.4	4.5	21.6	4.0	17.9	5.0	21.3	3.6	24.2	3.0	26.7	2.5	28.6	2.2
79	12.0	16.0	16.3	7.5	18.3	5.7	20.1	5.0	21.6	4.4	22.7	4.0	19.3	4.8	22.6	3.5	25.5	2.9	27.9	2.5	29.8	2.2
78	13.2	16.0	17.5	7.0	19.5	5.5	21.2	4.9	22.7	4.3	23.8	3.8	20.7	4.6	23.9	3.4	26.7	2.8	29.1	2.4	30.9	2.2
77	14.3	16.0	18.7	6.7	20.7	5.2	22.4	4.7	23.8	4.2	24.9	3.7	22.1	4.5	25.3	3.3	28.1	2.7	30.3	2.4	32.1	2.2
75	16.5	14.5	21.2	6.2	23.1	5.0	24.7	4.6	26.1	4.0	27.0	3.6	24.8	4.1	27.9	3.2	30.6	2.6	32.8	2.3	34.4	2.1
72	19.6	12.3	24.8	5.8	26.6	4.7	28.1	4.3	29.3	3.8	30.2	3.5	28.8	3.8	31.7	3.0	34.3	2.5	36.2	2.2	37.6	2.1
70	21.7	11.1	27.1	5.6	28.8	4.5	30.3	4.1	31.5	3.7	32.2	3.4	31.4	3.6	34.3	2.9	36.6	2.4	38.5	2.2	39.8	2.0
68	23.3	9.0	29.4	5.3	31.1	4.4	32.5	3.9	33.5	3.5	34.2	3.3	33.9	3.4	36.7	2.7	38.9	2.3	40.7	2.1	41.9	2.0
65	26.1	6.0	32.7	4.5	34.4	4.3	35.6	3.7	36.6	3.4	37.1	3.2	37.6	3.1	40.3	2.6	42.4	2.2	43.9	2.0	44.9	1.9
62	28.8	3.8	35.6	2.8	37.2	2.6	38.5	2.5	39.3	2.5	39.8	2.2	40.9	2.0	43.5	1.7	45.5	1.7	46.8	1.5	47.7	1.5
60	30.5	2.7																				
58	32.3	1.6																				

B = Working radius C = Jib length D = Jib offset E = Boom angle M = Total rated loads

NOTES:

1. The total rated loads shown are for the case when the outriggers are set horizontally on firm ground. The values above the bold lines are based on the crane strength while those below are based on the crane stability.
2. The weights of the slings and hooks are included in the total rated loads shown.
3. The working radii in the above chart are reference values for the case when a jib is mounted on a 50m boom. Jib operations should be performed on the basis of the boom angle.
4. The chart below shows the standard number of part lines for the hook for each jib length.

A	11.3 m	6.2 m+13.3 m	6.2 m+21.3 m
H	2	1	
K	25t Hook	8.5t Hook	
L	450 kg	250 kg	

A = Jib length
H = No. of part-line
K = Hook type
L = Hook weight

[3-STAGE LUFFING JIB] With 4.5t counterweight

E (°)	Outriggers fully extended + Front jack + Rear jack (360°)												Unit: ton									
	11.3 m		6.2 m + 13.3 m		6.2 m + 13.3 m		6.2 m + 21.3 m		6.2 m + 21.3 m		6.2 m + 21.3 m											
	B (m)	M	B (m)	M	B (m)	M	B (m)	M	B (m)	M	B (m)	M										
80	10.3	13.0	15.1	8.0	17.1	6.0	18.9	5.0	20.4	4.5	21.6	4.0	17.9	5.0	21.3	3.6	24.2	3.0	26.7	2.5	28.6	2.2
79	11.4	11.5	16.3	7.5	18.3	5.7	20.1	5.0	21.6	4.4	22.7	4.0	19.3	4.8	22.6	3.5	25.5	2.9	27.9	2.5	29.8	2.2
78	12.4	9.5	17.5	7.0	19.5	5.5	21.2	4.9	22.7	4.3	23.8	3.8	20.7	4.6	23.9	3.4	26.7	2.8	29.1	2.4	30.9	2.2
77	13.3	8.3	18.7	6.7	20.7	5.2	22.4	4.7	23.8	4.2	24.9	3.7	22.1	4.5	25.3	3.3	28.1	2.7	30.3	2.4	32.1	2.2
75	15.5	6.0	21.2	5.8	23.1	4.8	24.7	4.5	26.1	4.0	27.0	3.6	24.8	4.1	27.9	3.2	30.6	2.6	32.8	2.3	34.4	2.1
72	18.5	3.8	24.4	3.6	26.3	3.0	27.9	2.9	29.1	2.7	30.0	2.5	28.8	3.8	31.7	3.0	34.3	2.5	36.2	2.2	37.6	2.1

B = Working radius C = Jib length D = Jib offset E = Boom angle M = Total rated loads

NOTES:

1. The total rated loads shown are for the case when the outriggers are set horizontally on firm ground. The values above the bold lines are based on the crane strength while those below are based on the crane stability.
2. The weights of the slings and hooks are included in the total rated loads shown.
3. The working radii in the above chart are reference values for the case when a jib is mounted on a 50m boom. Jib operations should be performed on the basis of the boom angle.
4. The chart below shows the standard number of part lines for the hook for each jib length.

A	11.3 m	6.2 m + 13.3 m	6.2 m + 21.3 m
H	2	1	1
K	25t Hook	8.5t Hook	
L	450 kg	250 kg	

A = Jib length
 H = No. of part-line
 K = Hook type
 L = Hook weight

WORKING RADIUS - LIFTING HEIGHT

[50m BOOM] With 35t + 4.5t counterweight

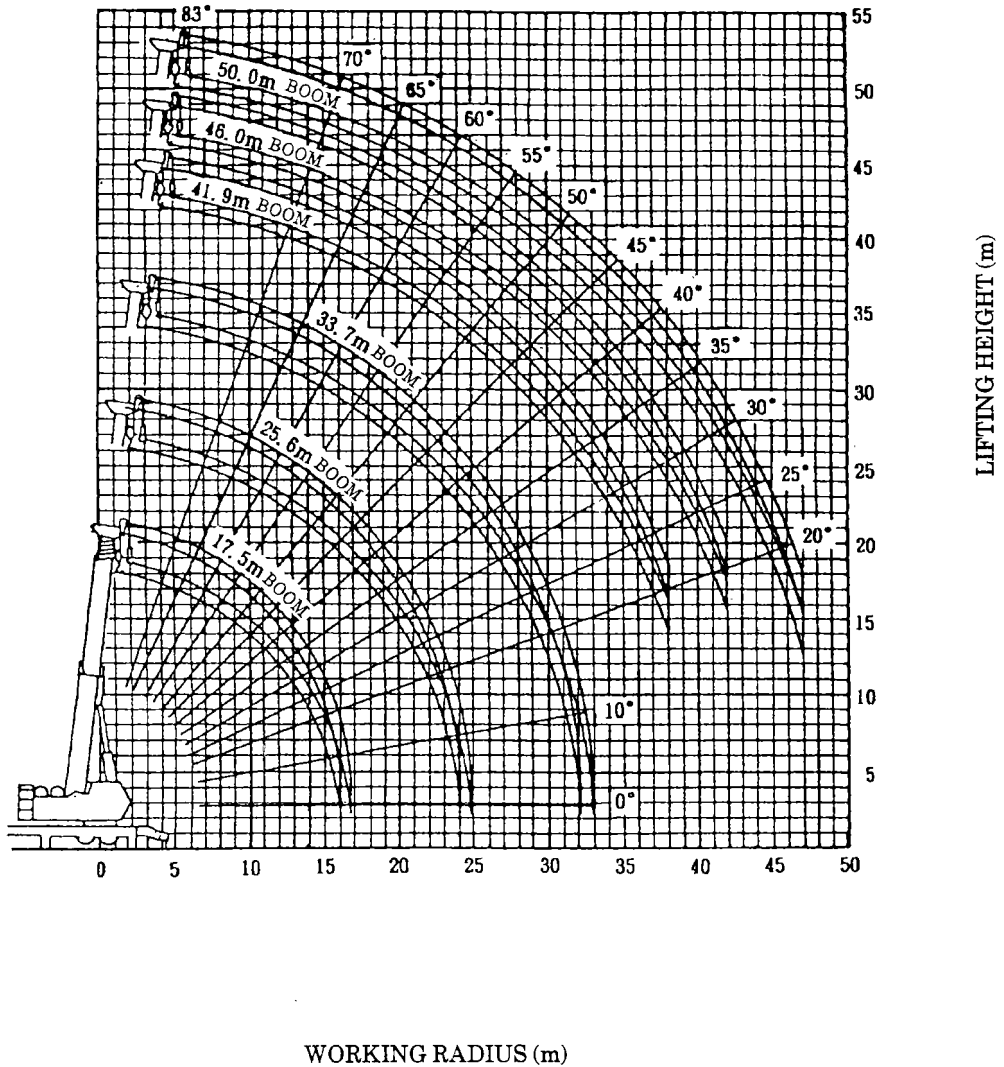

NOTES:

1. The deflection of the boom is not incorporated in the figure above.
2. The above chart is for the case where the outriggers are fully extended and where the front and rear jacks are used (over 360°)

[50m BOOM 3-STAGE LUFFING JIB] With 35t counterweight

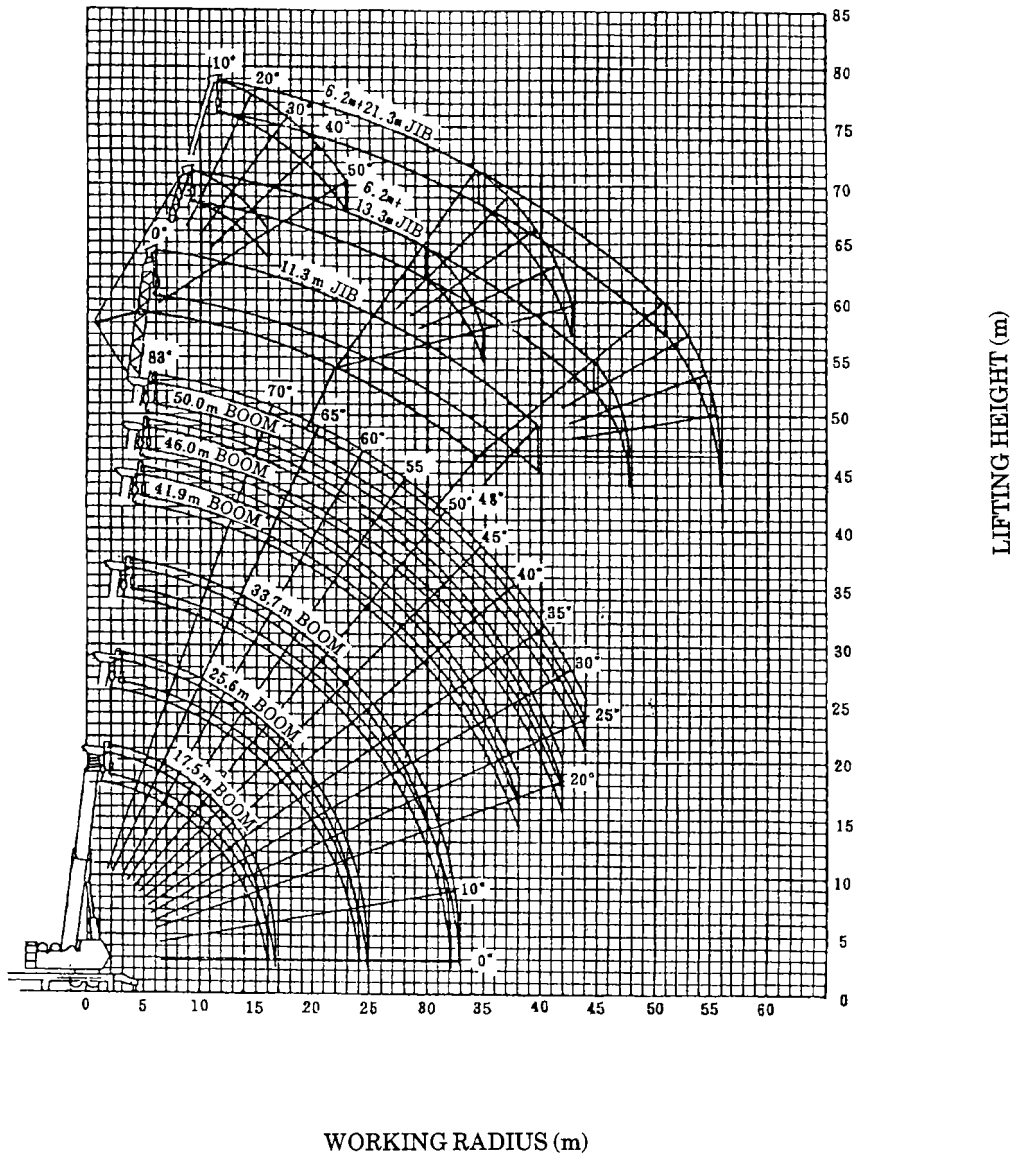

NOTES:

1. The deflection of the boom is not incorporated in the figure above.
2. The above chart is for the case where the outriggers are fully extended and where the front and rear jacks are used (over 360°)

[50m BOOM 3-STAGE LUFFING JIB] With 18t counterweight

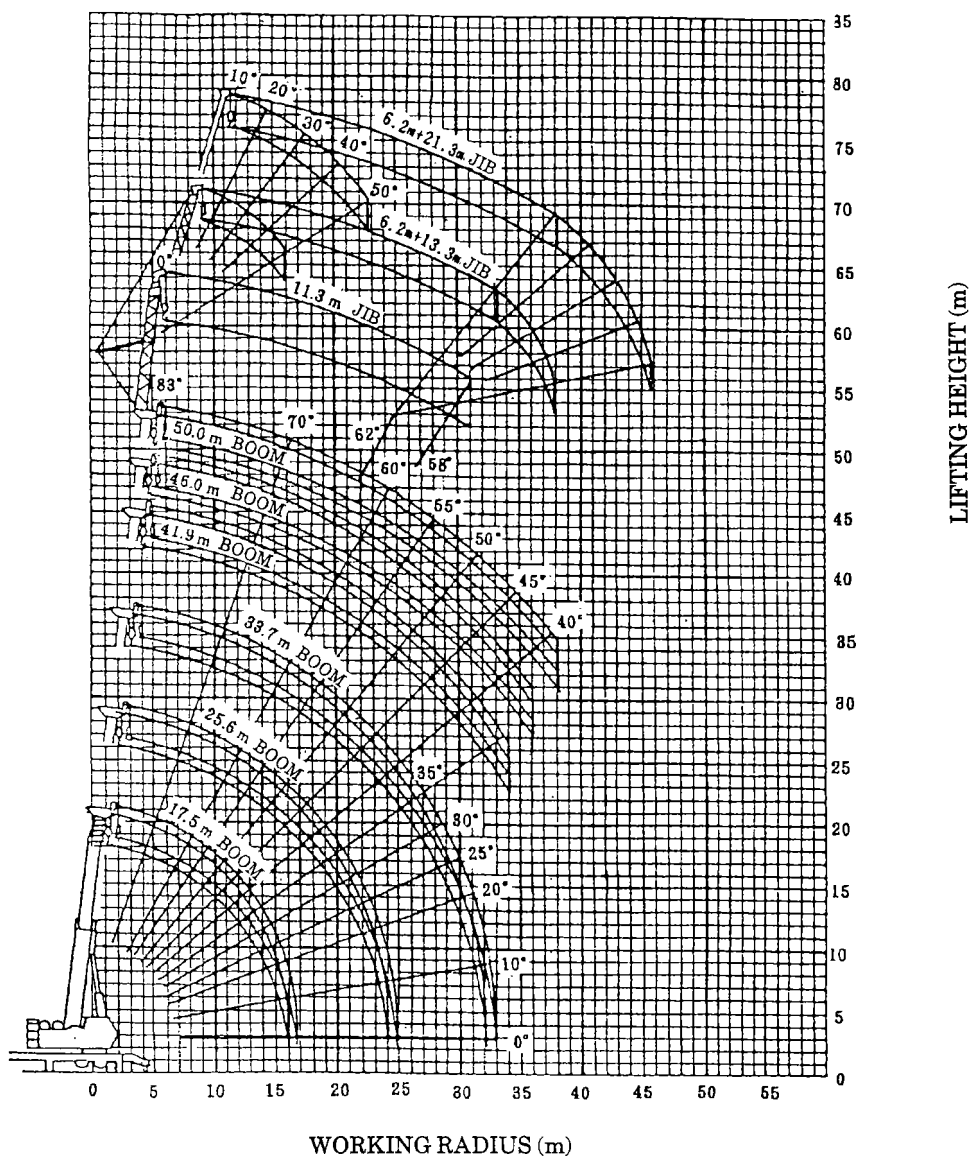

NOTES:

1. The deflection of the boom is not incorporated in the figure above.
2. The above chart is for the case where the outriggers are fully extended and where the front and rear jacks are used (over 360°)

[50m BOOM 3-STAGE LUFFING JIB] With 4.5t counterweight

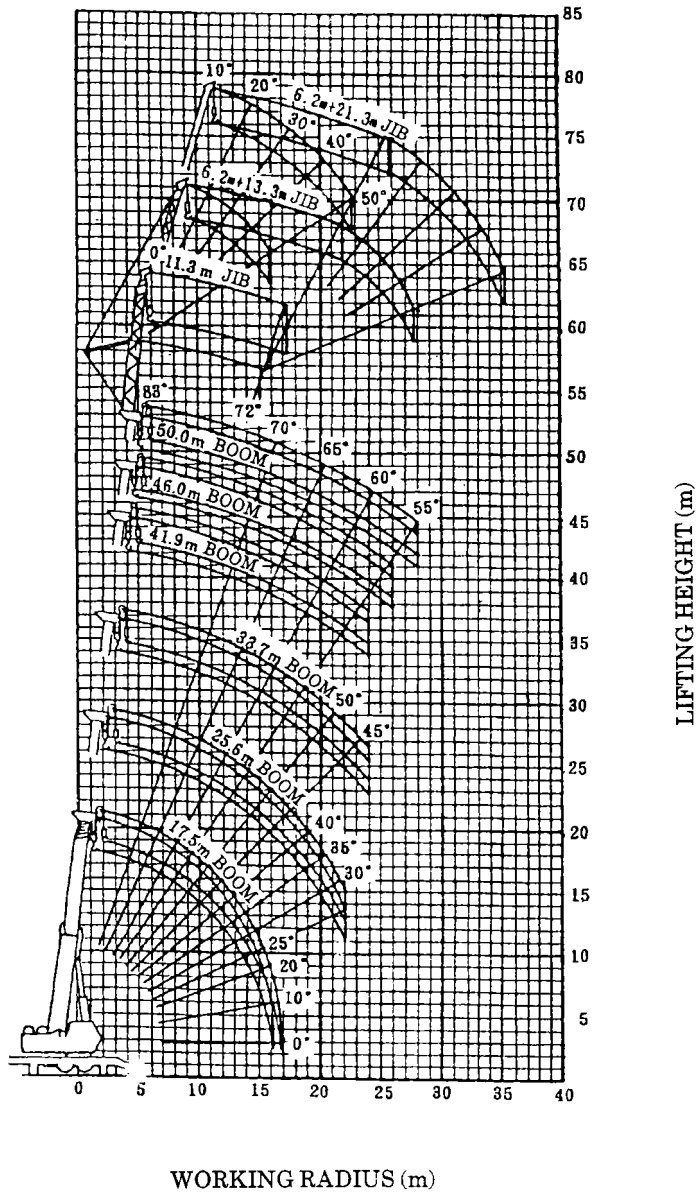

NOTES:

1. The deflection of the boom is not incorporated in the figure above.
2. The above chart is for the case where the outriggers are fully extended and where the front and rear jacks are used (over 360°).

[45m BOOM] With 35t + 4.5t counterweight
With 35t counterweight

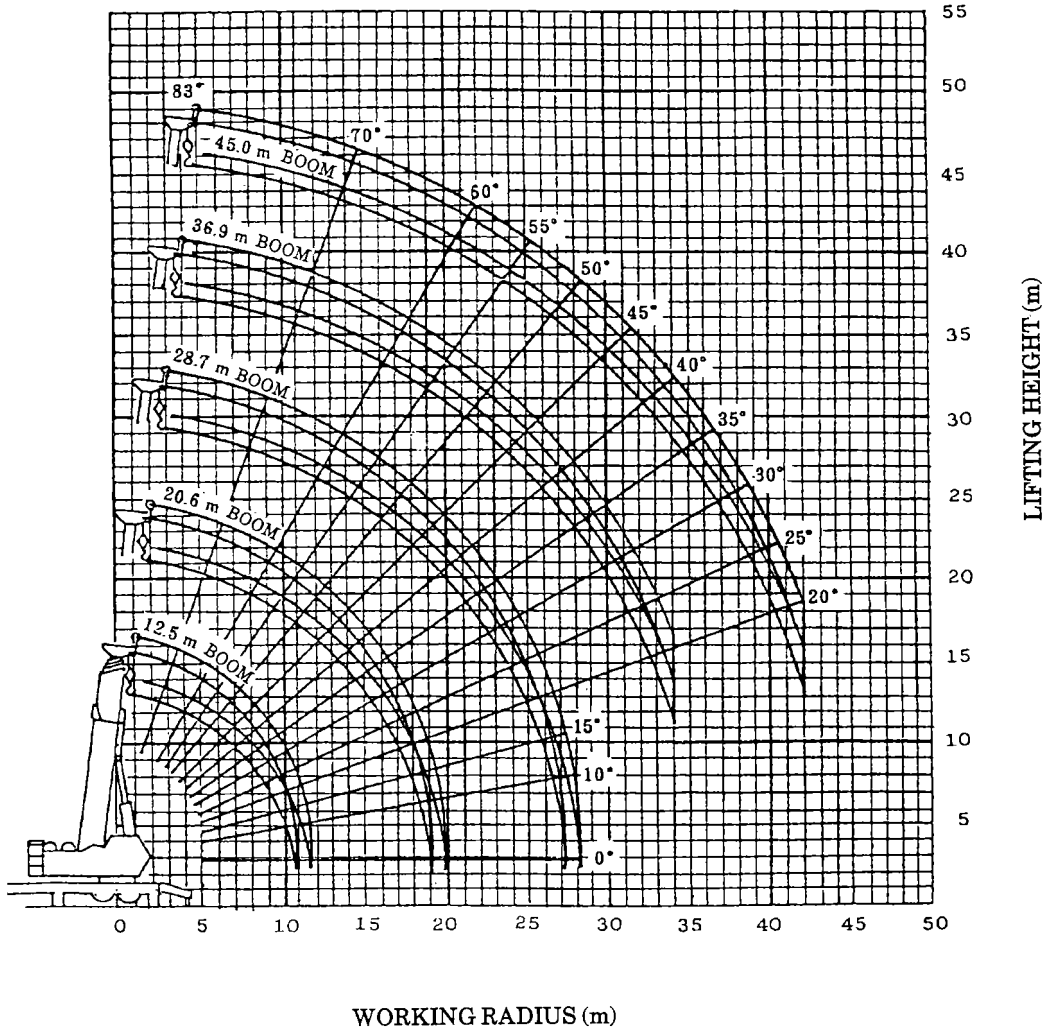

NOTES:

1. The deflection of the boom is not incorporated in the figure above.
2. The above chart is for the case where the outriggers are fully extended and where the front and rear jacks are used (over 360°).

[45m BOOM] With 18t counterweight

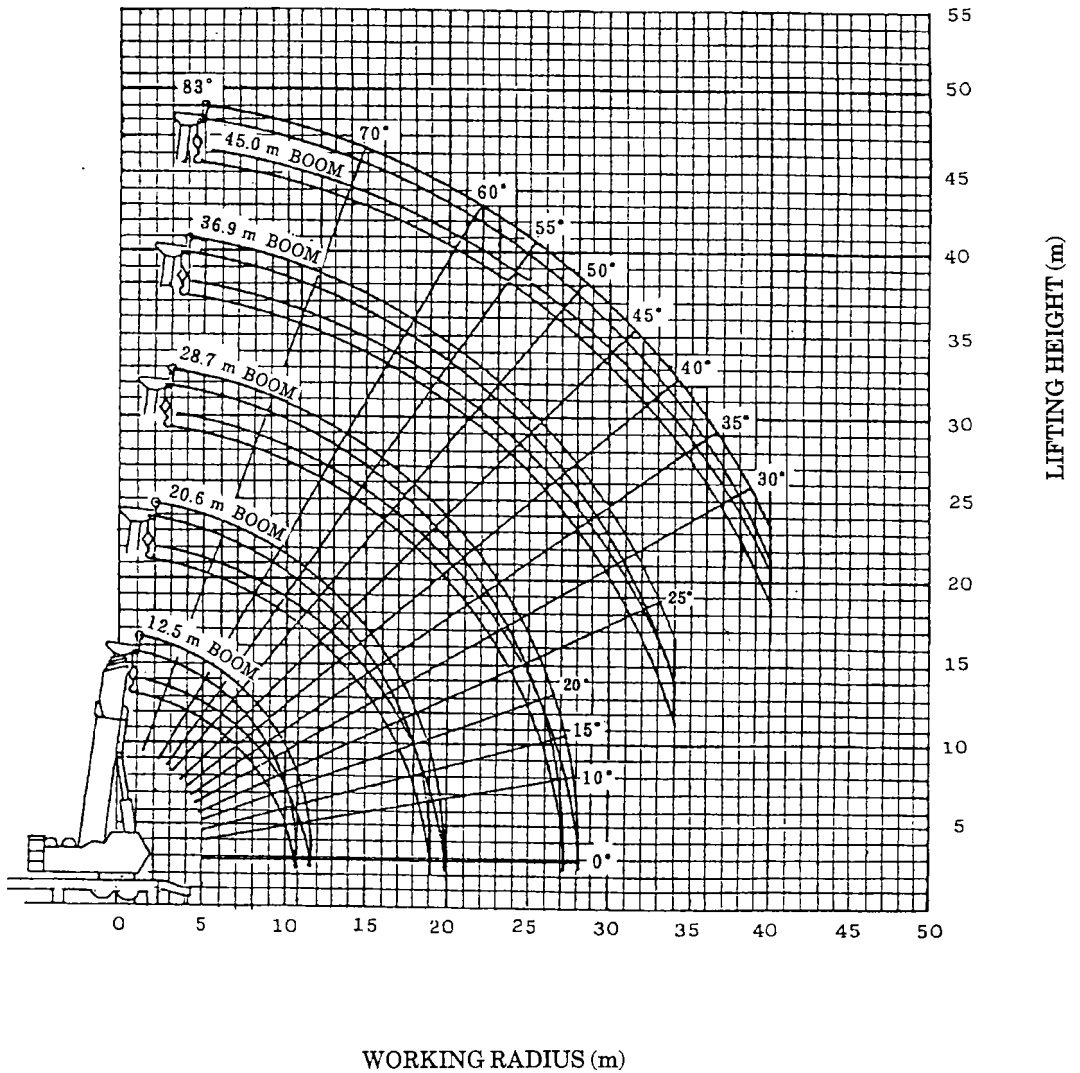

NOTES:

1. The deflection of the boom is not incorporated in the figure above.
2. The above chart is for the case where the outriggers are fully extended and where the front and rear jacks are used (over 360°).

[45m BOOM] With 4.5t counterweight

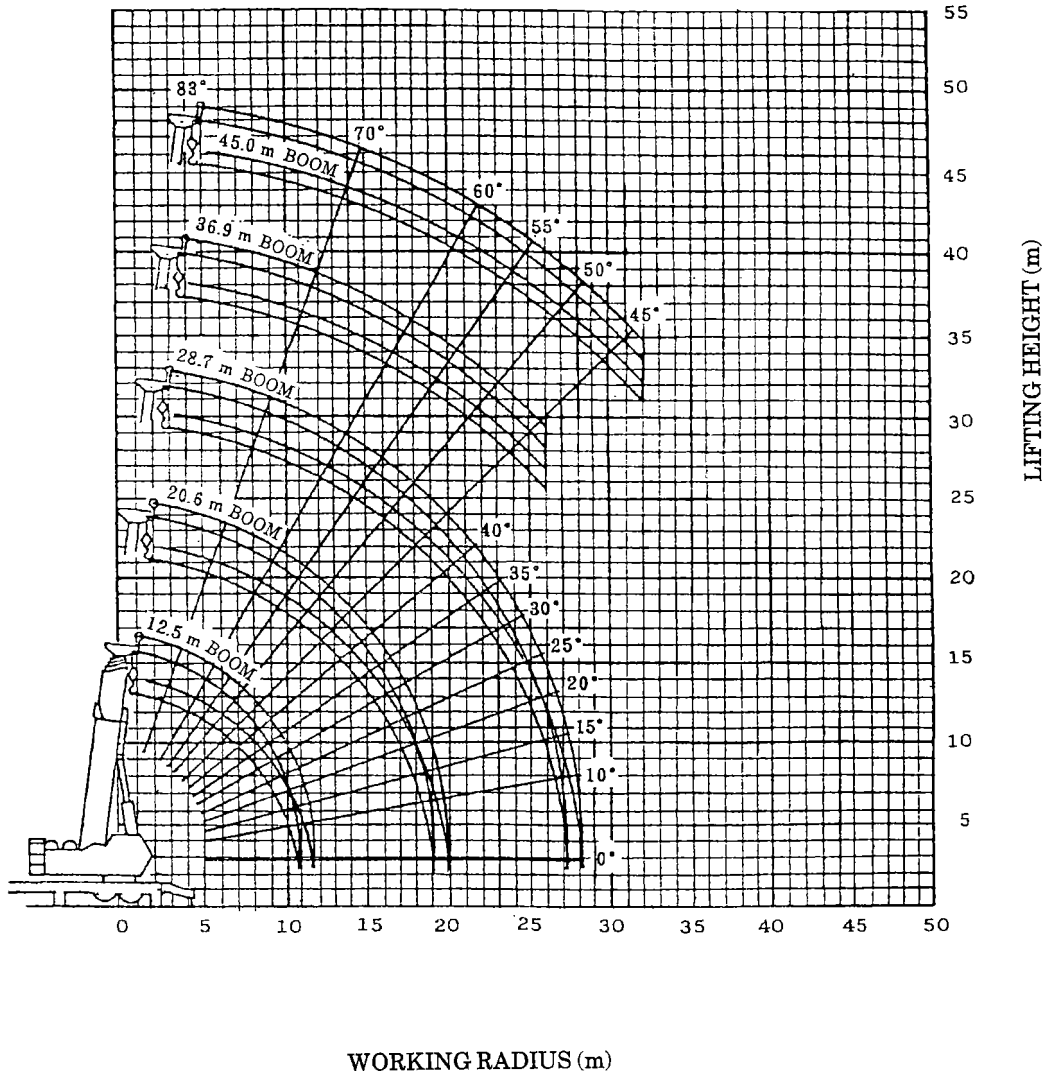

NOTES:

1. The deflection of the boom is not incorporated in the figure above.
2. The above chart is for the case where the outriggers are fully extended and where the front and rear jacks are used (over 360°).

[45m BOOM] With 0t counterweight

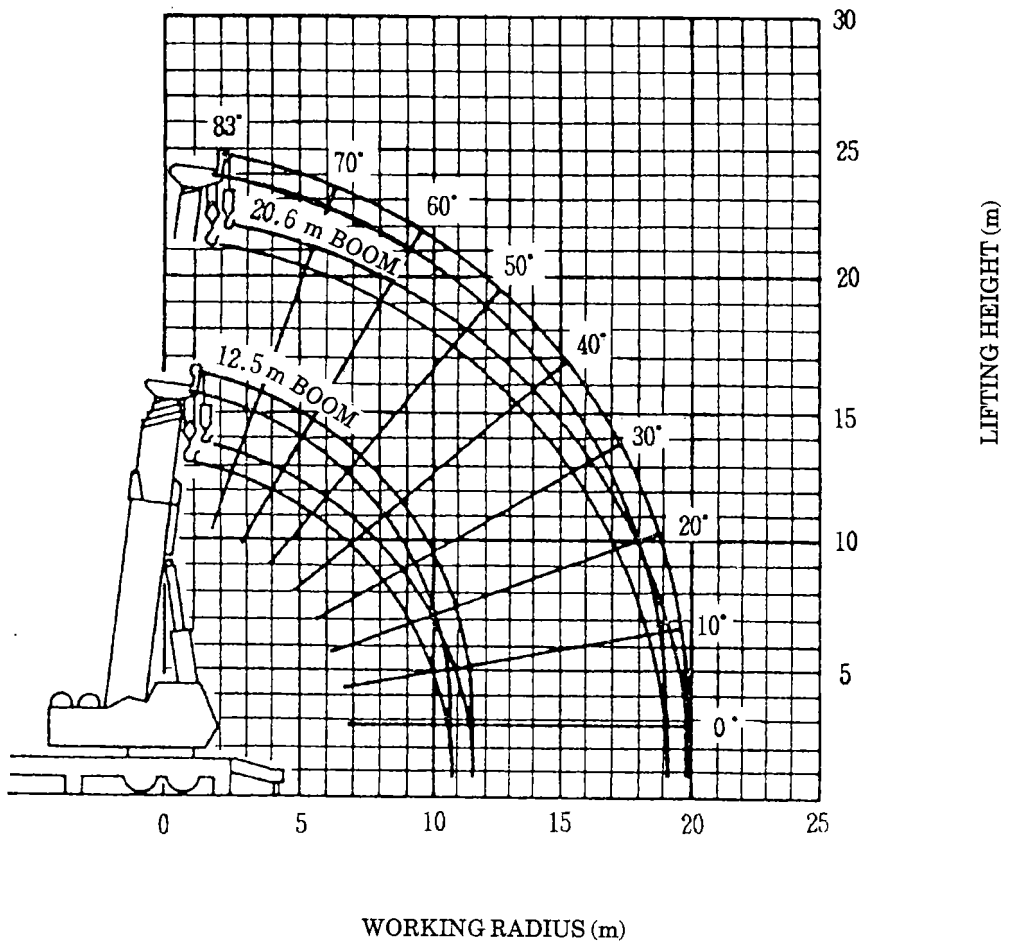

NOTES:

1. The deflection of the boom is not incorporated in the figure above.
2. The above chart is for the case where the outriggers are fully extended and where the front and rear jacks are used (over 360°).

DIMENSIONS (1/100)
[On-site traveling condition]
W-KG620WN

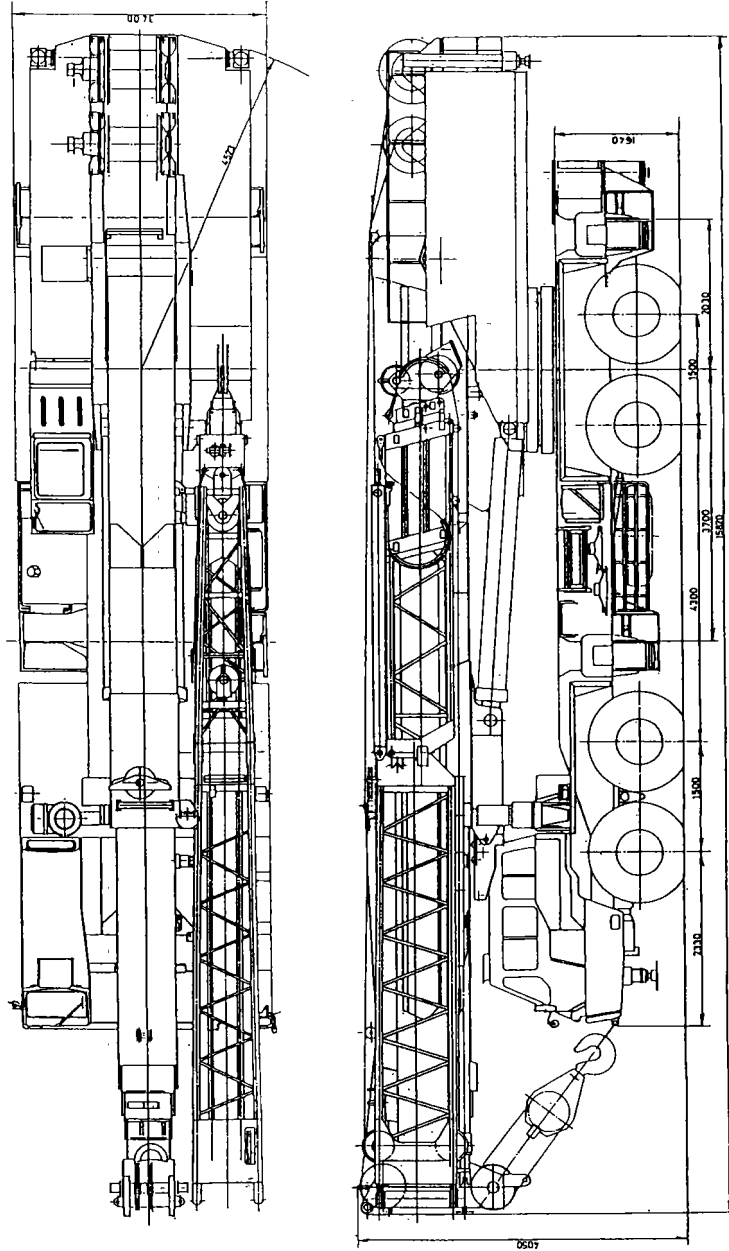

(NOTE) This drawings shows the condition with a 65t hook mounted.

DIMENSIONS (1/100)

[On-site traveling condition]

W-KA904U

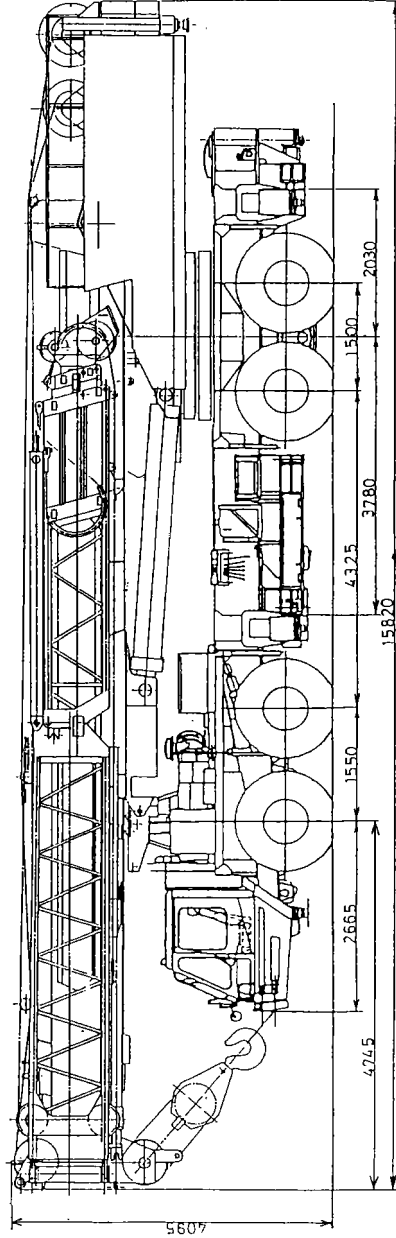
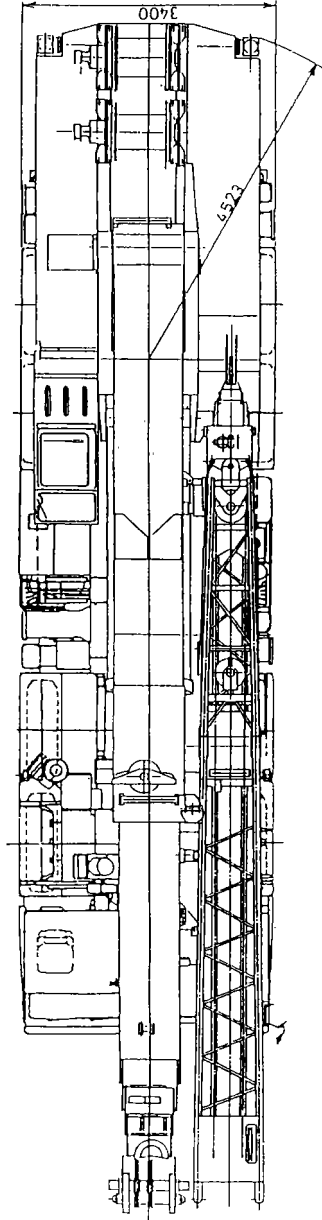

(NOTE) This drawings shows the condition with a 65t hook mounted.