



3612

*18 Ton Tele-Boom
Crawler Crane*



SPECIFICATIONS & LOAD CHARTS

Pure Excellence...

any way you like it.

For over thirty years, Mantis telescopic boom crawler cranes have set the global standard with the dependability, versatility and performance expected of a market leader. Mantis cranes are built like no other. At their hearts, are massive steel fabrications, over-sized to handle the toughest jobs, year-in and year-out. Powerful state-of-the-art hydraulics coupled with diesel engines available in a choice of sizes match perfectly to meet the most rigorous of project demands.

Mantis remains one of the few crane makers prepared and equipped to work with contractors and project engineers to develop customized lifting solutions that meet the most unusual of project challenges. Thanks to the versatile combination of heavy duty telescopic booms, hydraulically extendable crawlers, and extremely compact dimensions, Mantis cranes can often get closer to a job than bulkier, fixed length lattice boom crawler cranes or rubber-tired cranes that need outriggers to work effectively.

No other crane combines so many valuable features:

- Pick-and-carry the full crane load chart through 360°.
- Lift and walk...even with tracks retracted.
- Climb steeper grades more safely, thanks to minimized counterweight and low center of gravity.
- Pull through deep mud without bogging down.
- Telescope or lift the boom with a full load on the hook.
- Save time and money on the job due to its low clearance height, retract on-the-fly tracks and telescopic boom.
- Independent hydrostatic track drive allows pivot turns to run rings around RTs.
- Hydraulic tool circuit option powers wide choice of Mantis-approved tools.
- New luxury cab with state-of-the-art operator aids.
- Saves time and money on deployment and shipping with less haul vehicles, less time wasted on boom erection and fewer personnel on the erection crew.

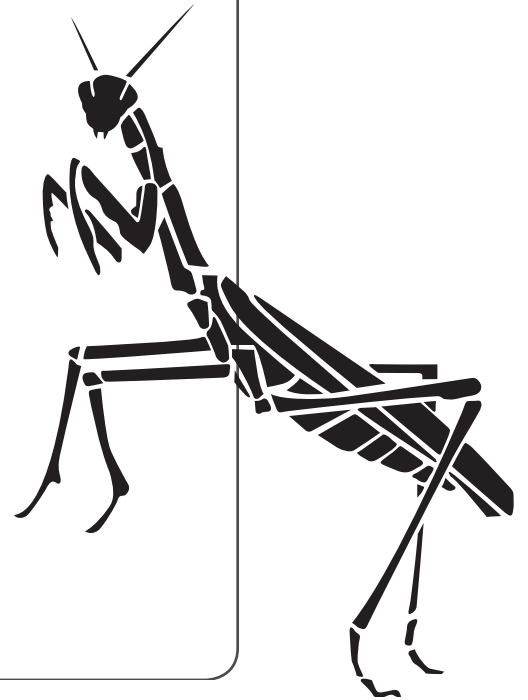

MANNTIS

3612

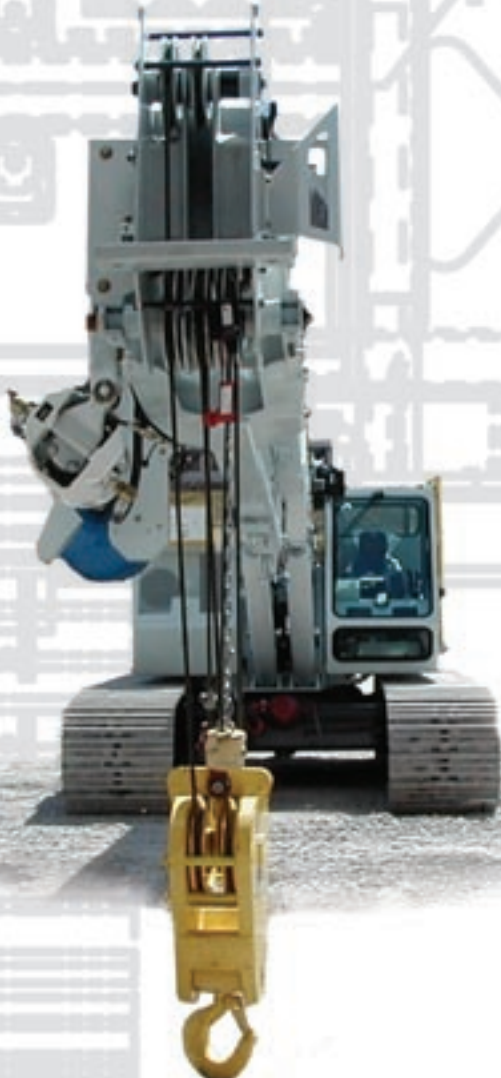
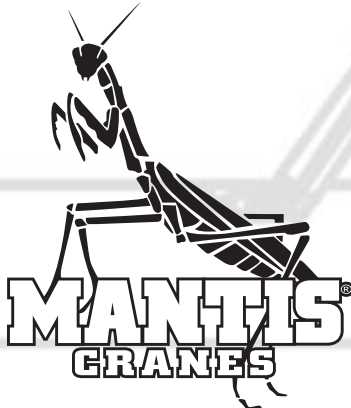

MANTIS® 3612

18 TON TELE-BOOM CRAWLER CRANE

The Mantis 3612 is the most performance proven full-size telescopic boom crawler crane in the industry. Hundreds of this bullet-proof crane have been put into service over the past 30-years and continue daily to meet the most severe of customer demands. Rated at 18-tons capacity at a wide 12ft radius (16.3-tonnes @ 3.66m), the 3612 is the smallest model in the Mantis crane range. Like all Mantis cranes, the 3612 can pick-and-carry its entire load chart through 360°. So great is the stability of this crane with its extraordinarily low center-of-gravity that it can even walk at full nominal capacity with its tracks retracted for reduced width; or with counterweight removed to further reduce ground bearing pressure or even with the boom partially telescoped.

KEY FEATURES INCLUDE:

- 18-tons (16.3-tonnes) pick-and-carry capacity – 360°.
- Telescopic jib providing for up to 100ft (30.5m) tip height.
- 173 hp (129kW) diesel engine standard.
- Low ground bearing pressure of 5.6 psi (0.39 kg/cm²)
- Mantis-engineered auger options with optional hydraulic tool circuit.
- Two-speed independent hydrostatic track drive to 3 mph (4.8 km/hr).
- 8ft (2.44m) minimum travel width (with 18ins (457mm) tracks).
- 51-54,000lb (23-24.5-tonne) shipping weight fully equipped – hauls as a single, ready-to-work load.
- Steep 70% gradeability thanks to low centre of gravity.
- 12,000lb (5.4-tonne) planetary main winch with full load single line speeds to 222 fpm (67.7 mpm).
- Optional Mantis WP-750 Heavy Duty Work Platform for 82ft (25m) working height.



POWERLINE

The 3612 established Mantis as 'the' crane for powerline work. Tough crawlers have the traction, ground clearance and massive strength to power through rough-cut forest roads. The 3612 walks with loads to 18-tons (16.3-tonnes) weight and up to 90ft (27.5m) length. The combination of lift crane/platform/auger makes the 3612 a one-crane crew.

FOUNDATION

Very few telescopic boom cranes are built to take the dynamic and vibratory loads of foundation work. Massive structural strength throughout the machine combined with brute force at the boom lift cylinder allows Mantis to use boom pressure on augers and other foundation devices. A low clearance height and ground bearing pressure lets Mantis work underground on road and rail tunnels and numerous applications where the space is tight and the jobs demanding.



ON THE JOB

PETRO CHEM

Refineries are busy, congested job sites. A Mantis crane's ability to telescope the entire load chart or lift it on the boom hoist cylinder can prove invaluable threading loads between obstructions. Being able to walk a load into place, narrow the crane with tracks retracted, change boom length in seconds and pivot on the spot puts the Mantis in a different league from cumbersome lattice crawlers and RTs with their big footprints and lifting limitations.



TANK ERECTION

Mantis cranes first found popularity in this challenging application. Low clearance height and narrow width along with low ground bearing pressure are essential in the often boggy conditions. Its pick-and-carry capability are a must to position plates.



SPECIAL APPLICATIONS

The Mantis 3612 is unbeatable as a general construction tool. Small, compact, light-of-foot and maneuverable, yet tough, fast, versatile and powerful. The 3612 can replace much larger lattice crawlers and RTs by getting close to the job and by the sheer breadth of its application potential. Seen here, a Mantis 3612 is specially equipped with a pedestal for increased clearance and "apex" track shoes for high flotation in soft terrain.



EASY HAULER

Shipping a Mantis 3612 could hardly be easier or quicker! It ships at only 8ft (2.44m) width with 18ins (457mm) track pads and up to only 10ft (3.05m) width with 30ins (762mm) pads. Fully equipped it weighs in at under 54,000lbs (24.3-tonnes) allowing it to be shipped as a single, ready-to-work load.

SPECIFICATIONS

MANTIS® 3612 18 TON TELE-BOOM CRAWLER CRANE

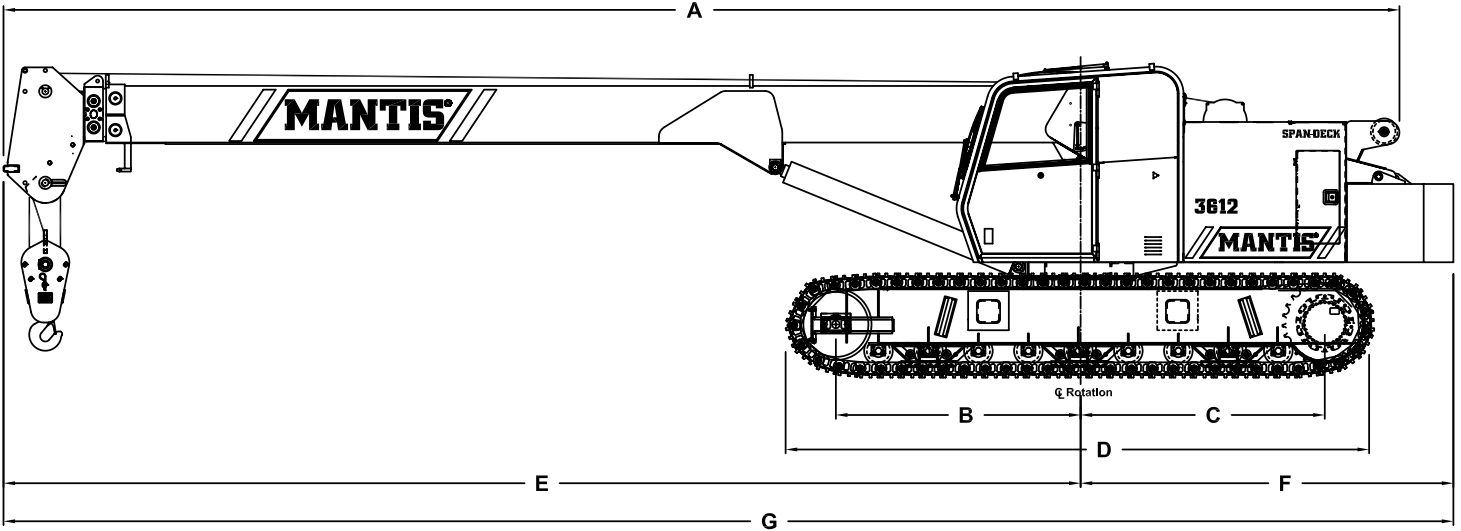

PRINCIPAL DIMENSIONS

A	Length (Counterweight Removed)	37 ft 10 in (11.53 m)
B	CL Front Track Drive to CL Rotation	79 in (2.01 m)
C	CL Rear Track Drive to CL Rotation	78 in (1.98 m)
D	Track Length	15 ft 10 in (4.83 m)
E	Boom Length to CL Rotation (Retracted)	29 ft 6 in (8.99 m)
F	Tailswing	10 ft 0 in (3.05 m)
G	Overall Length	39 ft 6 in (12.04 m)
H	Ground to Top of Engine Cover	87 in (2.21 m)
I	Track Height	34 in (864 mm)
J	Ground Clearance	13 in (330 mm)
K	Ground to Bottom of Cab	37 in (940 mm)
L	Maximum Overall Height	8 ft 6 in (2.59 m)
M	Track Width	30 in (762 mm)
N	Overall Width (Tracks Retracted)	10 ft 0 in (3.05 m)
O	Overall Working Width (Tracks Extended)	13 ft 3 in (4.04 m)

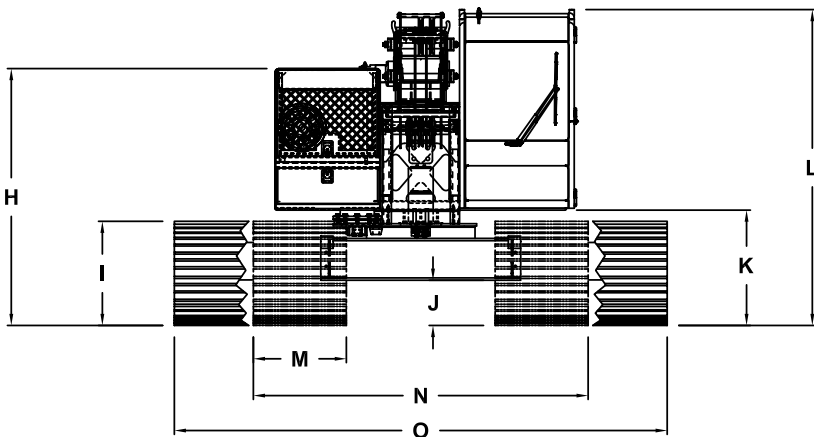

WIDTHS, WEIGHTS, AND GROUND PRESSURES*

Shoe Width	Overall Width		Area	Ground Pressure	Working Weight
	Retracted	Extended			
18 in (457 mm)	8 ft 0 in (2.44 m)	12 ft 3 in (3.73 m)	5,652 in ² (3.65 m ²)	8.9 psi (0.62 kg/cm ²)	51,287 lb (23,264 kg)
24 in (610 mm)	9 ft 0 in (2.74 m)	12 ft 9 in (3.89 m)	7,536 in ² (4.86 m ²)	6.8 psi (0.48 kg/cm ²)	52,446 lb (23,789 kg)
30 in (762 mm)	10 ft 0 in (3.05 m)	13 ft 3 in (4.04 m)	9,420 in ² (6.08 m ²)	5.6 psi (0.39 kg/cm ²)	53,602 lb (24,313 kg)

* Crane equipped with 71 ft boom, extension, jib, 18 ton hook block, and 7 ton headache ball

SPECIFICATIONS

MANTIS® 3612 18 TON TELE-BOOM CRAWLER CRANE

STANDARD CRANE AND EQUIPMENT

Boom

The main boom consists of three fully powered sections. Retracted length is 29 ft 5 in (8.97 m) and extended length is 71 ft 4 in (21.67 m). Maximum tip height is 76 ft 3 in (23.24 m).

Boom Telescoping & Elevating Systems

The elevating system features two cylinders and counterbalance lock valves which provide boom elevations from -1° to 78°. The telescoping system features a single double-acting hydraulic cylinder and counterbalance lock valves preventing the cylinder from retracting under load.

Boom Head

Four 12 in (305 mm) diameter steel sheaves on heavy-duty roller bearings are mounted in the boom head.

SUPERSTRUCTURE

Frame

The frame is an all-steel, welded structure, precision machined to accept attachment of the boom and swing components.

Operator's Cab

The fully-enclosed, air conditioned all-steel modular cab includes a lockable swinging door, acoustical lining, anti-slip floor and tinted safety glass. Sliding windows are located in the cab door and cab boom side. A vent window is positioned in the rear of the cab. Grab bars and steps are appropriately located for easy access to the cab. Erectable swing barricades are attached to the superstructure. Rear view cameras are appropriately located as are work lights.

Standard cab accessories include a two-speed windshield wiper, top glass wiper, defroster, heater, circulating fan, adjustable hand and foot throttles, six-way adjustable fabric seat with headrest, seat belt, dome light, and a dry-chemical fire extinguisher.

Instrumentation

Dash instrumentation features a tachometer, voltmeter, oil pressure gauge, temperature gauge, hour meter and fuel gauge. Indicators are provided for crane level, load moment, drum rotation, air filter restriction, hydraulic oil temperature and filter restriction, engine oil pressure and temperature.

A termination switch is located in the seat and armrest and is capable of immediately disabling all hydraulic functions as the operator rises from the seat or it can be activated by lifting the left hand armrest.

Control

Two-way hydraulic joysticks mounted in the armrests of the operator's seat control swing, boom extend, main winch and boom hoist. Three two-way hydraulic foot pedals control the travel and swing service brake functions. Travel pedal hand levers are available as an option. A fourth pedal controls engine speed.

Counterweight

The 10,000 lb (4,536 kg) single piece counterweight can be removed and installed via a pendant attached to the boom.

Load Moment Indicator & Anti-Two Block¹

Standard Rated Capacity Limiter and Anti-Two Block system includes audible and visual warnings and function shutdown. The system's LCD screen provides a continuous electronic display of working boom length, boom angle, working load radius, tip height, parts-of-line (operator set), machine track configuration (operator set), relative load moment, maximum permissible load and actual load. The standard Work Area Definition audio and video warnings aid the operator in avoiding job-site obstructions by pre-setting and defining the work area. The anti-two block weight allows quick reeving of hook blocks and sends an audible alarm of imminent two-block conditions.

Swing

The superstructure rotates 360° on an external gear shear ball slew bearing bolted to the superstructure and the carbody. The hydraulic swing drive powers the system and consists of a gear motor driving a planetary gear reducer with a shaft mounted pinion, providing infinitely variable speeds of up to 3 rpm.

Swing braking is achieved through a "failsafe", hydraulically released, spring applied, multi-disc brake which includes a foot applied service brake. Alternatively, the brake can be electrically actuated through a cab mounted switch into a "locked-on" (parking) mode. A two position house lock system is included. Regular lubrication of the bearing is achieved through a cab mounted grease applicator.

Fuel System

A 55 US gal (208 liter) tank is bolted to the superstructure. The fuel filtration system consists of an inline fuel/water separator as well as an engine mounted fuel filter.

Hydraulic System

The load sensing, open-loop hydraulic system is served by two variable volume pumps mounted in tandem. The pumps are torque limiting and pressure compensated providing a maximum output of 115 gpm (437 l/min) @ 2,200 rpm and maximum operating pressure of 4,850 psi (339.5 kg/cm²). An extra circuit is included for ready adaptation to hydraulic accessories.

The system includes two pilot operated valve banks that are pressure and flow compensated. The 150 US gal (568 liter) capacity hydraulic oil reservoir has a spin-on filler-breather cap, external sight gauge, clean-out access and a sump type drain. Hydraulic oil filtering is achieved with two 5 micron full flow cartridge type filters designed to return in-tank with bypass protection and an electronic bypass indicator.

(System pressure test ports with quick disconnect fittings are provided for diagnostic purposes.)

SPECIFICATIONS

MANTIS® 3612 18 TON TELE-BOOM CRAWLER CRANE

MAIN HOIST

Planetary geared single-speed winch includes a bent axis, variable displacement hydraulic motor and a multi-disc internal brake. Wire Rope: 400 ft (122 m) 9/16 in (14 mm) 6 x 37 EIPS, IWRC, RRL Line pulls are not based on wire rope strength, Drum rotation indicator is standard.										
Rope Layer	Maximum Line Pull		Full Load Line Speed		Pitch Diameter		Layer		Total	
1	12,000 lb	5,440 kg	182 ft/min	55.5 m/min	10.3 in	261.9 mm	66 ft	20.1 m	66 ft	20.1 m
2	10,800 lb	4,900 kg	196 ft/min	59.7 m/min	11.3 in	286.8 mm	72 ft	22.0 m	138 ft	42.1 m
3	9,850 lb	4,470 kg	205 ft/min	62.5 m/min	12.3 in	311.6 mm	79 ft	23.9 m	217 ft	66.1 m
4	9,000 lb	4,080 kg	214 ft/min	65.2 m/min	13.2 in	336.4 mm	85 ft	25.8 m	302 ft	91.9 m
5	8,350 lb	3,790 kg	222 ft/min	67.7 m/min	14.2 in	361.2 mm	91 ft	27.7 m	393 ft	119.6 m

AUXILIARY HOIST

Planetary geared single-speed winch includes a bent axis, variable displacement hydraulic motor and a multi-disc internal brake. Wire Rope: 250 ft (76 m) 9/16 in (14 mm) 6 x 37 EIPS, IWRC, RRL Line pulls are not based on wire rope strength. Drum rotation indicator is standard.										
Rope Layer	Maximum Line Pull		Full Load Line Speed		Pitch Diameter		Layer		Total	
1	12,000 lb	5,440 kg	182 ft/min	55.5 m/min	10.3 in	261.9 mm	66 ft	20.1 m	66 ft	20.1 m
2	10,800 lb	4,900 kg	196 ft/min	59.7 m/min	11.3 in	286.8 mm	72 ft	22.0 m	138 ft	42.1 m
3	9,850 lb	4,470 kg	205 ft/min	62.5 m/min	12.3 in	311.6 mm	79 ft	23.9 m	217 ft	66.1 m
4	9,000 lb	4,080 kg	214 ft/min	65.2 m/min	13.2 in	336.4 mm	85 ft	25.8 m	302 ft	91.9 m
5	8,350 lb	3,790 kg	228 ft/min	69.5 m/min	14.2 in	361.2 mm	91 ft	27.7 m	393 ft	119.6 m

STANDARD ENGINE

Cummins QSB173 (QSB5.9) (U.S. EPA Tier 3)					
Noise Emissions: Top 96.3 dBa (excludes noise from intake, exhaust, cooling system and driven components)					
Type	6 Cylinder Water Cooled	Weight (Wet)	952 lb (432 kg)	Aspiration	Turbocharged & Air Cooled
Displacement	359 cu in (5.9 l)	Oil Capacity	17.2 US quarts (16.3 l)	Air filter	Dry Type
Bore	4.02 in (102 mm)	Rated Horsepower	173 (129kW) @ 2200 rpm	Electrical system	12 volt
Stroke	4.72 in (120 mm)	Peak Torque	590 ft/lb 800 N-m @ 1500 rpm	Alternator	100 amp

MACHINE WEIGHTS

STANDARD CRANE WITH 3 SECTION 71 ft 4 in (21.73 m) FULL POWER BOOM, 1 PIECE COUNTERWEIGHT & 30 in (762 mm) TRACK SHOES	52,500 lb	23,814 kg
Crane Less Counterweight	42,500 lb	19,280 kg
Counterweight	10,000 lb	4,536 kg
OPTIONAL EQUIPMENT		
Pull & Pin Boom - 71 ft 4 in (21.73 m) 3 Section (replaces Full Power Boom) *	(1,000) lb	(453) kg
15 ft (4.57 m) A-Frame Jib	440 lb	200 kg
16 ft (4.88 m) to 25 ft (7.62 m) Telescopic Jib (includes Wire Rope)	950 lb	431 kg
Auxiliary Nose Sheave	145 lb	66 kg
Auxiliary Winch with Standard Rope	607 lb	275 kg
7 ton (6 mt) Headache Ball	162 lb	74 kg
18 ton (16 mt) Hook Block	500 lb	227 kg
Auger Ready Package	440 lb	200 kg
Complete Auger Package	1,520 lb	690 kg
60 in (1.52 m) Auger kelly bar	120 lb	54 kg
72 in (1.83 m) Auger kelly bar	140 lb	64 kg

SPECIFICATIONS

MANTIS® 3612 18 TON TELE-BOOM CRAWLER CRANE

UNDERCARRIAGE

Carbody

The steel box type carbody is fabricated with square axles to accept the crawler side frames. The top surface is precision machined to receive the swing bearing.

Side Frames

Two welded steel side frames are paired with a track group consisting of nine sealed rollers located on the bottom of the frame. Each frame includes a self-lubricating idler and spring type track tensioning device. Standard track shoes are 30 in (762 mm) wide, 3-bar semi-grousers. Optional shoes are available in 18 in (457 mm) and 24 in (609 mm) widths in both a flat pad and semi grouser configuration. The side frames extend and retract hydraulically and are controlled from the cab.

Travel

Each side frame contains a pilot controlled, two-speed track drive. The drives are hydraulic piston motors which propel the crane at a low speed of 2.0 mph (3.2 km/hr) and at a high speed of 3.0 mph (4.8 km/hr). The internal brake system is spring applied and automatically released upon actuation of the travel system.

The hydraulic travel system provides skid steering and track counter rotation and achieves an unladen gradeability of 70%.

OPTIONAL EQUIPMENT

Boom

- **Pull & Pin Boom:** three section boom - The second section is powered via a single external cylinder and the third section is manually "pulled and pinned." Retracted length is 29 ft 5 in (8.97 m) and extended length is 71 ft (21.64 m). Maximum tip height is 76 ft 2 in (23.22 m).

Boom Attachments

- **A-Frame Jib:** 15 ft (4.57 m) pendant suspended, underslung and offsetable at 10°, 20° & 30°. Maximum tip height is 90 ft (27.43 m).
- **Telescopic Jib:** 16 ft (4.88 m) to 25 ft (7.62 m) pulled and pinned, pendant suspended, underslung and offsetable at 10°, 20° & 30°. Maximum tip height is 100 ft (30.48 m).
- **Auxiliary Nose Sheave:** quick reeve, single 12 in (305 mm) diameter high-strength, steel sheave mounted on a heavy-duty roller bearing.
- **Wire Rope:** rotation resistant, (non-spin) Dyform-18 HSLR.
- **Headache Ball:** 7 ton (6 mt) ball includes a swivel hook with a safety latch.
- **Hook Block:** 18 ton (16 mt) hook block contains two 12 in (305 mm) diameter steel sheaves mounted on heavy-duty roller bearings with a swivel hook and safety latch.

Hydraulic

- **Auger Ready Package:** includes hoses, fasteners and stowage bracket assembly mounted to the base section of the boom with a flow capability of 34 gpm (130 l/min).
- **Complete Auger Package:** adds a two speed auger motor/gear box and one 60 in (1.52 m) Kelly bar to the Auger Ready Package.
- **Tool Circuit:** provides 6 gpm (23 l/min) and 12 gpm (45 l/min) at 2,500 psi (176 kg/cm²) through a 50 ft (15.24 m) twin hose reel with quick disconnect fittings to operate open center tools.

Other Options

- **Free Fall Hoists:** winches are available in controlled free fall configurations.
- **Crane Cab Access Walkway:** a pair of 54.5 in (1.38 m) wide x 25 in (635 mm) deep walkways which attach to both the front and rear of the carbody and allow for easier egress and ingress to the operator's cab when the crane's upper rotating frame is not aligned front to rear.
- **Model WP750 Work Platform:** 36 in x 72 in (914 mm x 1 828 mm), all-steel, two-person platform with a maximum capacity of 750 lb (340 kg). A test weight and boom head adapter are included in the package. Operation and control are by the crane operator from the cab. Radio (RF) controls to enable remote operation from the platform are available.

(See separate WP750 Specification for a complete description of standard and optional Work Platform equipment.)

¹Load moment indicating and anti-two block systems are operator aids and must never be used in lieu of job site lift planning calculations by the operator which must take into account ground conditions, weather and all other environmental factors prevailing at the time of the lift. Prices and specifications are subject to change at any time without prior notice and are for factory installation at time of original manufacture. F.O.B Plant; Richlands, VA 24641. Illustrations and photographs may show optional equipment. Supersedes all previous issues. Please see www.mantiscranes.com for most current information.

LOAD CHARTS

MANTIS® 3612 18 TON TELE-BOOM CRAWLER CRANE

70 FT MAIN BOOM, 16 FT TO 25 FT EXTENDABLE JIB

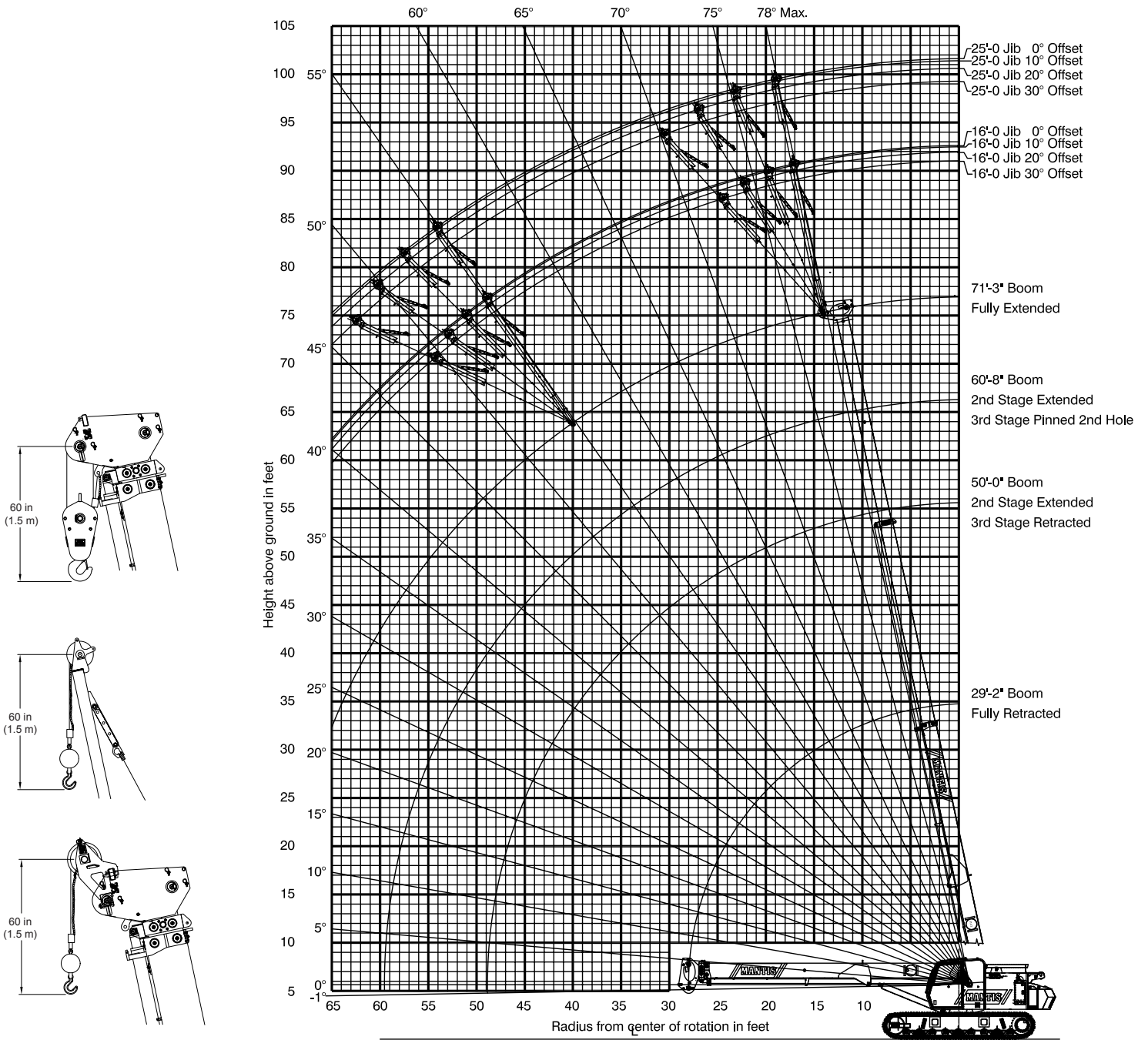

CAUTION

THESE CHART VALUES ARE ONLY A GUIDE AND MUST NOT BE USED TO OPERATE THE CRANE. USE ONLY THE IN CAB LOAD CHARTS AND OPERATOR'S MANUAL FURNISHED WITH THE CRANE.

MANTIS® 3612 18 TON TELE-BOOM CRAWLER CRANE

70 FT MAIN BOOM, 15 FT JIB

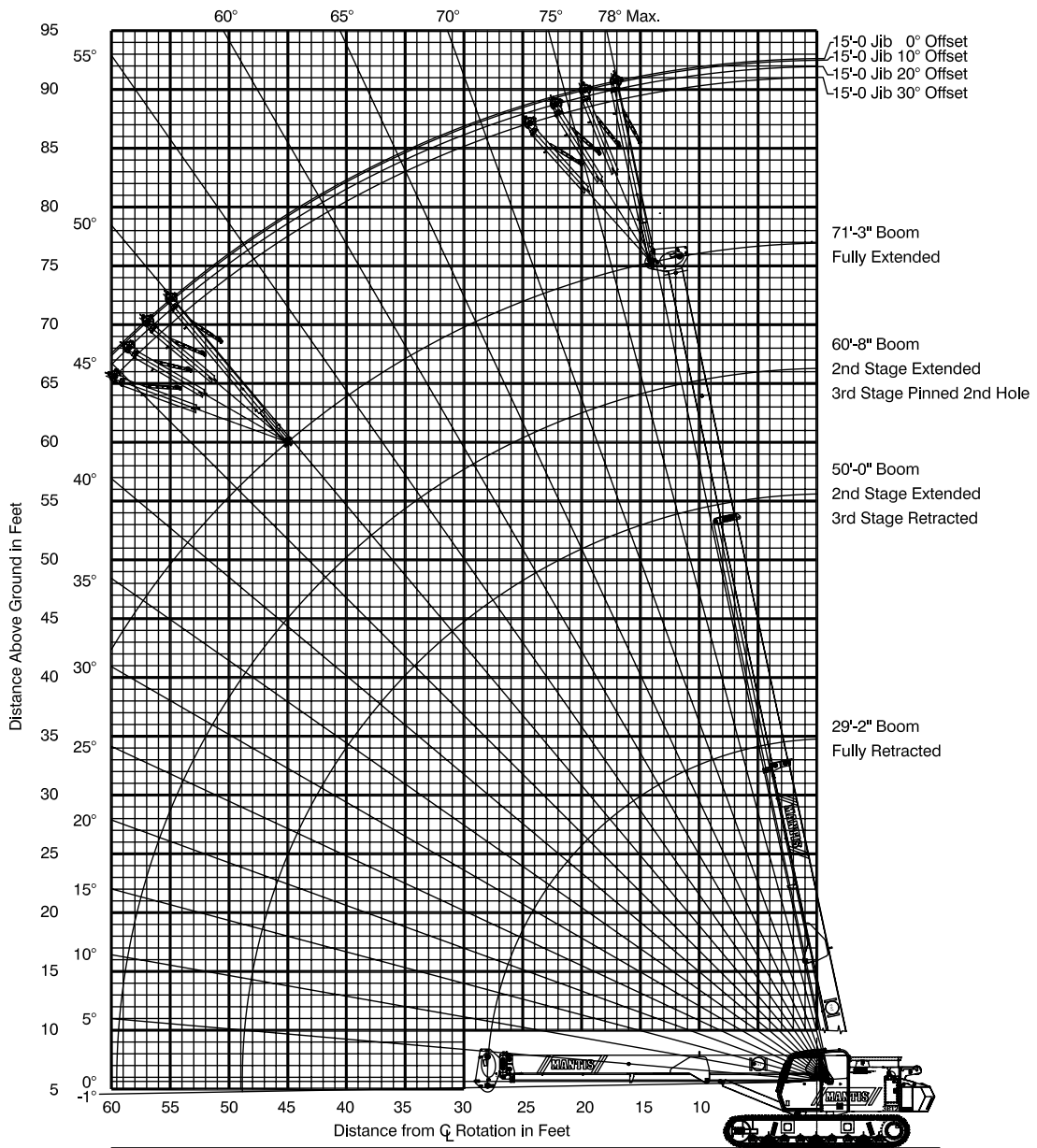

THESE CHART VALUES ARE ONLY A GUIDE AND MUST NOT BE USED TO OPERATE THE CRANE. USE ONLY THE IN CAB LOAD CHARTS AND OPERATOR'S MANUAL FURNISHED WITH THE CRANE.

LOAD CHARTS

MANTIS® 3612 18 TON TELE-BOOM CRAWLER CRANE

LIFTING CAPACITIES

IN THOUSANDS OF POUNDS; 360°, 75% OF TIPPING, FIRM & LEVEL GROUND

MAIN BOOM with TRACKS FULLY EXTENDED											
10,000 lb COUNTERWEIGHT					ZERO COUNTERWEIGHT						
	MAIN BOOM LENGTH (ft)					MAIN BOOM LENGTH (ft)					
	29.2	39.6	50.0	60.6	71.3	29.2	39.6	50.0	60.6	71.3	
10	36.0 68.3°	36.0* 74.2°				36.0 68.3°	36.0* 74.2°				10
12	36.0 64.0°	36.0 71.2°	36.0 75.2°	36.0* 77.9°		29.0 64.0°	29.0 71.2°	29.0 75.2°	29.0* 77.9°		12
15	24.8 57.2°	24.8 66.5°	24.8 71.6°	24.8 74.9°	24.8* 77.2°	19.2 57.2°	19.2 66.5°	19.2 71.6°	19.2 74.9°	19.2* 77.2°	15
20	16.4 44.3°	16.4 58.3°	16.4 65.4°	16.4 70.0°	16.4 73.1°	12.2 44.3°	12.2 58.3°	12.2 65.4°	12.2 70.0°	12.2 73.1°	20
25	11.5 27.1°	11.5 49.2°	11.5 58.9°	11.5 64.8°	11.5 68.8°	8.1 27.1°	8.1 49.2°	8.1 58.9°	8.1 64.8°	8.1 68.8°	25
30		8.4 38.7°	8.4 51.9°	8.4 59.5°	8.4 64.4°		5.6 38.7°	5.6 51.9°	5.6 59.5°	5.6 64.4°	30
35		6.5 24.7°	6.5 44.2°	6.5 53.8°	6.5 59.9°		4.1 24.7°	4.1 44.2°	4.1 53.8°	4.1 59.9°	35
40			5.1 35.1°	5.1 47.7°	5.1 55.1°			3.0 35.1°	3.0 47.7°	3.0 55.1°	40
45			4.0 23.1°	4.0 40.8°	4.0 50.0°			NR	NR	NR	45
50				3.3 32.9°	3.3 44.5°				NR	NR	50
55				2.7 22.6°	2.7 38.4°				NR	NR	55
60					2.3 31.3°					NR	60

MAIN BOOM with TRACKS FULLY RETRACTED						
10,000 lb COUNTERWEIGHT						
RADIUS (ft)	MAIN BOOM LENGTH (ft)					RADIUS (ft)
	29.2	39.6	50.0	60.6	71.3	
10	36.0 68.3°	36.0 74.2°				10
12	36.0 64.0°	36.0 71.2°	36.0 75.2°	36.0 77.9°		12
14	19.5 59.5°	19.5 68.1°	19.5 72.8°	19.5 75.9°		14
16	13.8 54.8°	13.8 64.9°	13.8 70.4°	13.8 74.0°	13.8 76.4°	16
18	11.4 22.3°	11.4 47.3°	11.4 57.6°	11.4 63.8°	11.4 67.9°	18
20	9.6 44.3°	9.6 58.3°	9.6 65.4°	9.6 70.0°	9.6 73.1°	20
22	8.3 38.3°	8.3 54.8°	8.3 62.9°	8.3 67.9°	8.3 71.4°	22
24	7.1 31.3°	7.1 51.1°	7.1 60.3°	7.1 65.9°	7.1 69.7°	24
26	6.2 22.3°	6.2 47.3°	6.2 57.6°	6.2 63.8°	6.2 67.9°	26
28	5.4 3.9°	5.4 43.2°	5.4 54.8°	5.4 61.7°	5.4 66.2°	28
30		4.8 38.7°	4.8 51.9°	4.8 59.5°	4.8 64.4°	30
32		4.1 33.7°	4.1 48.9°	4.1 57.2°	4.1 62.6°	32
34		3.6 28.0°	3.6 45.8°	3.6 55.0°	3.6 60.8°	34
36		3.1 20.8°	3.1 42.5°	3.1 52.6°	3.1 58.9°	36
38		2.7 9.3°	2.7 38.9°	2.7 50.2°	2.7 57.0°	38
40			2.4 35.1°	2.4 47.7°	2.4 55.1°	40
42			2.0 30.8°	2.0 45.0°	2.0 53.1°	42

* Capacity based on maximum obtainable boom angle.

° Boom angles are stated in degrees.

Weight Reductions Load Handling Devices	
Hookblock: 18 Ton - 2 Sheave	500 lbs
Overhaul Ball: 7 Ton w/Swivel	162 lbs
Optional Load Handling Devices	
15 ft. A-Frame Jib - Stowed**	170 lbs
15 ft. A-Frame Jib - Erected**	550 lbs
16 ft.- 25ft. Extensible Jib - Stowed**	350 lbs
16 ft.- 25ft. Extensible Jib - Erected**	1,250 lbs
Auxillary Nose Sheave**	145 lbs
Auger Ready Package**	250 lbs
Auger Package Complete - Stowed**	800 lbs
Auger Package Complete - Erected**	1,500 lbs

** Reduction of main boom capacities.

ZERO DEGREE BOOM ANGLE			
MAXIMUM CAPACITY			
with TRACKS FULLY EXTENDED			
10,000 lb COUNTERWEIGHT			
BOOM LENGTH (ft)	RADIUS (ft)	LOAD (lb) (x 1000)	BOOM LENGTH (ft)
29.2	28.1	9.3	29.2
39.6	38.5	5.5	39.6
50.0	48.9	3.4	50.0
60.6	59.5	2.3	60.6



THESE CHART VALUES ARE ONLY A GUIDE AND MUST NOT BE USED TO OPERATE THE CRANE. USE ONLY THE IN CAB LOAD CHARTS AND OPERATOR'S MANUAL FURNISHED WITH THE CRANE.

LOAD CHARTS

MANTIS® 3612 18 TON TELE-BOOM CRAWLER CRANE

LIFTING CAPACITIES

IN THOUSANDS OF POUNDS; 360°, 75% OF TIPPING, FIRM & LEVEL GROUND

AUXILIARY NOSE SHEAVE with TRACKS FULLY EXTENDED						
10,000 lb COUNTERWEIGHT						
RADIUS (ft)	MAIN BOOM LENGTH (ft)					RADIUS (ft)
	29.2	39.6	50.0	60.6	71.3	
10	9.0	9.0				10
	68.3°	74.2°				
12	9.0	9.0	9.0	9.0		12
	64.0°	71.2°	75.2°	77.9°		
15	9.0	9.0	9.0	9.0	9.0	15
	57.2°	66.5°	71.6°	74.9°	77.2°	
20	9.0	9.0	9.0	9.0	9.0	20
	44.3°	58.3°	65.4°	70.0°	73.1°	
25	9.0	9.0	9.0	9.0	9.0	25
	27.1°	49.2°	58.9°	64.8°	68.8°	
30		8.4	8.4	8.4	8.4	30
		38.7°	51.9°	59.5°	64.4°	
35		6.5	6.5	6.5	6.5	35
		24.7°	44.2°	53.8°	59.9°	
40			5.1	5.1	5.1	40
			35.1°	47.7°	55.1°	
45			4.0	4.0	4.0	45
			23.1°	40.8°	50.0°	
50				3.3	3.3	50
				32.9°	44.5°	
55				2.7	2.7	55
				22.6°	38.4°	
60					2.3	60
					31.3°	

15' A-FRAME JIB TRACKS FULLY EXTENDED					
10,000 lb COUNTERWEIGHT					
Boom Angle	15' Jib Offset Angles				Boom Angle
	0°	10°	20°	30°	
75°	5.0	2.5	2.5	2.5	75°
70°	4.6	2.3	2.3	2.3	70°
65°	4.1	2.1	2.1	2.1	65°
60°	3.7	1.8	1.8	1.8	60°
55°	3.2	1.6	1.6	1.6	55°
50°	2.8	1.4	1.4	1.4	50°
45°	2.3	1.2	1.2	1.2	45°
40°	1.9	1.0	1.0	1.0	40°

° Boom angles are stated in degrees.

16' to 25' EXTENDABLE JIB TRACKS FULLY EXTENDED									
10,000 lb COUNTERWEIGHT									
Boom Angle	16' Jib Offset Angles				25' Jib Offset Angles				Boom Angle
	0°	10°	20°	30°	0°	10°	20°	30°	
75°	6.6	2.2	2.2	2.2	4.1	1.3	1.3	1.3	75°
70°	4.9	2.0	2.0	2.0	3.1	1.2	1.2	1.2	70°
65°	3.9	1.8	1.8	1.8	2.4	1.1	1.1	1.1	65°
60°	3.3	1.7	1.7	1.7	2.0	1.0	1.0	1.0	60°
55°	2.8	1.6	1.6	1.6	1.7	1.0	1.0	1.0	55°
50°	2.5	1.5	1.5	1.5	1.5	0.9	0.9	0.9	50°
45°	2.2	1.5	1.5	1.5	1.3	0.9	0.9	0.9	45°



CAUTION

THESE CHART VALUES ARE ONLY A GUIDE AND MUST NOT BE USED TO OPERATE THE CRANE. USE ONLY THE IN CAB LOAD CHARTS AND OPERATOR'S MANUAL FURNISHED WITH THE CRANE.

LOAD CHARTS

MANTIS® 3612 18 TON TELE-BOOM CRAWLER CRANE

MANTIS WP-750 WORK PLATFORM

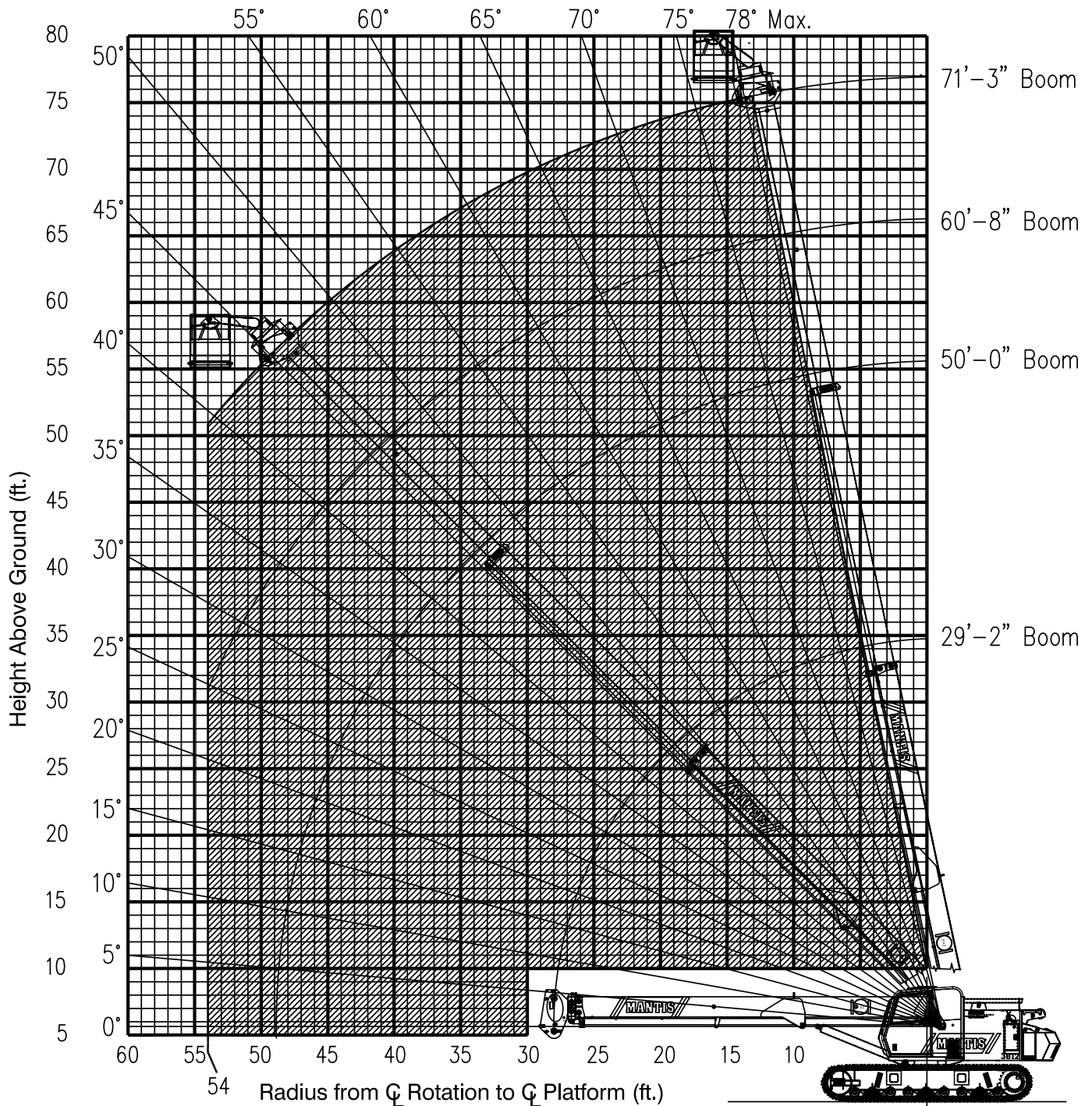

Limits of operation: Maximum load capacity = 750 lb Maximum radius when mounted on main boom = 54 ft



THESE CHART VALUES ARE ONLY A GUIDE AND MUST NOT BE USED TO OPERATE THE CRANE. USE ONLY THE IN CAB LOAD CHARTS AND OPERATOR'S MANUAL FURNISHED WITH THE CRANE.

LOAD CHARTS

MANTIS® 3612 18 TON TELE-BOOM CRAWLER CRANE

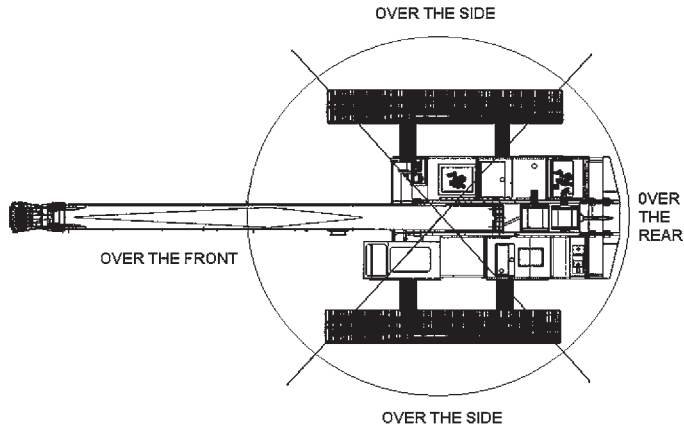

MANTIS MODEL 3612				
WIRE ROPE LINE PULL CAPACITIES				
PARTS OF LINE	MAIN WINCH (pounds)	AUX WINCH (pounds)	PARTS OF LINE	MAIN WINCH (pounds)
1	9,600	9,600	4	38,400
2	19,200	N/A	5	48,000
3	28,800	N/A		
9/16 inch diameter wire rope, 6 x 37 Class, EIP, IWRC				

PLEASE READ, UNDERSTAND, AND FOLLOW THE MANUALS FURNISHED WITH THE CRANE (OPERATOR'S AND SAFETY) AS WELL AS THE CAPACITY LIMITATIONS AND GENERAL CONDITIONS LISTED BELOW PRIOR TO OPERATION OF THE CRANE. FAILURE TO DO SO MAY RESULT IN AN ACCIDENT.

Capacity Limitations and General Conditions:

1. This MANTIS CRANE as manufactured, meets the requirements of ANSI B30.5 (2000). Structure and stability have been tested in accordance with SAE J1063 and SAE J765, respectively. Modifications to the crane or use of optional equipment other than specified by the manufacturer can result in a reduction of capacity.
2. The main boom and auxiliary boom head lifting capacities are determined by boom length and load radius. The extension and jib lifting capacities are determined by boom angle.
3. Rated capacity loads given are maximum covered by the manufacturer's warranty and are based on a freely suspended load with NO allowance for factors such as out-of-level operation, supporting surface conditions, hazardous surroundings, experience of personnel, etc. The operator shall establish practical working loads based on prevailing operating conditions, such as, but not limited to the above.
4. All rated capacity loads shown apply to original equipment as supplied by SpanDeck, Inc.
5. All rated capacity loads appearing above the bold line are based on structural strength; tipping should not be relied upon as a capacity limitation.
6. All rated capacity loads appearing below the bold line are based on stability and do not exceed 75% of tipping.
7. Deductions from rated capacities must be made for the weight of the hook block, headache ball, slings, spreader bar, and any other suspended equipment. See Lifting Capacity Deduction Chart for load handling devices supplied by SpanDeck, Inc.
8. A properly calibrated and maintained Load Moment Indicator (LMI) system will indicate boom mounted and other suspended equipment.
9. When making lifts where capacities may be within a zone limited by structural strength, the operator shall determine that the weight of the load is known within plus or minus (+/-) ten percent (10%) before making lift.
10. It is permissible to attempt to telescope boom with a load within the limits of rated capacities. However, boom telescope system hydraulic pressure, and/or boom lubrication may affect operation.
11. Side pull on boom is extremely dangerous and must be avoided.
12. **DO NOT** exceed manufacturers maximum specified reeving.
13. **DO NOT** lift load or extend boom without proper configuration of crane per load chart selected.
14. **DO NOT** attempt to lift any load when wind speed exceeds 20 mph.

Load moment indicating and anti-two block systems are operator aids and must never be used in lieu of job site lift planning calculations by the operator which must take into account ground conditions, weather and all other environmental factors prevailing at the time of the lift. Prices and specifications are subject to change at any time without prior notice and are for factory installation at the time of original manufacture. F.O.B Plant; Richlands, VA 24641. Illustrations and photographs may show optional equipment. Supercedes all previous issues. Please see www.mantiscranes.com for most current information.



THESE CHART VALUES ARE ONLY A GUIDE AND MUST NOT BE USED TO OPERATE THE CRANE. USE ONLY THE IN CAB LOAD CHARTS AND OPERATOR'S MANUAL FURNISHED WITH THE CRANE.

MANTIS[®] PRODUCT LINE

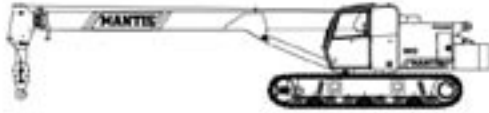

3612 - 18 US TON CRAWLER

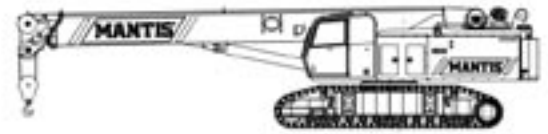

9010 - 45 US TON CRAWLER

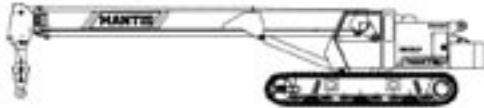

3612LP - 18 US TON CRAWLER

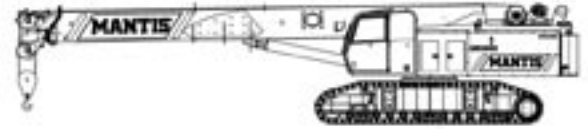

10010Mx - 50 US TON CRAWLER



6010 - 30 US TON CRAWLER

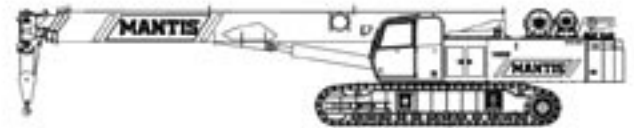

14010 - 70 US TON CRAWLER



6010LP - 30 US TON CRAWLER

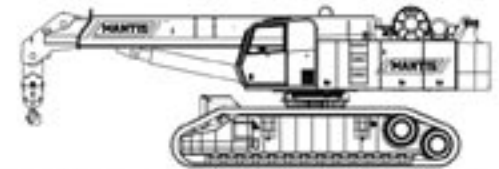

200RS - 100 US TON CRAWLER

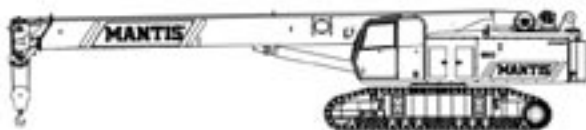

8012 - 40 US TON CRAWLER

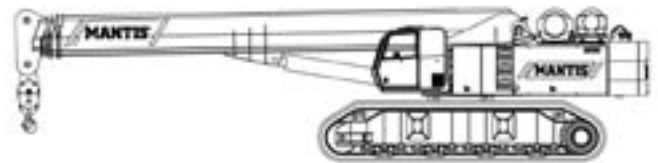

20010 - 100 US TON CRAWLER

MANTIS CRANES

Mfg. by SpanDeck, Inc.

129 CONFEDERATE DRIVE • FRANKLIN, TN 37064 USA

PHONE: 800-272-3325 • FAX: 615-790-6803

sales@mantiscranes.com • www.mantiscranes.com

