

7300

MasterTech

Max. Lifting Capacity (Heavy-duty Lift) : 300 tons at 5.0 m
Max. Boom Length (Light-duty Lift) : 96 m
Max. Lifting Capacity (Luffing Tower) : 87.5 tons at 16.0 m
Max. Tower + Jib Length : 60 m + 60 m

Specifications

Increased Lifting Capacity

The new luffing tower design dramatically increases lifting capacity.

Closer to the Object with Further Reach

The boom and jib angles have also been increased with a maximum operating radius of 74 m, also ensuring efficient operation close to existing structures.

Versatility of the Boom and Jib

A nesting boom and minimal attachment changeover requirements accommodate many operating configurations ranging from heavy-duty to luffing tower applications.

Superior Hydraulic Technology

Superior hydraulic technology improves operating efficiency and safety. The high-speed winch provides fast 100m/min hoisting and lowering, and a shockless control system enhances safety in hoisting and lowering the hook and boom.

Easy Transportation

The main body breaks down into five components, each weighs less than 35 tons.

General Dimensions

Unit: mm

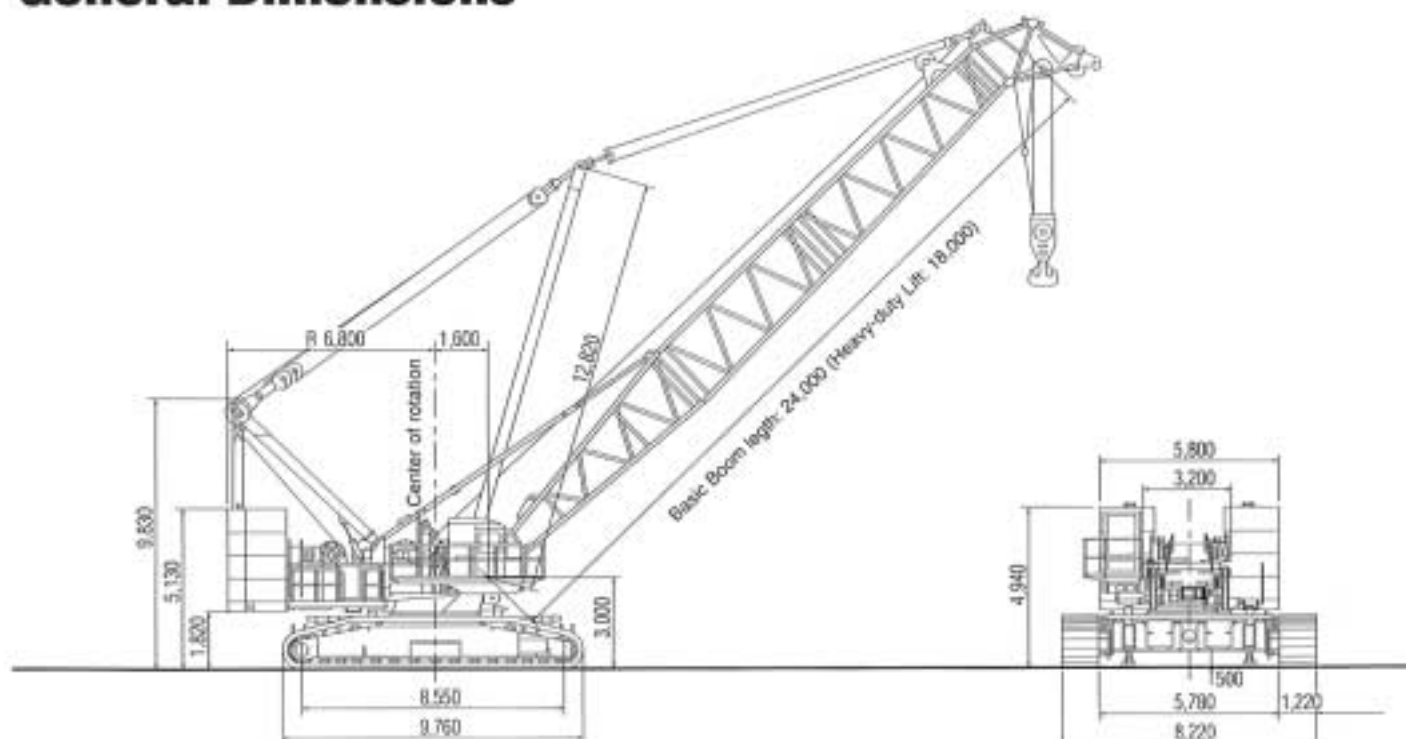

Configuration and Style of Attachment

Style and Combination of Boom and Jib

Style	Heavy-duty Lift	Basic Crane	Light-duty Lift	Luffing Tower
Specifications				
Max. lifting capacity	300 t x 5.0 m	180 t x 8.0 m	100 t x 12.0 m	87.5 t x 16.0 m
Basic boom length	18 m	24 m	30 m	30 m + 24 m
Max. boom length	42 m	72 m	96 m	60 m + 60 m
Crane Boom/Tower Boom				
Lower boom-Mast	Common use (1)	Common use (1)	Common use (1)	Common use (1)
Heavy-duty tip	Heavy-duty only	N.A.	N.A.	N.A.
Tower tip	N.A.	Common use (1)	N.A.	Common use (1)
6 m insert boom: A	Common use (1)	Common use (1)	Common use (1)	Common use (1)
12 m insert boom: C	Common use (2)	Common use (4)	Common use (4)	Common use (3)
6 m tapered boom: D	N.A.	N.A.	Light-duty only	N.A.
7.8 m tapered boom: B	Common use (1)	Common use (1)	N.A.	Common use (1)
Luffing Jib				
Lower jib	N.A.	N.A.	N.A.	Luffing tower only
Light-duty tip	N.A.	N.A.	Common use (1)	Common use (1)
6m insert jib: E	N.A.	N.A.	Common use (1)	Common use (1)
12 m insert jib: F	N.A.	N.A.	Common use (1)	Common use (3)

Note:

- Figures in () means the numbers of the maximum usable boom (or jib) respectively.
- N.A.: Not applicable

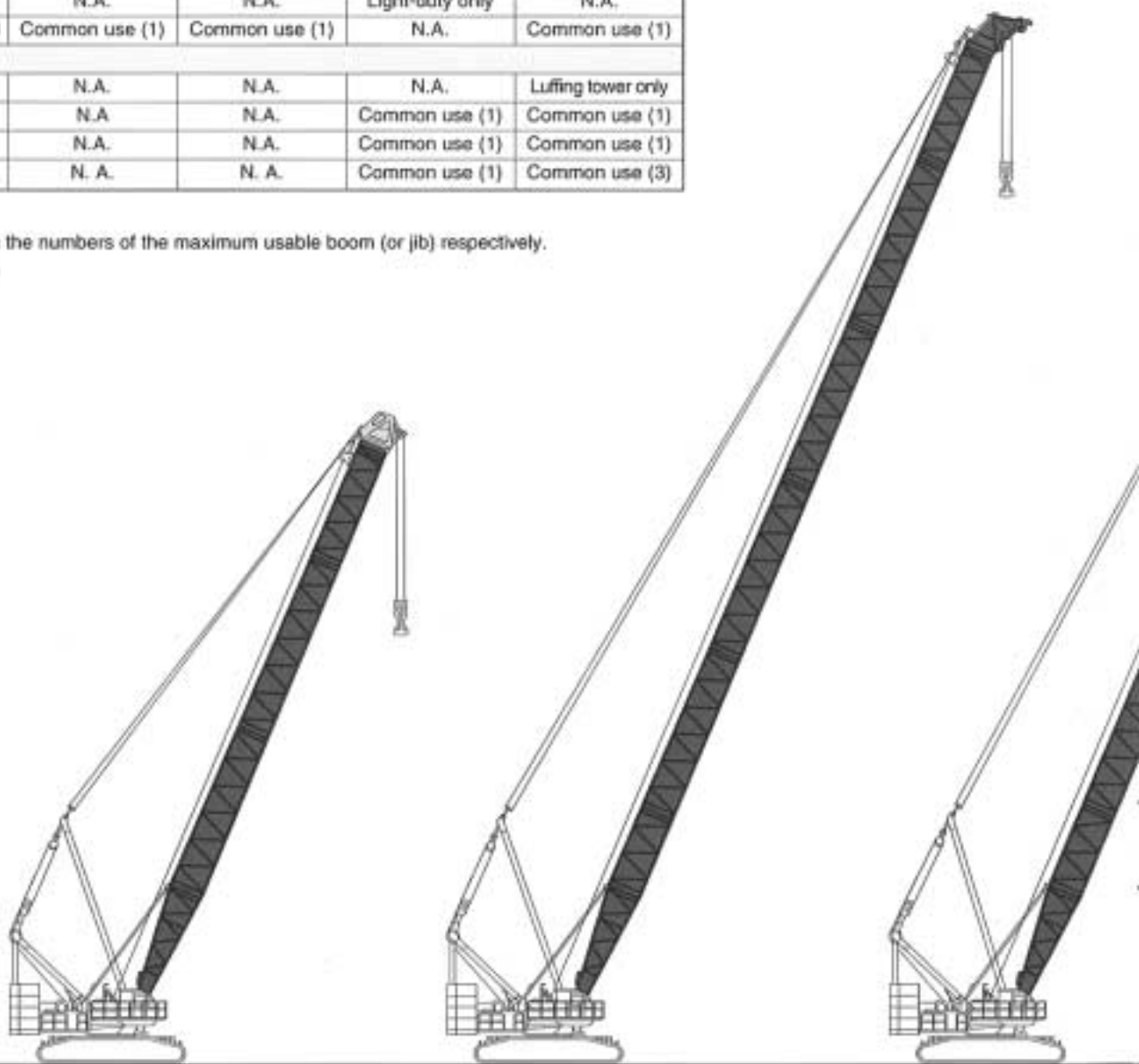

Heavy-duty Lift

Max. Lifting Capacity:

300 metric ton x 5.0 m

Boom Length:

18m (59ft) to 42m (138ft)

Basic Crane

Max. Lifting Capacity:

180 metric ton x 8.0 m

Boom Length:

24m (79ft) to 72m (236ft)

Light-duty Lift

Max. Lifting Capacity:

100 metric ton x 12.0 m

Boom Length:

30m (98ft) to 96m (315ft)

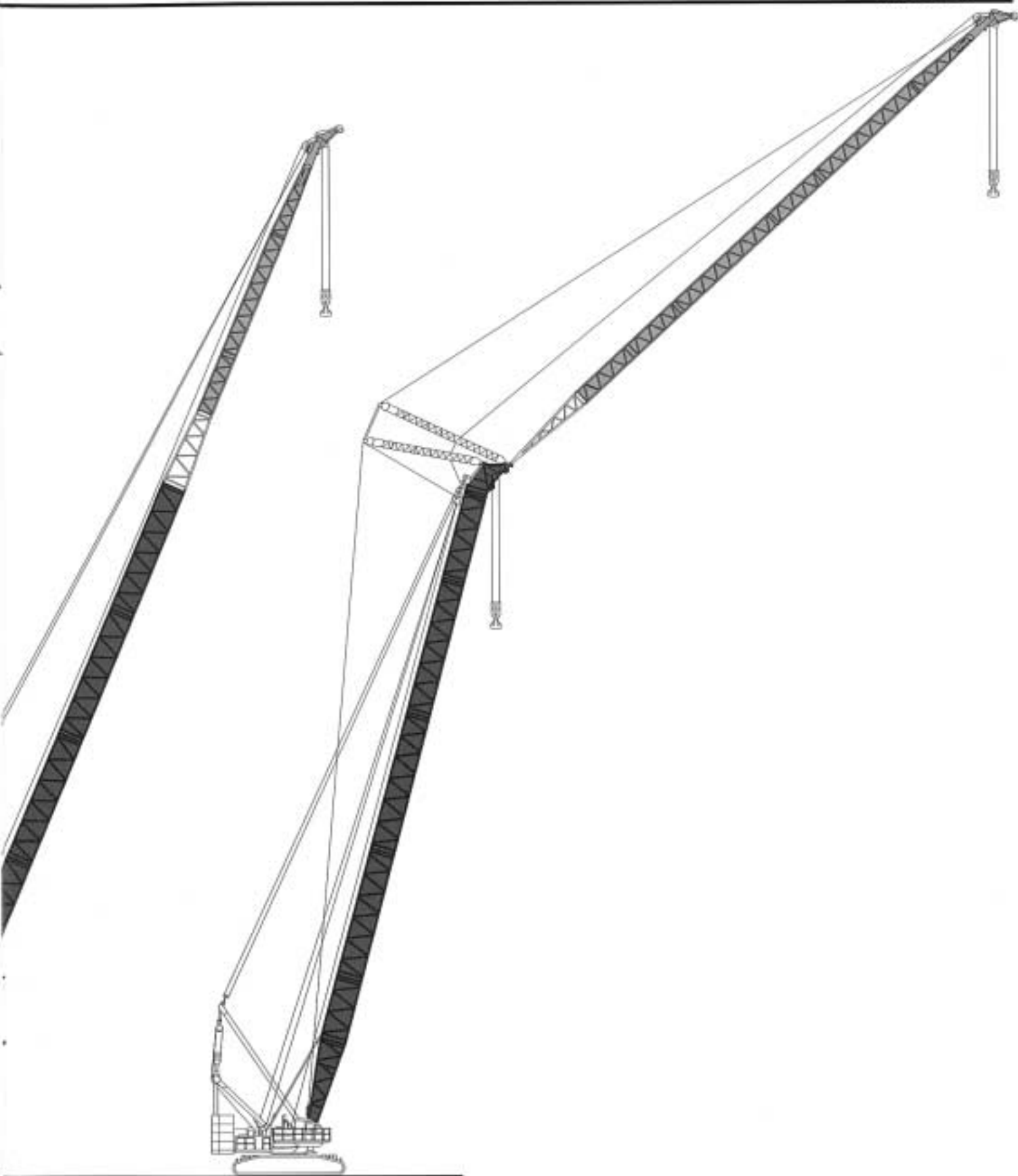

Luffing Tower

Max. Lifting Capacity:

87.5 metric ton x 16.0 m

Tower+ Jib Length:

30m (98ft) + 24m (79ft)

to 60m (197ft) + 60m (197ft)

Specifications

Upper machinery



Power plant

Model Mitsubishi 8DC9-TE1
Type Water-cooled, V-type,
direct fuel injection, with turbocharger

No. of cylinder 8

Bore and stroke 135 mm x 140 mm

Displacement 16.031 liters

Rated power 253.7 kW (345 PS) at 2,000 min⁻¹
(JIS D1005)

Max. torque 1,324 N•m (135 kg-m) at 1,500 min⁻¹
(JIS D1005)

Cooling system Liquid, recirculating bypass

Starter 24 V, 6.0 kW

Generator 24 V, 150 A

Cycles 4

Radiator Vertical tube and fin type core,
thermostatically controlled

Air cleaner Dry type with replaceable paper element

Fuel tank capacity 500 liters

Batteries Two 12V, 200 A-hr capacity batteries,
series connected

Filtration Full flow and by-pass type with
replaceable paper element

Electrical system All wiring corded for easy servicing,
individual fused branch circuits.



Hydraulic system

Pumps: All five pumps are driven by heavy-duty pump drive. Three tandem variable displacement pumps and one displacement pump are used. Two of tandem variable displacement pumps are used in the No.1 and No.2 hoist drum circuit. Another is used in the propel circuit and boom hoist circuit. The one variable displacement pump is used in the swing circuit. In addition, one of three gear pumps are used in the control system and auxiliary equipment.

Control: Electric-over-hydraulic control system for infinitely variable pressure to front and rear drums, and boom hoist. Controls respond instantly to the touch, delivering smooth function operation. Pumped fluid is filtered before returning to pump.

Pressure:

**Load hoist, boom hoist
and propel system** 31.4 MPa (320 kg/cm²)

Swing system 25.5 MPa (260 kg/cm²)

Control system 4.9 MPa (50 kg/cm²)

Reservoir tank capacity 766 liters

Cooling Oil-to-air heat exchanger

Filtration Full flow filters with replaceable
paper elements



Load hoist system

No.1 and No.2 drum for load hoist powered by one hydraulic axial piston motors, each through planetary reducers.

Brakes: Hydraulic counterbalance valve mounted on jib hoist motor and disc type brake, spring set hydraulically release brake and spring set hydraulically release safety pawl.

Drums (No.1 and No.2): 630 mm P.C.D. x 1,019 mm wide drums, each grooved for 28 mm wire rope.

Rope capacity of 600 m working length and 800 m storage length.

Line speed: Single line on the first drum layer

Hook hoist (No.1 drum)

Hoisting 100/46 m/min

Lowering 100/46 m/min

Hook hoist (No.2 drum)

Hoisting 100/46 m/min

Lowering 100/46 m/min



Boom hoist system

Powered by a hydraulic axial piston motor through a planetary reducer.

Brakes: Hydraulic counterbalance valve mounted on jib hoist motor and disc type brake, spring set hydraulically release brake and spring set hydraulically release safety pawl.

Drum: Two drums, grooved for 26 mm dia. wire rope.

Line Speed: Single line on first drum layer

Boom hoist

(Twin-drum is used for boom hoist)

Hoisting 22 m/min x 2

Lowering 22 m/min x 2

Luffing jib hoist

Hoisting 27 m/min

Lowering 27 m/min



Swing system

Swing unit: Powered by hydraulic axial motor driving spur gears through a planetary reducer, the swing system provides 360°

rotation.

Swing speed 1.3 rpm

Swing brake: A spring-set, hydraulically released multiple-disc brake mounted on swing motor.

Service brake: Disk type

Swing circle: Triple-row roller bearing with an internal, integral cut swing gear.

Swing lock: Four-position pin-in-hole lock (manually engaged)



Operator's cab

Independent removable RH cab tilts 15° and elevates 1.3 m by hydraulic cylinders.

Full-vision cab fitted with safety glass, a fixed front window, and sliding LH/RH windows. A fully adjustable, high-backed seat with a head rest permits the operator to set ideal working position. A signal horn, cigarette lighter, windshield wipers, washers, and floor mat are standard features.



Controls

In front of the operator is foot pedal for swing brake, four short hand levers for No.1 and No.2 drum controls, boom hoist control and jib hoist control. At the operator's left are swing control lever and console-mounted control switches. Included are levers for tilting and elevating operator's cab control. Swing brake lock switch and signal horn button are on swing lever. At operator's right are console-mounted two short hand levers for propel, control switches, and hour meter.

Lights: Two front flood lights and one cab inside light

Multi-display Monitor

Gauges and warning signs shown on Multi-display monitor.

Gauges: Fuel, water temperature for engine, optional tachometer

Warning signs: Engine oil pressure, hydraulic oil pressure, water temperature, battery charge, air cleaner, and engine oil filter



Safety devices: Over load safety device, boom over-hoist prevention device (with auto-stop limit function), jib over-hoist prevention device for luffing jib (with auto-stop limit function), No.1 hoist hook over-hoist prevention device, No.2 hoist hook over-hoist prevention device, front strut over-hoist and over-lower prevention device (for luffing jib), boom backstop, rear strut back stop (hydraulic type), jib back stop, swing warning device, propel warning device, function lock lever, hoist drums (No.1, No.2, boom and jib) equipped with hydraulic brake (counterbalance valve), negative disc brake, and lock are provided.



Mast:

Welded construction using high-tensile steel chords and should be attached to the mast foot on the front side of the revolving frame.

The mast is necessary regardless of the boom length.



Gantry

Folding type, fitted with lower spreader for boom hoist reeving, lowers toward rear onto cab roof. Hydraulic lift is standard. Full up, full down positions with linkage.

Counterweight

Nine-piece stack
Total weight 96,000 kg

Carbody counterweight

Four-piece stack
Total weight 22,000 kg



Tools

Tool set and accessories for routine machine maintenance, lubricating tools are provided.



Optional equipment

Reeving winch (with 12 mm dia. x 350 m wire rope), air-conditioner, TV monitor for lifting load, one way call, lamp for front, warning buzzer for swing and propel, mirror for monitoring drum, auxiliary platform (lower structure), boom foot pin cylinder, mast foot pin cylinder, upper machinery connecting pin cylinder, counterweight connecting pin cylinder, crawler frame installation cylinder, lower transflifer cylinder, pillow plates, camera for rear side and left side and drum winch, navigation light of boom, nesting roller and stopper, anemometer, exterior indication light for loading condition, No.1 and No.2 hoist drum rotation indicator, sling materials for assembling and disassembling, foot step for boom and jib, hand rail for boom and jib

Lower machinery

Carbody: Steel-welded carbody with axles.

Crawler: Crawler assemblies designed with a quick disconnect feature for individual removal as a unit from the axles. Crawler belt tension is maintained by hydraulic jack force on the track-adjusting bearing block.

Crawler drive: Independent hydraulic propel drive is built into each side frame. Each drive consists of a hydraulic motor propelling a driving tumbler through a planetary gear box.

Crawler brakes: Spring-set, hydraulically released multiple-disc parking brakes are built into each propel drive.

Steering mechanism: The hydraulic propel system provides both skid steering (driving one track only) and counter-rotating steering (driving tracks in opposite directions).

Track rollers: 13 lower rollers and 2 upper rollers are fitted to each side frame, sealed and maintenance-free.

Shoes:

Number 62 each side
Standard flat shoe width 1,220 mm

Max. travel speed:

High range 1.0 km/h
Low range 0.6 km/h

Max. gradeability: 26.8 %



Weight

Operating weight:

Approx. 284,000 kg
(including 18 m boom and 300-ton hook block)

Ground pressure: 127 kPa (1.29 kg/cm²)
with 1,220 mm shoes



Boom:

Welded lattice construction using tubular, high-tensile steel chords with pin connections between sections.

Heavy-Lift

Max. lifting capacity	300,000 kg
Basic boom length	18 m
Max. boom length	42 m

No. of point sheave..... 13

Basic Crane

Max. lifting capacity	180,000 kg
Basic boom length	24 m
Max. boom length	72 m

No. of point sheave..... 7

Light-duty Lift

Max. lifting capacity	100,000 kg
Basic boom length	30 m
Max. boom length	96 m

No. of point sheave 4



Hook blocks

A range of hook blocks can be specified, with a safety latch.

Lifting capacity	300 ton	180 ton	87.5 ton	25 ton	12.5 ton ball hook
No. of sheaves	13	7	3	1	-
Weight (kg)	5,200	2,600	2,200	1,200	550

Diameter of wire ropes

Standard:

Hook hoist (No.1 drum)	28 mm
Hook hoist (No.2 drum)	28 mm
Boom hoist (20 parts of line reeving)	26 mm
Boom guy line (4 lines)	38 mm

Notes:

- Operating radius is the horizontal distance from the center of rotation to the center of gravity of the load.
- Rated loads shown on the charts are the maximum allowable freely suspended loads at a given boom length, boom angle and radius, and have been determined for the machine standing level on firm supporting surface under ideal operating conditions. The user must limit or de-rate loads to allow for adverse conditions (such as soft or uneven ground, out-of-level conditions, winds, side loads, pendulum action, jerking or sudden stopping of loads, inexperience of personnel, multiple machine lifts, and traveling with a load).
- Capacities do not exceed 75% of minimum tipping loads. Capacities based on factors other than machine stability such as structural competence are indicated by shaded area. Attempt to over load could damage the boom, jib and frame, etc. without tipping.
- The rated loads are determined in accordance with Japanese Regulation.
- Areas on rated charts where no rating are shown, operation is not intended or approved.
- Actual allowable loads of crane boom must not exceed either the maximum load at the each number of reeving mentioned in the following article 8, or the rated loads for the boom length. Actual hoistable loads using the crane boom are determined by deducting the weight of the load handling gear (such as hook block, slings and cables) from the ratings and should not exceed the ratings of the hook block.
- For configurations of insert booms and guy cable

assembly, instructions in the operator's manual must be strictly observed.

8. Max. hoisting load by number of reeving

No. of hoist reeving	1	2	3	4	5	6	7
Max. load (ton)	12.5	25.0	37.5	50.0	62.5	75.0	87.5
No. of hoist reeving	8	9	10	11	12	13	14
Max. load (ton)	100.0	110.0	120.0	135.0	150.0	160.0	180.0
No. of hoist reeving	16	18	20	22	24	26	
Max. load (ton)	200.0	220.0	240.0	260.0	280.0	300.0	

- An auxiliary sheave can be fitted to heavy-duty lift of 18 m to 42 m, basic crane of 24 m to 72 m, and light-duty lift of 30 m to 96 m.
- Rated loads for auxiliary sheave are determined by deducting the auxiliary sheave weight (400 kg for heavy-duty lift; 100 kg for basic crane; 500 kg for light-duty lift) and weight of hook block (550 kg) and load handling gear (sling and cables) from crane boom ratings, but must not exceed a maximum 12.5 ton.
- The maximum operating radius of an auxiliary sheave must not exceed the maximum operating radius of the crane boom in use. The minimum operating radius of an auxiliary sheave is determined by the equivalent boom angle at the minimum operating radius.
- Rated loads for the crane boom with an auxiliary sheave attached are determined by deducting the auxiliary sheave weight from crane boom ratings. Where a 12.5-ton ball hook is fitted, the weight of the hook must also be deducted.

Rated loads in metric tons for 360° working area

Unit: metric ton

Operating radius m	Boom length m (ft)					Operating radius m
	18 (59)	24 (79)	30 (98)	36 (118)	42 (138)	
5	300.0					5
6	251.7	240.0				6
7	213.5	213.5	200.0	180.0		7
8	181.4	181.4	180.0	180.0	150.0	8
9	153.6	162.1	162.1	160.0	150.0	9
10	132.6	140.0	140.0	140.0	140.0	10
12	102.1	108.9	108.9	108.9	108.9	12
14	81.6	87.9	87.9	87.9	87.9	14
16	62.5	73.0	73.0	73.0	72.9	16
18		61.6	61.6	61.6	61.5	18
20		52.5	52.5	52.5	52.5	20
22		45.0	45.0	45.0	45.0	22
24			41.4	41.0	40.6	24
26			36.7	36.6	36.1	26
28			32.2	32.2	32.4	28
30				29.8	29.2	30
34					24.0	34
38					20.4	38

Note: Ratings shown in shaded area are determined by the strength of the boom or other structural components.

Working Ranges

- Actual allowable loads of the crane boom when an auxiliary sheave is attached are determined by deducting the weight of the load handling gear (such as the main hook, slings and cables) from the ratings so determined in the article 11.
- Do not operate the main hook and auxiliary sheave hook simultaneously.
- Refer to the operator's manual for appropriate type of hook block and number of reeving at each boom length.
- When using a light-duty boom of over 90m, an intermediate suspension cable must be used.
- Always have the gantry fully raised and use the backstop during crane operations.
- Boom hoist reeving must be twenty parts of line.
- In principle, the boom should be erected over the front of the crawlers.

The following conditions should be observed:

Boom	Heavy-duty Lift	Basic Crane	Light-duty Lift
Counterweight	96 tons	96 tons	96 tons
Carbody weight	22 tons	22 tons	22 tons
Pillow plates (over the front)	No need	No need	96 m boom

- Figures shown by (ft) in the boom configuration are for reference only.

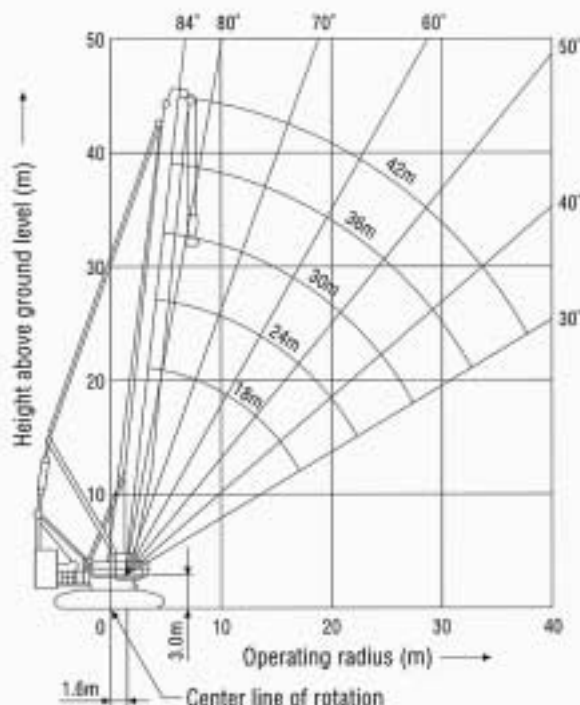

Boom Arrangement

Boom length	Boom arrangement
18 m	Base-B-Tip
24 m	Base-A-B -Tip
30 m	Base-C -B -Tip
36 m	Base-A-C-B-Tip
42 m	Base-C -C -B-Tip

Base = 9.0 m, Tip (Heavy-duty tip) = 1.2 m, Inserts: A = 6.0 m, B (tapered boom) = 7.8 m, C = 12.0 m

Basic Crane Rated Chart

7300
MasterTech

Rated loads in metric tons for 360° working area

Unit: metric ton

Operating radius m	Boom length m (ft)	24 (79)	30 (98)	36 (118)	42 (138)	48 (157)	54 (177)	60 (197)	66 (217)	72 (235)	Boom length m (ft)	Operating radius m
5.5	180.0											5.5
6	180.0											6
7	180.0	180.0	180.0	180.0								7
8	180.0	180.0	180.0	150.0	120.0							8
9	163.5	163.5	160.0	150.0	120.0	110.0						9
10	141.2	141.2	141.2	140.0	120.0	110.0	100.0	87.5				10
12	109.8	109.8	109.8	109.8	109.8	109.8	109.0	100.0	87.5	87.5		12
14	88.7	88.7	88.7	88.7	88.7	88.3	87.8	87.6	87.0	79.4		14
16	73.6	73.4	73.4	73.0	72.6	72.1	71.8	71.4	71.4	64.8		16
18	62.1	62.1	62.0	61.6	61.2	60.7	60.3	59.9	59.9	57.3		18
20	52.9	52.9	52.9	52.9	52.5	52.0	51.6	51.2	51.2	50.8		20
22	45.4	45.4	45.4	45.4	45.4	45.4	45.3	44.9	44.4	44.0		22
24	23.0m/41.9	41.5	41.2	40.7	40.3	39.8	39.4	38.9	38.9	38.5		24
26		37.0	36.8	36.3	35.8	35.3	34.9	34.4	34.4	34.0		26
28		32.6	32.6	32.6	32.1	31.6	31.1	30.6	30.6	30.2		28
30			30.0	29.4	28.9	28.4	28.0	27.5	27.5	27.1		30
34			33.4m/28.1	24.4	23.9	23.3	22.8	22.3	22.3	21.9		34
38				20.6	20.1	19.4	19.0	18.4	18.4	17.9		38
42				38.6m/20.0	17.1	16.4	15.9	15.3	15.3	14.8		42
46					43.8m/15.7	14.0	13.4	12.8	12.8	12.3		46
50						49.0m/12.2	11.4	10.8	10.3	10.3		50
54							9.5	9.1	8.5	8.5		54
58								7.4	6.6	6.6		58
59.4									6.7	6.7		59.4

Note: Ratings shown in shaded area are determined by the strength of the boom or other structural components.

Working Ranges

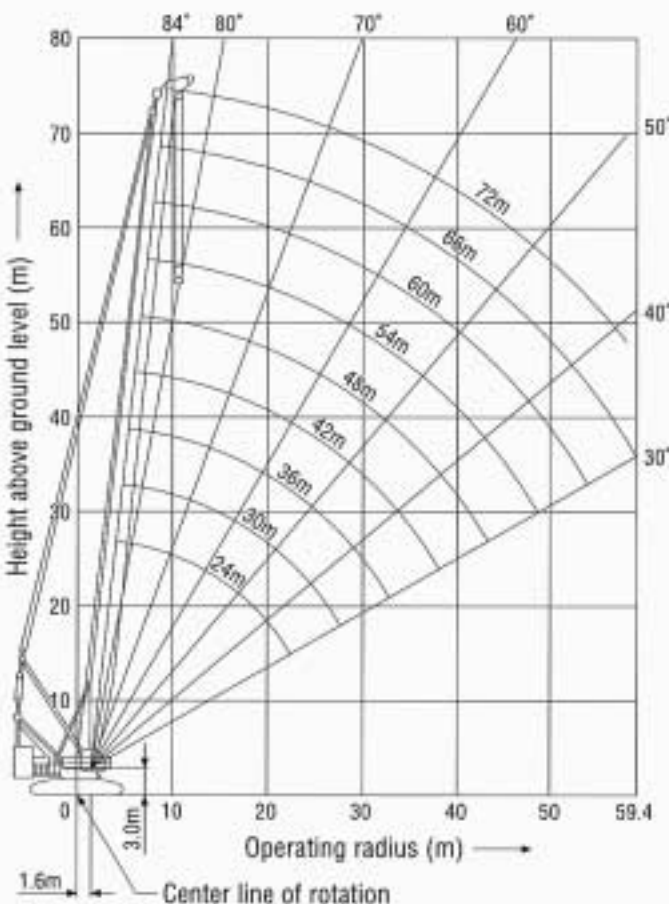

Boom Arrangement

Boom length	Boom arrangement
24 m	Base-A - B - Tip
30 m	Base-C - B - Tip
36 m	Base-A-C - B - Tip
42 m	Base-C - C - B - Tip
48 m	Base-A-C - C - B - Tip
54 m	Base-C - C - C - B - Tip
60 m	Base-A - C - C - C - B - Tip
66 m	Base - C - C - C - C - B - Tip
72 m	Base - A - C - C - C - C - B - Tip

Base = 9.0 m, Tip (Tower tip) = 1.2 m
Inserts: A = 6.0 m, B (tapered boom) = 7.8 m, C = 12.0 m

Light-duty Lift Rated Chart

7300
MasterTech

Rated loads in metric tons for 360° working area

Unit: metric ton

Boom length m (ft) Operating radius m	30 (98)	36 (118)	42 (138)	48 (157)	54 (177)	60 (197)	66 (217)	72 (236)	78 (256)	84 (276)	90 (295)	96 (315)	Boom length m (ft) Operating radius m
5.5	100.0												5.5
6	100.0	100.0											6
7	100.0	100.0	100.0										7
8	100.0	100.0	100.0	100.0	100.0								8
9	100.0	100.0	100.0	100.0	100.0	100.0							9
10	100.0	100.0	100.0	100.0	100.0	97.9	82.7	74.3					10
12	100.0	100.0	100.0	100.0	96.3	90.2	78.6	70.8	58.3	48.6	41.7		12
14	91.7	91.7	91.4	91.3	91.1	82.5	74.5	67.3	57.3	47.7	40.8	34.3	14
16	76.0	76.0	75.6	75.5	75.3	74.8	70.4	63.8	56.3	46.8	39.9	33.5	16
18	64.7	64.5	64.2	64.1	63.8	63.3	62.9	60.3	55.3	45.9	39.0	32.7	18
20	56.1	55.9	55.5	55.4	55.1	54.6	54.2	53.8	51.1	45.0	38.1	31.9	20
22	49.4	49.2	48.7	48.6	48.3	47.8	47.3	46.9	46.6	44.1	35.2	31.1	22
24	44.0	43.7	43.3	43.1	42.8	42.3	41.8	41.4	41.1	40.7	33.0	28.8	24
26	39.6	39.3	38.8	38.7	38.3	37.8	37.3	36.9	36.5	36.2	31.0	27.0	26
28	27.8m/35.6	35.6	35.0	34.9	34.5	34.0	33.5	33.1	32.7	32.4	29.1	25.3	28
30		32.5	31.9	31.7	31.3	30.8	30.3	29.9	29.5	29.1	27.2	23.9	30
34		33.0m/27.8	26.8	26.7	26.2	25.7	25.1	24.7	24.3	23.9	23.6	20.8	34
38			23.0	22.8	22.3	21.7	21.2	20.7	20.3	19.9	19.6	17.9	38
42				19.9	19.2	18.6	18.1	17.6	17.2	16.8	16.4	16.0	42
46				43.4m/18.8	18.8	16.2	15.6	15.1	14.6	14.2	13.8	13.4	46
50					48.6m/15.2	14.1	13.5	13.0	12.5	12.1	11.7	11.2	50
54						53.8m/12.1	11.8	11.3	10.8	10.3	10.0	9.5	54
58							10.4	9.8	9.3	8.8	8.4	7.9	58
62							59.0m/10.0	8.5	8.0	7.5	7.1	6.6	62
66								64.0m/7.8	6.9	6.4	6.0	5.2	66
70									69.4m/5.9	5.3	4.7	4.0	70

Note: Ratings shown in shaded area are determined by the strength of the boom or other structural components.

Working Ranges

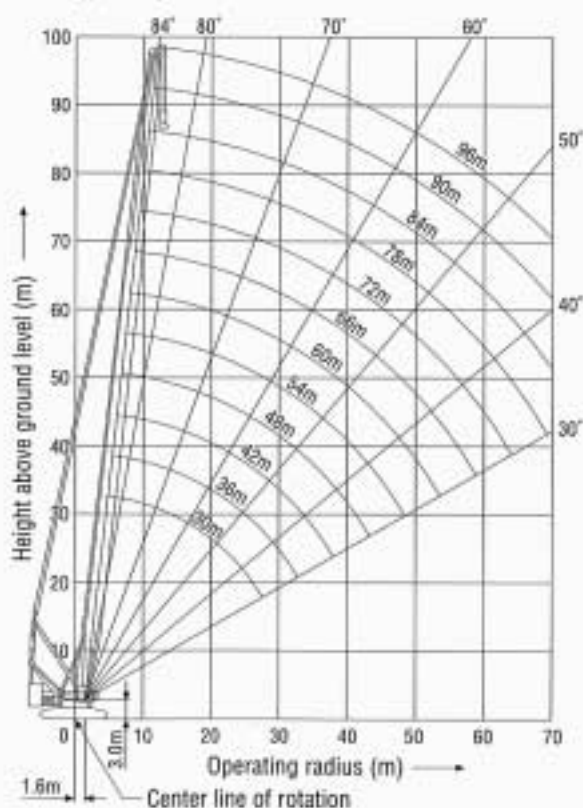

Boom Arrangement

Boom length	Boom arrangement
30 m	Base-A - D - Tip
36 m	Base-C - D - Tip
42 m	Base-A - C - D - Tip
48 m	Base - C - C - D - Tip
54 m	Base-A - C - C - D - Tip
60 m	Base - C - C - C - D - Tip
66 m	Base - A - C - C - C - D - Tip
72 m	Base - C - C - C - C - D - Tip
78 m	Base - A - C - C - C - C - D - Tip
84 m	Base - A - C - C - C - C - D - E - Tip
90 m	Base - A - C - C - C - C - D - F - Tip
96 m	Base - A - C - C - C - C - D - E - F - Tip

Base = 9.0 m , Tip (light-duty tip) = 9.0 m
 Inserts: A = 6.0 m, C = 12.0 m,
 D (tapered boom insert) = 6.0 m, E (luffing jib insert) = 6.0 m,
 F (luffing jib insert) = 12.0 m



Luffing tower:

Welded lattice construction using tubular, high-tensile steel chords with pin connections.

Max. lifting capacity	87.5 tons at 16 m
Basic luffing tower + jib length	30 m + 24 m
Max. luffing tower + jib length	60 m + 60 m

No. of point sheave..... 4



Hook blocks

A range of hook block can be specified, with a safety latch.

Lifting capacity	87.5 tons	25 tons	12.5 tons (ball hook)
No. of sheave	3	1	-
Weight (kg)	2,200	1,200	550

Diameter of wire ropes

Hook hoist (No.1 drum)	28 mm
Hook hoist (No.2 drum)	28 mm
Boom hoist (20 parts of line reeving)	26 mm
Jib hoist (10 parts of line reeving)	26 mm
Boom guy line (4 lines)	38 mm
Jib guy line (2 lines)	44 mm
Strut guy line (2 lines)	44 mm



Weight

Operating weight:

Approx. 300,000 kg

(including 30 m tower, 24 m jib, and 87.5-ton hook block)

Ground pressure: 134 kPa (1.36 kg/cm²) with 1,220 mm shoes

Notes:

- Operating radius is the horizontal distance from the center of rotation to the center of gravity of the load.
- Rated loads included in the charts are the maximum allowable freely suspended loads at a given tower length and jib length, tower and jib angle, and radius, and have been determined for the machine standing level on firm supporting surface under ideal operating conditions. The user must limit or de-rate loads to allow for adverse conditions (such as soft or uneven ground, out-of-level conditions, winds, side loads, pendulum action, jerking or sudden stopping of loads, inexperience of personnel, multiple machine lifts, and traveling with a load).
- Capacities do not exceed 75% of minimum tipping loads. Capacities based on factors other than machine stability such as structural competence are indicated by shaded area. Attempt to over load could damage the boom, jib and frame, etc. without tipping.
- The rated loads are determined in accordance with Japanese Regulation.
- Areas on rated charts where no rating are shown, operation is not intended or approved.
- Actual allowable loads of tower jib must not exceed either the maximum load at the each number of reeving mentioned in the following article 9, or the rated loads for the boom length. Actual hoistable loads using the tower jib are determined by deducting the weight of the load-

handling gear (such as hook block, slings and cables) from the ratings and should not exceed the ratings for the hook block.

- For configurations of insert booms and guy cable assembly, instructions in the operator's manual must be strictly observed.
- When operating luffing tower, jib angle must be maintained between 20° to 73° from the horizontal line at the each fixed tower angle (66°, 76° and 86°).
- Max. hoisting load by number of reeving

No. of hoist reeving	1	2	3	4	5	6	7
Max. load (ton)	12.5	25.0	37.5	50.0	62.5	75.0	87.5

- An auxiliary sheave can be fitted to luffing tower of 30 m tower + 24 m jib, to 60 m tower + 60 m jib.
- Rated loads for auxiliary sheave are determined by deducting the auxiliary sheave weight (500 kg) and weight of hook block (550 kg) and load handling gear (sling and cables) from luffing tower ratings, but must not exceed a maximum 12.5 ton.
- The maximum operating radius of an auxiliary sheave must not exceed the maximum operating radius of the luffing tower. The minimum operating radius of the auxiliary sheave is determined by the equivalent angles of boom and jib at the minimum radius.
- Rated loads for the tower jib with an auxiliary sheave

Working Ranges

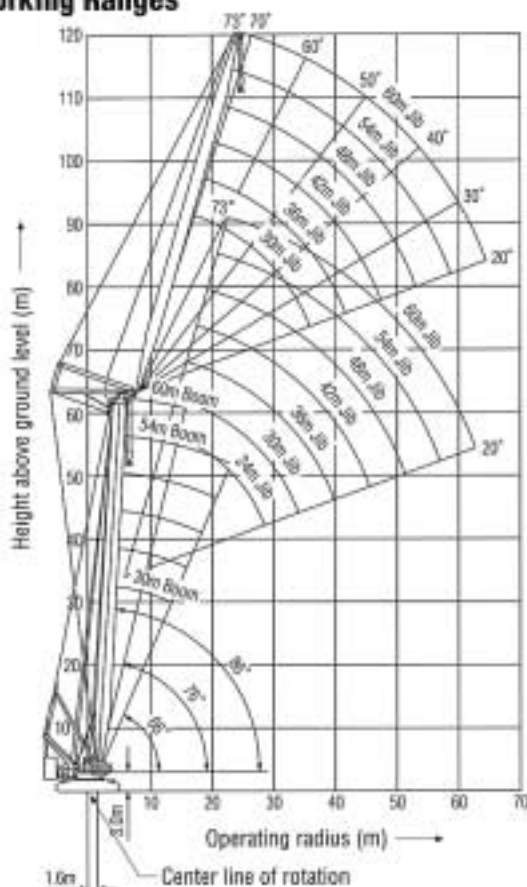

Tower Boom Arrangement

Tower boom length	Tower boom arrangement
30 m	Base-C-B-Tip
36 m	Base-A-C-B-Tip
42 m	Base-C-C-B-Tip
48 m	Base-A-C-C-B-Tip
54 m	Base-C-C-C-B-Tip
60 m	Base-A-C-C-C-B-Tip

Base = 9.0 m, Tip (Tower boom tip) = 1.2 m
 Inserts: A = 6.0 m, B (tapered boom) = 7.8 m, C = 12.0 m

Jib Arrangement

Jib length	Jib arrangement
24 m	Base-E-Jib tip
30 m	Base-F-Jib tip
36 m	Base-E-F-Jib tip
42 m	Base-F-F-Jib tip
48 m	Base-E-F-F-Jib tip
54 m	Base-F-F-F-Jib tip
60 m	Base-E-F-F-F-Jib tip

Base (jib base) = 9.0 m, Jib tip (light-duty tip) = 9.0 m
 Inserts (jib): E (luffing jib insert) = 6.0 m, F (luffing jib insert) = 12.0 m

Tower Boom and Jib Combinations and Allowable Tower Boom Angle

Tower boom length	24 m jib	30 m jib	36 m jib	42 m jib	54 m jib	60 m jib
30 m	66° - 86°	66° - 86°	66° - 86°	66° - 86°	66° - 86°	66° - 86°
36 m	66° - 86°	66° - 86°	66° - 86°	66° - 86°	66° - 86°	66° - 86°
42 m	66° - 86°	66° - 86°	66° - 86°	66° - 86°	66° - 86°	66° - 86°
48 m	-	66° - 86°	66° - 86°	66° - 86°	76° - 86°	76° - 86°
54 m	-	66° - 86°	66° - 86°	76° - 86°	76° - 86°	76° - 86°
60 m	-	76° - 86°	76° - 86°	76° - 86°	76° - 86°	76° - 86°

attached are determined by deducting the sheave weight from luffing tower ratings. Where a 12.5-ton ball hook is fitted, the weight of the hook must also be deducted.

14. Actual allowable loads of the tower jib when an auxiliary sheave is attached are determined by deducting the weight of the load handling gear (such as hook block, slings and cables) from the ratings so determined in the article 12.
15. Do not operate the main hook and auxiliary sheave hook simultaneously.
16. Refer to the operator's manual for appropriate type of hook block and number of reeving at each luffing tower length.
17. Always have the gantry fully raised and use the backstop during luffing tower operations.
18. Boom hoist reeving must be twenty parts of line.
19. Jib hoist reeving must be ten parts of line.
20. The weights of standard counterweight and carbody counterweight are as follows:
 Standard counterweight; 96 tons,
 Standard carbody counterweight; 22 tons.
21. In principle, the boom should be erected over the front of the crawlers.
22. When tower length is over 60 m, pillow plates for crawlers must be used for erection.
23. Figures shown by (ft) in the boom configuration are for reference only.

Luffing Tower Rated Charts

(1) 30 m luffing tower rated loads in metric tons for 360° working area

Unit: metric ton

Operating radius (m)	30 m (98 ft) Tower Boom												Operating radius (m)
	24 m (79 ft) Jib			30 m (98 ft) Jib			36 m (118 ft) Jib			42 m (138 ft) Jib			
	Tower angle			Tower angle			Tower angle			Tower angle			
	86°	76°	66°	86°	76°	66°	86°	76°	66°	86°	76°	66°	
14	87.5												14
16	87.5			87.5									16
18	79.0			78.8			75.0						18
20	68.5			68.3			67.9			61.4			20
22	60.3			60.2			59.8			59.3			22
24	53.8	49.6		53.7			53.3			53.4			24
26	48.4	44.7		48.4	44.4		48.0			48.1			26
28	43.6	40.6		43.9	40.3		43.6			43.7			28
30		37.1		40.2	36.9		39.9	36.4		39.9			30
34		31.5	28.9	32.6	31.4		34.0	30.9		34.0	30.9		34
38			25.0		27.2	24.7	29.1	26.8		29.5	26.7		38
42						21.7		23.5	21.1	25.5	23.4		42
46									18.8		20.8	18.7	46
50									16.8		18.6	16.7	50
54												15.0	54
Part reeving	7			7			7			6			Part reeving

Note: Ratings shown in shaded area are determined by the strength of the boom or other structural components.

Operating radius (m)	30 m (98 ft) Tower Boom									Operating radius (m)
	48 m (157 ft) Jib			54 m (177 ft) Jib			60 m (197 ft) Jib			
	Tower angle			Tower angle			Tower angle			
	86°	76°	66°	86°	76°	66°	86°	76°	66°	
22	50.0									22
24	48.9			40.4						24
26	47.3			37.8			29.8			26
28	43.3			35.5			27.9			28
30	39.6			33.4			26.2			30
34	33.6	30.4		29.9			23.3			34
38	29.1	26.3		27.0	26.1		21.0			38
42	25.3	23.0		24.6	22.8		18.9	18.9		42
46	21.9	20.3	18.2	22.0	20.2		17.2	17.2		46
50	19.0	18.2	16.2	19.2	18.0	16.0	15.8	15.8		50
54		16.4	14.5	16.9	16.2	14.3	14.5	14.5	14.0	54
58			13.1		14.6	12.9	13.5	13.5	12.6	58
62					13.3	11.7	11.8	11.6	11.4	62
66						10.7		10.5	10.4	66
70									9.5	70
Part reeving	4			4			3			Part reeving

Note: Ratings shown in shaded area are determined by the strength of the boom or other structural components.

(2) 36 m luffing tower rated loads in metric tons for 360° working area

Unit: metric ton

Operating radius (m)	36 m (118 ft) Tower Boom												Operating radius (m)
	24 m (79 ft) Jib			30 m (96 ft) Jib			36 m (118 ft) Jib			42 m (138 ft) Jib			
	Tower angle			Tower angle			Tower angle			Tower angle			
	86°	76°	66°	86°	76°	66°	86°	76°	66°	86°	76°	66°	
16	87.5			87.5									16
18	78.6			78.4			75.0						18
20	68.1			67.9			67.5			61.7			20
22	60.0			59.8			59.4			59.5			22
24	53.5			53.3			53.0			53.1			24
26	48.1	43.4		48.1			47.7			47.8			26
28	43.7	39.4		43.7	39.1		43.3			43.4			28
30		36.0		39.9	35.7		39.6	35.2		39.7			30
34		30.6	27.2	34.0	30.3		33.7	29.9		33.8	29.9		34
38			23.5		26.3	23.2	29.2	25.8		29.2	25.8		38
42						20.3		22.6	19.8	25.7	22.6		42
46						18.0		20.1	17.5	21.4	20.0	17.4	46
50									15.6		17.9	15.5	50
54												13.9	54
58												12.6	58
Part reeving		7			7			6			5		Part reeving

Note: Ratings shown in shaded area are determined by the strength of the boom or other structural components.

Operating radius (m)	36 m (118 ft) Tower Boom									Operating radius (m)
	48 m (157 ft) Jib			54 m (177 ft) Jib			60 m (197 ft) Jib			
	Tower angle			Tower angle			Tower angle			
	86°	76°	66°	86°	76°	66°	86°	76°	66°	
22	50.0									22
24	49.1			40.9						24
26	47.4			38.2			30.2			26
28	43.0			35.8			28.3			28
30	39.3			33.7			26.5			30
34	33.4			30.2			23.6			34
38	28.9	25.3		27.2	25.1		21.1			38
42	25.3	22.1		24.8	22.0		19.1	19.1		42
46	22.1	19.6		22.2	19.4		17.3	17.3		46
50	19.3	17.5	15.0	19.4	17.3		15.9	15.9		50
54		15.7	13.4	17.0	15.5	13.2	14.6	14.6		54
58		14.2	12.1		14.0	11.8	13.4	13.4	11.6	58
62			11.0		12.7	10.7	11.4	11.4	10.4	62
66						9.7		10.2	9.3	66
70									8.3	70
74									7.5	74
Part reeving		4			4			3		Part reeving

Note: Ratings shown in shaded area are determined by the strength of the boom or other structural components.

Luffing Tower Rated Charts

(3) 42 m luffing tower rated loads in metric tons for 360° working area

Unit: metric ton

Operating radius (m)	42 m (138 ft) Tower Boom												Operating radius (m)
	24 m (78 ft) Jib			30 m (98 ft) Jib			36 m (118 ft) Jib			42 m (138 ft) Jib			
	Tower angle			Tower angle			Tower angle			Tower angle			
	86°	76°	66°	86°	76°	66°	86°	76°	66°	86°	76°	66°	
16	87.5												16
18	78.1			75.0			75.0						18
20	67.7			67.5			67.1			62.1			20
22	59.6			59.4			59.0			59.1			22
24	53.1			53.0			52.6			52.7			24
26	47.8	41.9		47.7			47.3			47.4			26
28	43.4	38.1		43.3			43.0			43.1			28
30		34.8		39.6	34.4		39.3			39.4			30
34		29.5		33.7	29.2		33.4	28.7		33.5	28.7		34
38			21.9		25.3		28.9	24.8		29.0	24.8		38
42			19.1		22.1	18.8		21.7		25.4	21.7		42
46						16.6		19.2	16.0	22.2	19.2		46
50									14.3		17.1	14.2	50
54												12.7	54
58												11.5	58
Part reeving	7			6			6			5			Part reeving

Note: Ratings shown in shaded area are determined by the strength of the boom or other structural components.

Operating radius (m)	42 m (138 ft) Tower Boom									Operating radius (m)
	48 m (157 ft) Jib			54 m (177 ft) Jib			60 m (197 ft) Jib			
	Tower angle			Tower angle			Tower angle			
	86°	76°	66°	86°	76°	66°	86°	76°	66°	
22	51.1									22
24	49.4			41.4						24
26	47.0			38.7			30.6			26
28	42.7			36.2			28.6			28
30	39.0			34.1			26.8			30
34	33.1			30.4			23.8			34
38	28.6	24.3		27.4			21.3			38
42	25.1	21.2		24.9	21.0		19.2			42
46	22.2	18.7		22.1	18.5		17.4	17.4		46
50	19.4	16.7		19.6	16.5		15.9	15.9		50
54		15.0	12.1	17.0	14.8		14.7	14.6		54
58		13.5	10.7		13.3	10.4	13.4	13.1	10.1	58
62			9.6		12.1	9.3	11.3	11.3	8.9	62
66			8.6			8.2		10.1	7.9	66
70						7.4		8.5	7.0	70
74									6.2	74
Part reeving	5			4			3			Part reeving

Note: Ratings shown in shaded area are determined by the strength of the boom or other structural components.

(4) 48 m luffing tower rated loads in metric tons for 360° working area

Unit: metric ton

Operating radius (m)	48 m (157 ft) Tower Boom												Operating radius (m)
	30 m (98 ft) Jib			36 m (118 ft) Jib			42 m (138 ft) Jib			48 m (157 ft) Jib			
	Tower angle			Tower angle			Tower angle			Tower angle			
	86°	76°	66°	86°	76°	66°	86°	76°	66°	86°	76°	66°	
18	75.0												18
20	67.0			62.5									20
22	58.9			56.8			56.2			51.3			22
24	52.5			52.4			52.3			49.6			24
26	47.3			47.1			47.1			46.6			26
28	42.9			42.8			42.7			42.3			28
30	39.3	33.0		39.1			39.0			38.6			30
34	33.4	28.0		33.3	27.7		33.2			32.8			34
38		24.1		28.8	23.9		28.7	23.7		28.3			38
42		21.1			20.9		25.2	20.7		24.8	20.2		42
46			14.4		18.4	13.9	22.3	18.3		22.0	17.8		46
50			12.8			12.2		16.3	11.9	19.6	15.8		50
54						10.9		14.6	10.5		14.2	9.7	54
58									9.3		12.8	8.6	58
62									8.4			7.6	62
66												6.8	66
Part reeving	6			5			5			5			Part reeving

Note: Ratings shown in shaded area are determined by the strength of the boom or other structural components.

Operating radius (m)	48 m (157 ft) Tower Boom						Operating radius (m)
	54 m (177 ft) Jib			60 m (197 ft) Jib			
	Tower angle			Tower angle			
	86°	76°	-	86°	76°	-	
24	41.9						24
26	39.1			31.0			26
28	36.6			28.9			28
30	34.4			27.1			30
34	30.7			24.0			34
38	27.6			21.5			38
42	24.7	20.1		19.4			42
46	21.9	17.6		17.6	17.4		46
50	19.5	15.6		16.0	15.4		50
54	17.1	14.0		14.7	13.8		54
58	14.6	12.6		13.4	12.4		58
62		11.4		11.3	11.1		62
66		10.4			10.0		66
70					9.0		70
Part reeving	4			3			Part reeving

Note: Ratings shown in shaded area are determined by the strength of the boom or other structural components.

Luffing Tower Rated Charts

(5) 54 m luffing tower rated loads in metric tons for 360° working area

Unit: metric ton

Operating radius (m)	54 m (177 ft) Tower Boom												Operating radius (m)
	30 m (98 ft) Jib			36 m (118 ft) Jib			42 m (138 ft) Jib			48 m (157 ft) Jib			
	Tower angle			Tower angle			Tower angle			Tower angle			
	86°	76°	66°	86°	76°	66°	86°	76°	-	86°	76°	-	
18	62.5												18
20	62.5			62.5									20
22	58.4			58.3			57.6						22
24	52.1			51.9			51.8			49.7			24
26	46.9			46.7			46.6			46.5			26
28	42.5			42.4			42.3			42.2			28
30	38.9			38.7			38.7			38.5			30
34	33.0	26.5		32.9			32.8			32.7			34
38		22.9		28.5	22.4		28.4	22.2		28.3			38
42		20.0			19.6		24.9	19.3		24.8	19.0		42
46			11.6		17.3		22.1	17.0		21.9	16.6		46
50			10.2		15.4	9.6		15.1		19.6	14.7		50
54			9.0			8.4		13.5			13.1		54
58						7.4					11.7		58
62											10.6		62
Part reeving	5			5			5			4			Part reeving

Note: Ratings shown in shaded area are determined by the strength of the boom or other structural components.

Operating radius (m)	54 m (177 ft) Tower Boom						Operating radius (m)
	54 m (177 ft) Jib			60m (197 ft) Jib			
	Tower angle			Tower angle			
	86°	76°	-	86°	76°	-	
26	39.6			31.4			26
28	37.1			29.3			28
30	34.8			27.4			30
34	31.0			24.2			34
38	27.8			21.7			38
42	24.4			19.5			42
46	21.6	16.0		17.7	15.8		46
50	19.3	14.1		16.1	13.9		50
54	17.3	12.5		14.8	12.2		54
58	14.7	11.1		13.5	10.8		58
62		9.9		11.3	9.6		62
66		8.9			8.6		66
70					7.7		70
Part reeving	4			3			Part reeving

Note: Ratings shown in shaded area are determined by the strength of the boom or other structural components.

(6) 60 m luffing tower rated loads in metric tons for 360° working area

Unit: metric ton

Operating radius (m)	60 m (197 ft) Tower Boom												Operating radius (m)
	30 m (98 ft) Jib			36 m (118 ft) Jib			42 m (138 ft) Jib			48 m (157 ft) Jib			
	Tower angle			Tower angle			Tower angle			Tower angle			
	86°	76°	-	86°	76°	-	86°	76°	-	86°	76°	-	
18	62.5												18
20	62.5			62.5									20
22	57.8			57.7			50.0						22
24	51.5			51.4			50.0			50.0			24
26	46.4			46.2			46.1			45.7			26
28	42.1			41.9			41.9			41.4			28
30	38.4			38.3			38.2			37.8			30
34	32.6	23.8		32.5			32.5			32.0			34
38		20.5		28.1	20.1		28.1			27.6			38
42		17.9		24.6	17.4		24.6	17.2		24.2	16.4		42
46		15.7			15.3		21.8	15.0		21.4	14.2		46
50					13.5			13.2		19.1	12.5		50
54								11.8			11.0		54
58								10.5			9.8		58
62											8.7		62
Part reeving	5			5			4			4			Part reeving

Note: Ratings shown in shaded area are determined by the strength of the boom or other structural components.

Operating radius (m)	60 m (197 ft) Tower Boom						Operating radius (m)
	54 m (177 ft) Jib			60 m (197 ft) Jib			
	Tower angle			Tower angle			
	86°	76°	-	86°	76°	-	
26	40.1						26
28	37.5			29.6			28
30	35.2			27.7			30
34	31.2			24.5			34
38	27.6			21.8			38
42	24.1			19.6			42
46	21.3	14.0		17.8			46
50	19.0	12.3		16.2	12.0		50
54	17.1	10.8		14.9	10.5		54
58	14.9	9.5		13.6	9.3		58
62		8.5		11.4	8.2		62
66		7.5			7.2		66
70					6.4		70
74					5.7		74
Part reeving	4			3			Part reeving

Note: Ratings shown in shaded area are determined by the strength of the boom or other structural components.

Disassembly & Transportation

Disassembly Procedures

(1) Remove Counterweight & attachment off.

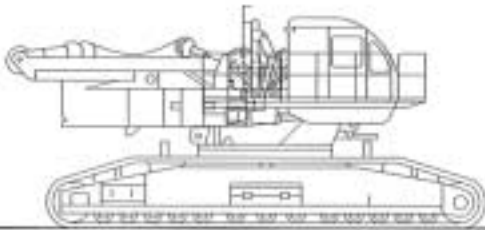

(5) Remove the other crawler off.

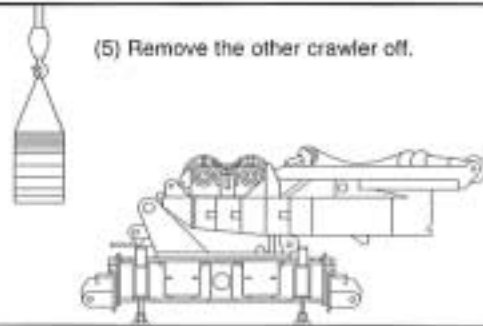

(2) Activate transliifter cylinders (option) and jack up.

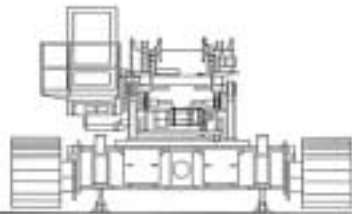

(6) Retract transliifter cylinders and remove winch unit.

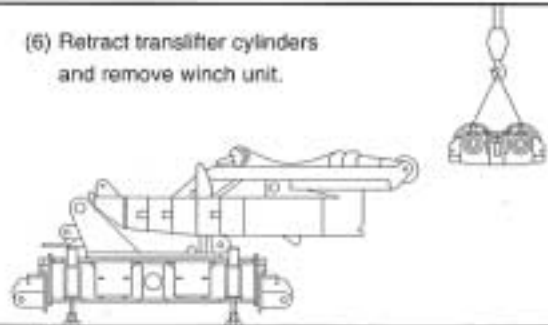

(3) Remove the crawler off on the opposite side from operator's cab.

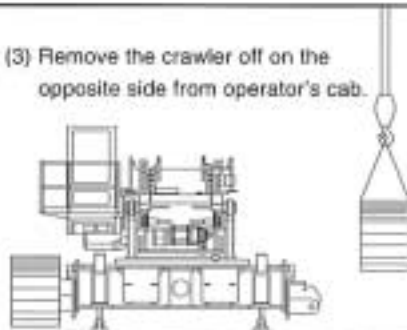

(7) Remove upper frame off.

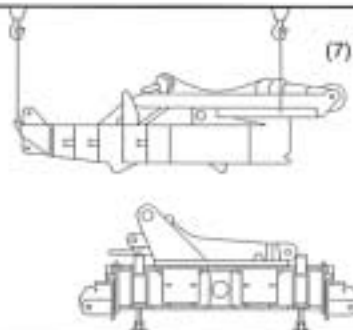

(4) Rotate upper frame 90° and then remove operator's cab off.

* Upper frame cannot be rotated after cab has been removed.



(8) Remove carbody weight off.

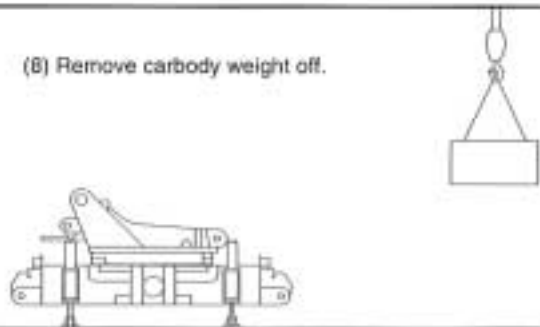

(9) Load center frame slowly onto trailer bed, and then remove transliifter cylinders and floats.

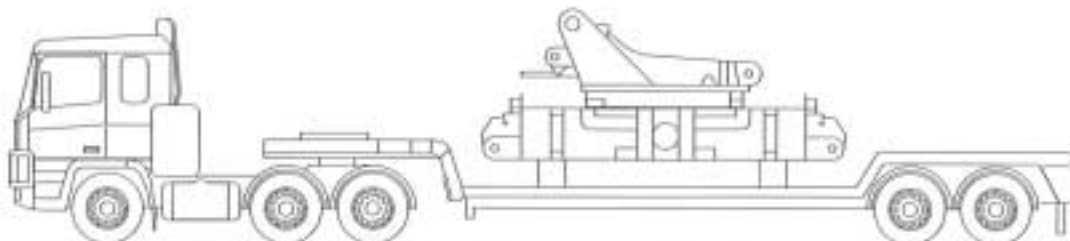

REMARKS: Transliifter cylinders are optional.

Weight and Measurement for Transportation

Base Machine

Upper Frame
Weight: 35.0 ton x 1

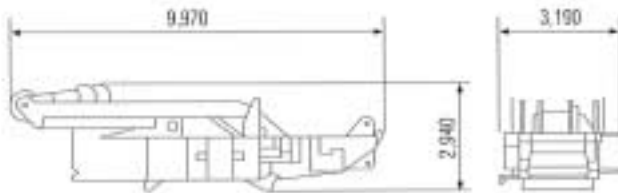

*Includes gantry, lower spreader, boom hoist unit (2) and jib hoist unit (1).

Operator's Cab

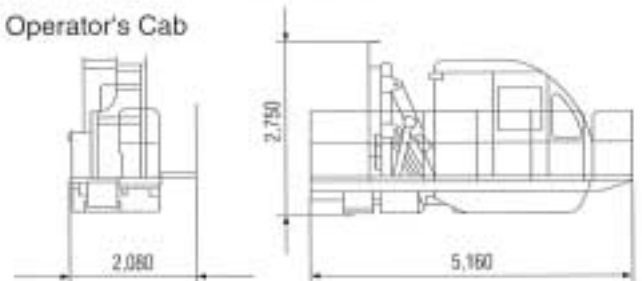

Weight: 3.0 ton x 1 *Includes base, platform

Center Frame, Carbody
Weight: 33.0 ton x 1

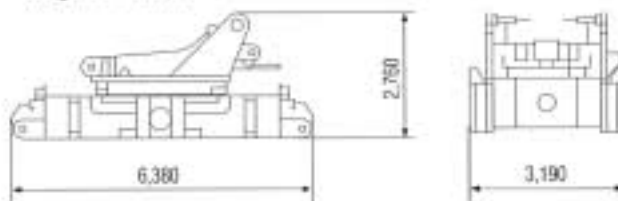

*Includes reeving winch, swing unit, and swing bearing.

Carbody Weight Base

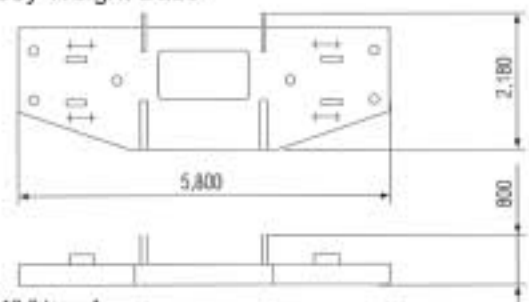

Weight: 12.0 ton x 1

Crawlers

Weight: 30.0 ton x each side

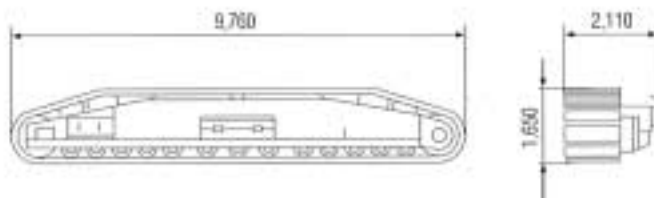

Counterweight

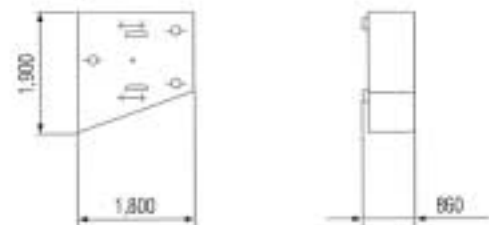

Weight: 10.5 ton x 4 x each side

Cylinder for Translifter

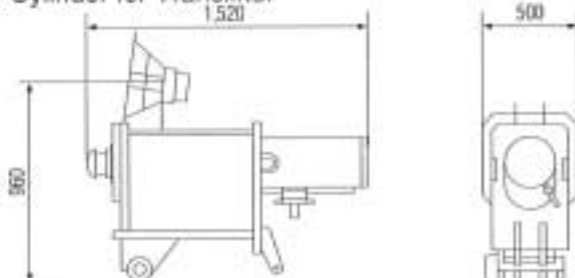

Weight: 0.9 ton x 4 * Includes the float

Carbody Counterweight

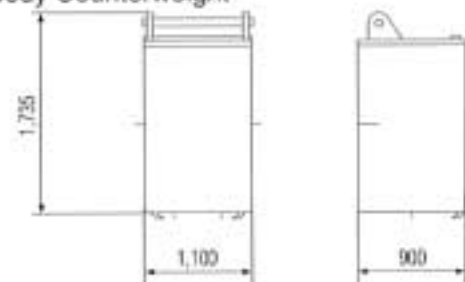

Weight: 5.5 ton x 4

Hoist Winch Unit

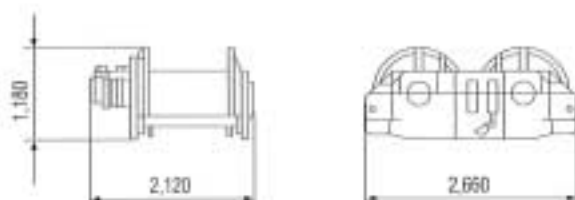

Weight: 10.5 ton x 1 * Includes the wire rope (φ 28 mm x 600 m)

Weight and Measurement for Transportation

Attachment

Description	Width x Height x Length (mm)	Weight (metric ton)	Remarks
Hook			
300-ton hook	780 x 1,570 x 2,640	5.2	
180-ton hook	760 x 1,020 x 2,250	2.6	
87.5-ton hook	760 x 570 x 1,970	2.2	
25-ton hook	750 x 430 x 1,550	1.2	
12.5-ton ball hook	370 dia. x 1,350	0.55	
Boom, Jib, Aux. Sheave			
Mast	2,160 x 1,730 x 13,120	5.2	Including mast foot-pin, upper spreader, and link
Lower boom	2,566 x 2,470 x 9,260	6.0	Including cable reel, back stop
Basic Crane boom	2,180 x 3,850 x 3,240	4.2	Including point sheave, idler sheave, aux. sheave, and link
Heavy-duty tip	2,160 x 2,170 x 3,130	3.9	Including point sheave, idler sheave, and link
6 m insert boom	2,570 x 2,460 x 6,140	2.0	
12 m insert boom	2,570 x 2,460 x 12,140	3.6	
6 m tapered insert boom	2,540 x 2,320 x 6,130	0.9	Light-duty boom only use.
7.8 m tapered insert boom	2,560 x 3,030 x 7,940	3.0	Including idler sheave, backstop, and link
Lower jib	2,340 x 1,720 x 9,210	1.9	Including cable reel
Light-duty tip	2,120 x 1,930 x 9,650	2.5	Compatible with upper boom of light-duty boom.
6 m insert jib	2,120 x 1,810 x 6,120	0.9	Compatible with upper boom of light-duty boom.
12 m insert jib	2,120 x 1,810 x 12,120	1.4	Compatible with upper boom of light-duty boom.
Aux. sheave for luffing tower	810 x 1,210 x 2,410	0.5	Including point sheave
Strut, Backstop, etc.			
Front strut	1,330 x 920 x 12,330	2.0	Including point sheave, idler sheave, foot-pin, and link
Rear strut	1,330 x 1,330 x 10,510	2.5	Including strut backstop, point sheave, idler sheave, foot-pin, and link
Jib backstop	460 x 300 x 3,280	0.13	1 (each side)
Jib tip roller	1,280 x 1,450 x 1,810	0.7	

NOTE: Due to our policy of continual product improvement, all designs and specifications are subject to change without advance notice.

KOBELCO CONSTRUCTION MACHINERY CO., LTD.

17-1, Higashigotanda 2-chome, Shinagawa-ku, Tokyo, 141-8626 JAPAN

Tel: ++81 (0) 3-5789-2124 / Fax: ++81 (0) 3-5789-2137