

NATIONAL SERIES 300

Truck-mounted telescoping cranes
and accessories

Maximum sheave height: 62 feet/18.9 meters
Maximum capacity: 16,000 pounds/7.3 metric tons



NATIONAL SERIES 300

Now looking better than ever.

National is America's largest maker of truck-mounted telescoping and articulating cranes. We build cranes for virtually every job. And now we're looking better than ever.

Our Series 300 gives you the great new look of National and everything else you're looking for in a tough, compact crane. Strong construction. Wide, stable stance. Low truck requirements. Extra reach. Greater capacity. And extra control. All the things you expect from a leader.

Stronger Booms.

Extra strength and lower boom weight mean greater capacity for you, so Series 300 telescoping boom sections are made strong, yet light, fabricated from four high strength steel members welded with perpendicular corners. This box-section construction lets us use thicker top and bottom plates for extra strength. And thinner side plates for increased capacity through lower boom weight. Now, even stronger, low alloy steel is used, welded with advanced, automatic low hydrogen techniques for extra strong seams. Corner seams are ultrasonically tested for proper penetration.

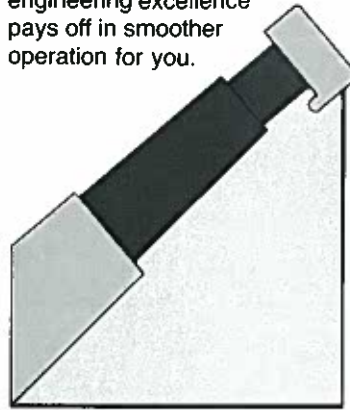

Sequential Extension.

National introduced sequential extension to the industry. Our boom section interlock provides sequential extension, even under full-load. Larger, stronger boom sections extend first, for greater strength. Our locks are mechanical, not hydraulic like others', for greater reliability with no excessive noise or wasted hydraulic power. Just another example of how our attention to engineering excellence pays off in smoother operation for you.

Dual Controls.

Dual controls are standard. There's no extra charge for the safer operation and greater load visibility you get with the Series 300. The fine metering and lower spool forces give you smoother, more precise control.

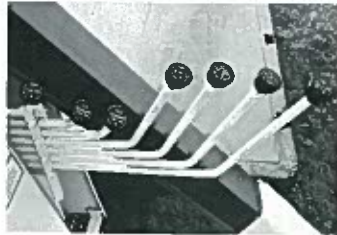

Positive Turret Rotation.

Our Series 300 turret drive is built with extra heavy bearings both above and below the drive pinion. This ensures constant tooth alignment for smooth rotation and low wear. Even under maximum loads. The entire turret glides smoothly on a low inertia ball bearing race. Rotation is 375° noncontinuous.

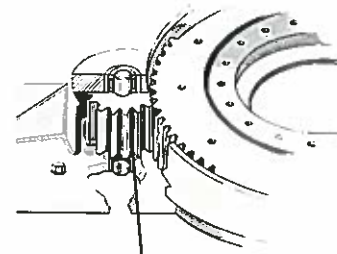

Wide Stance.

We've given our 300 the famous National out-and-down outriggers with a wider 13' 6" stance and better leveling on uneven ground. They give you greater strength and stability with less unit weight, so you can carry larger payloads. The outriggers retract smoothly, without binding under load, first moving up, then in.

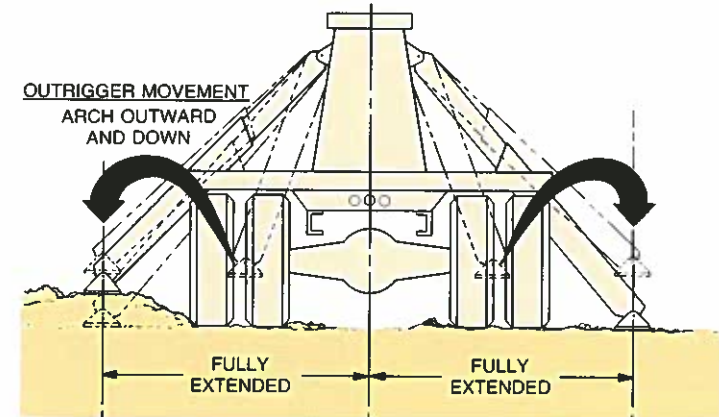

NATIONAL'S "OUT-AND-DOWN" STABLE OUTRIGGERS

- OUTRIGGERS EQUALLY SPACED FROM CRANE CENTER LINE
- CONSISTANT OUTRIGGER SPAN
- CRANE WILL BE EQUALLY STABLE ON BOTH SIDES

Less Space.

The National 300 Series is built tough, but compact, so it fits in just 30 inches of bed space. In fact, you can add our optional crosswalk and take up no more room than comparable cranes. That leaves more payload space and makes the Series 300 even more versatile.

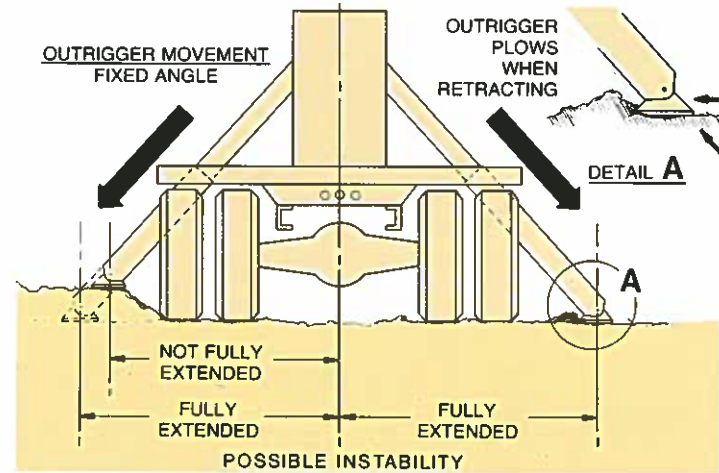
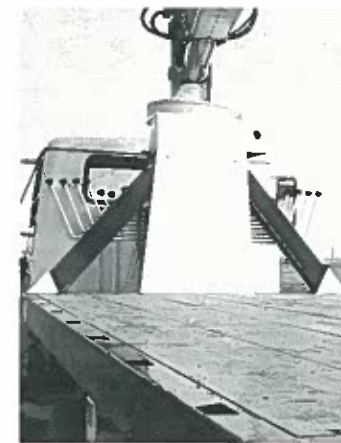

OTHER MANUFACTURERS' FIXED-ANGLE OUTRIGGERS

- OUTRIGGERS UNEQUALLY SPACED FROM CRANE CENTER LINE
- OUTRIGGER SPAN AT GROUND LEVEL LESS THAN FULLY EXTENDED
- CRANE WILL NOT BE EQUALLY STABLE ON BOTH SIDES

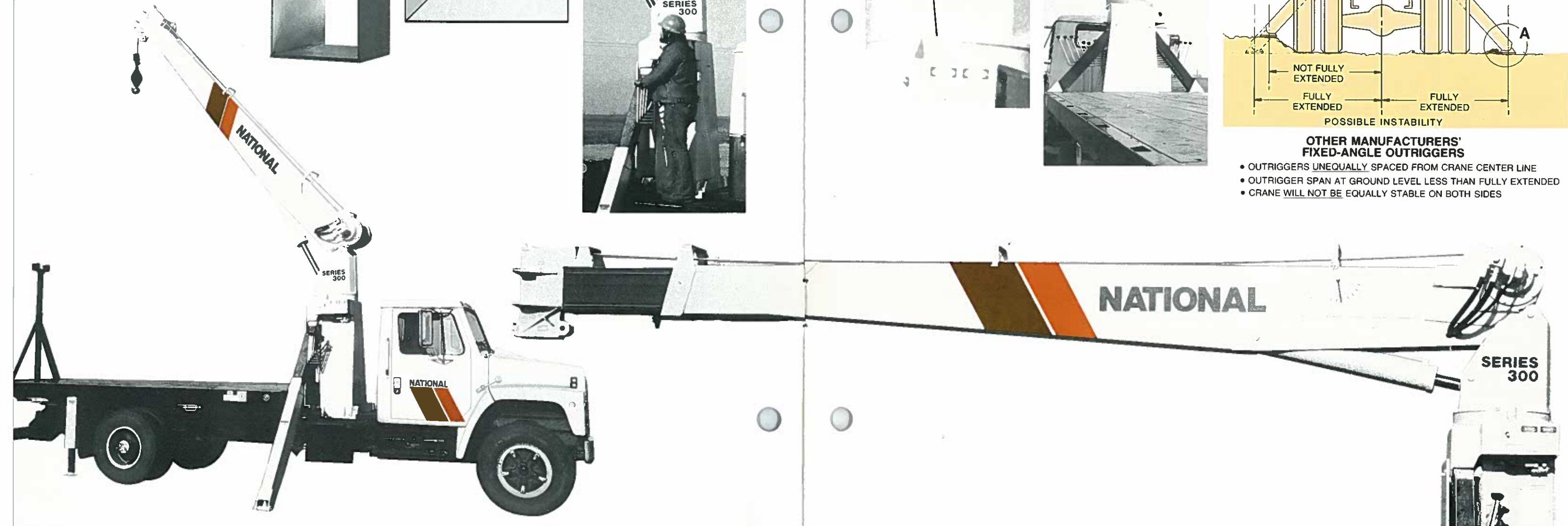

NATIONAL SERIES 300 BOOMS AND JIBS

Reach to 62 ft. available.

The versatile Series 300 is available with standard fixed boom, three-section telescoping boom or our 15-foot side stowing jib for extra reach.

This strong, easy to use jib folds and pins easily along the side of the main boom, not underneath like many other cranes. That makes rigging and stowing the jib a simple one-operator job.

Your National dealer can help you pick the reach and working height that will give you the greatest versatility and working capability.

Boom and Jib Combinations.

Model 316 Basic unit with 16 ft. fixed boom:

TELESCOPING BOOM

Model 337 16 to 37 ft. 3-Section

JIB

15 ft. straight

The chart on this page shows the reach and capacities of our 337 crane with 15-ft. jib. For more detailed information, consult your National dealer.

DO NOT OPERATE WITHIN 10 FEET OF LIVE POWER LINES.

1. Load ratings shown on this chart are maximum allowable loads with the outriggers properly extended on a firm level surface and the crane leveled and mounted on a factory-recommended truck.
2. Always level the crane with the level indicator located on the crane frame.
3. The operator must reduce loads to allow for factors such

- as wind, ground conditions, operating speeds and the effect of freely suspended loads.
4. Overloading this crane may cause structural collapse or instability.
5. Weights of any accessories attached to the boom or loadline must be deducted from the load chart capacities.
6. Do not exceed jib capacities at any reduced boom length.

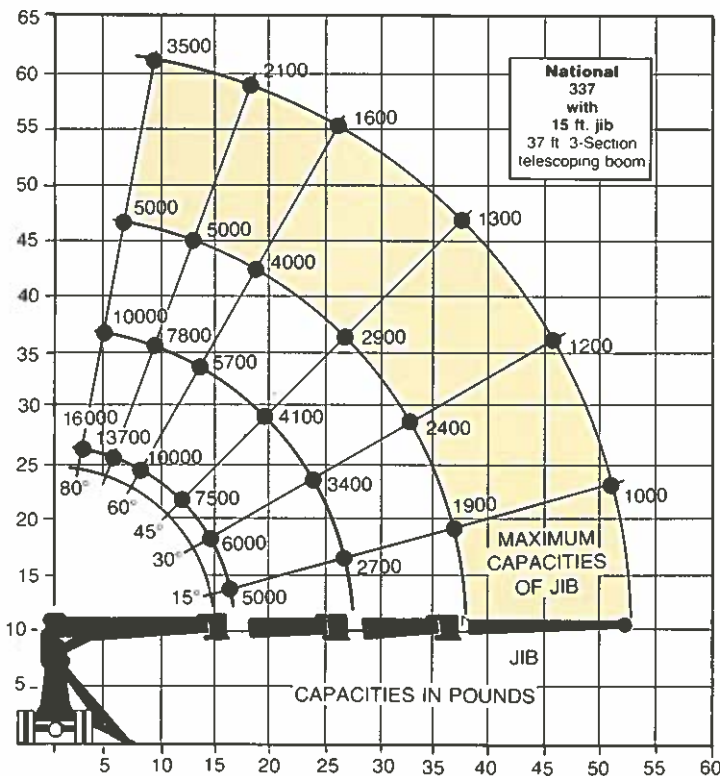

WINCH SELECTION

WINCH	MOTOR SELECTION	BARE DRUM	1 PART LIFT SPEED LBS. F.P.M.	2 PART LIFT SPEED LBS. F.P.M.	3 PART LIFT SPEED LBS. F.P.M.	4 PART LIFT SPEED LBS. F.P.M.
TULSA	—B—	4100 LBS.	3000 110	5800 55	8600 35	11500 28
MODEL 6	C-STD.	5800 LBS.	4500 80	8900 40	13000 27	17200 20
TP-1	25 M 42	8470 LBS.	6440 110	12340 55	18200 35	24000 28

NATIONAL SERIES 300 TRUCK SPECIFICATIONS

Minimum Truck Requirements

9,000 lbs. GAWR Front
17,500 lbs. GAWR Rear
26,500 GVWR
120 in. Cab to Axle
186 in. Wheelbase
Conventional Cab
Power Steering
Increased Cooling

GAWR means Gross Axle Weight Rating and is dependent on all components of the vehicle, such as axles, tires, springs, frame, etc., meeting manufacturer's recommendations. Always specify GAWR

when ordering trucks. The rear GAWR and truck GVWR are dependent on the type of mounting and configuration desired. Please consult your dealer.

Care must be taken in truck selection.

Front and/or rear stabilizers require a minimum 15 in.³ section modulus or frame must be capable of being reinforced to 15 in.³. (Normally a tapered front frame cannot be reinforced

to the required strength.) A factory furnished sub-base provides the 25 in.³ (50,000 PSI/MATERIAL MINIMUM) section modulus frame strength required for standard crane mounting.

Minimum axle requirements may increase with use of diesel engines, longer wheel base, or service bodies. Contact factory for further information.

Mounting Configurations

The versatility of the Series 300 can be enhanced by its mounting. The following are brief descriptions of our standard mounting configurations and their advantages.

Configuration 1:

This is the least expensive mounting method in many cases. If the truck is purchased above minimum specifications such as with a diesel engine or a tandem axle, counter-weight

is often not required. This mount requires the least weight for stability; thus, you can haul larger payloads on your truck.

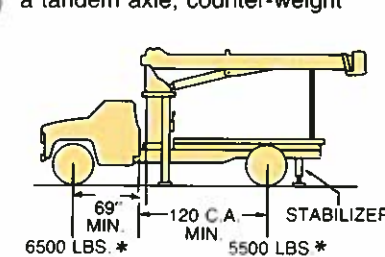

Requires 9,000 GAWRF, 17,500 GAWRR, 26,500 GVWR, rear stabilizers and bed with counterweight. Full capacity work area is rear 180° of ve-

hicle from outrigger to outrigger. Tandem axle trucks may be used for hauling larger payloads.

Configuration 2:

This mount requires front stabilizers and additional counterweight in the underside of the bed for full capacity 360° around

the truck. The front stabilizers give the machine a solid base, helping the operator control his loads precisely.

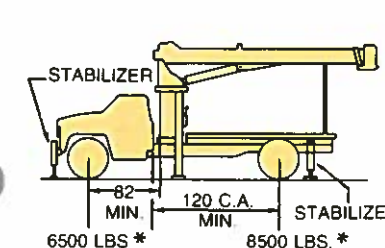

Requires 9,000 pound GAWRF, 18,500 GAWRR, 26,500 GVWR front and rear stabilizers, and usually requires

a reinforced bed with counterweight. Tandem axle trucks may be used for hauling larger payloads.

Configuration 3:

This mount allows 360° stability at full capacity without the use of front stabilizers. It requires additional weight at the rear of the truck to reduce loading on the front axle when lifting around the front. Since the front tires are used as a stabilizing

base, this is recommended only for the operator who occasionally lifts loads over the front of the vehicle. If loads are to be continually lifted around the front of the vehicle, front stabilizers are recommended to give this mount a firm base.

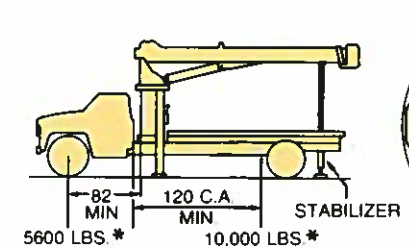

Requires 9,000 FAWR, 18,500 RAWR, 26,500 GVWR, rear stabilizers, and reinforced

bed with counterweight in the underside. Full capacity work area is 360° around the truck.

Rear Mounting

Rear mounting must include reinforced bed and tandem axle. For further details contact our factory.

*Actual axle scale weights prior to installation of crane.

NATIONAL SERIES 300 ACCESSORIES

Every Series 300 is more than just a crane. It's part of the most complete lifting system available.

The National Lifting System lets your 300 do more than just lift or handle materials. It lets you turn one truck-mounted crane into a whole fleet of specialized vehicles. At a fraction of the cost.

Because it can do so many jobs from start to finish, you save time, money and manpower on almost every job you do. You'll find you can do more jobs, faster, with less equipment. And that's money in your pocket.

Every Series 300 crane is built to work with our accessory line. And every accessory we make is designed to work specifically with Series 300 cranes. That means attachment is quick and easy. Once the proper controls are installed, you're ready to work.

National's accessories are designed and manufactured to the same excellent standards as our cranes. This provides you with years of low maintenance, high-productivity service.

Get the most from your National 300...make it more than just a crane with low-cost, hardworking accessories from the National Lifting System.

Remote Control

The latest edition of our one-hand remote control (patent pending). Ideal for use where precise control and total load visibility are required.

Fine metering and instant response mean operators can position loads, baskets and personnel platforms easily.

Now more reliable than ever with solid state circuitry and fewer parts than previous system. Other improvements include higher operating speeds and modular design.

Available in two models: R4 with tilt, turn telescope and winch functions, and R3 with tilt, turn and telescope only. R3 should be used to control cranes from basket or platform, using optional extension cables.

A priority control valve, operated by a trigger on the remote control unit, regulates oil flow and gives you fingertip speed control over all crane functions.

National remote control is the lightweight, easy-to-use way to add extra versatility to your crane.

Model R3

Tilt, turn and telescope

Model R4

Tilt, turn, telescope and winch.



DO NOT OPERATE CRANE OR REMOTE CONTROL NEAR LIVE POWER LINES.

One Person Basket

Strong, lightweight fiberglass basket with 300 lbs. capacity puts personnel where you want them for tough maintenance and installation jobs. Optional dual basket bracket for 2 basket operation. Easy on-off. Safety belts included.

Model B1

Model B1-L

With lock

DO NOT OPERATE WITHIN 10 FEET OF LIVE POWER LINES



Two Person Basket

Extra capacity (500 lbs.) steel basket for even greater crane versatility. Swing mounted to self-level. Lever operated friction brake for stability and locking. Safety belts included.

Model BS-1

5 ft. yoke

Model BS-2

12 ft. yoke. Side Stow

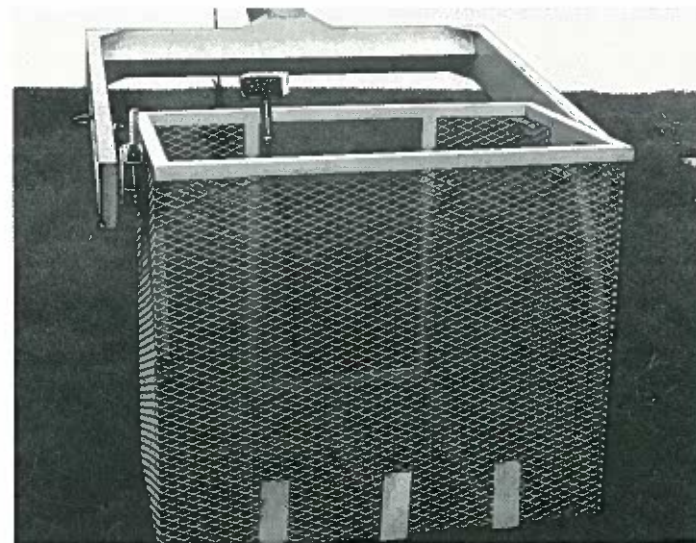

DO NOT OPERATE WITHIN 10 FEET OF LIVE POWER LINES

Personnel Platform

This extra strength 3 x 6 ft. steel platform will carry up to 1,000 lbs. and operate at working heights up to 52 ft. It is hydraulically self-leveling and protected by safety valves. Safety belts included. Fold down sides standard.

Model P

DO NOT OPERATE WITHIN 10 FEET OF LIVE POWER LINES

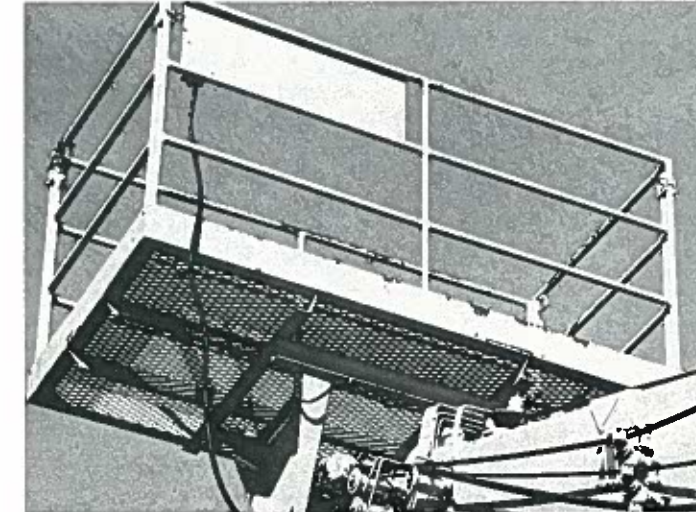

Outriggers and Stabilizers

We offer a complete range of cross-frame outriggers and front and rear stabilizers with hydraulic vertical and horizontal motion.

Outriggers

Extended Span 13' 6"

Retracted Span 7' 11"

Vertical Travel

Over-Frame 25"

Under-Frame 18"

Ground Penetration (38" Frame Height) 10"

Mounting Space

Crane/Outrigger 48"

Outrigger Only 18"

Mounting Behind cab, at rear of chassis or both

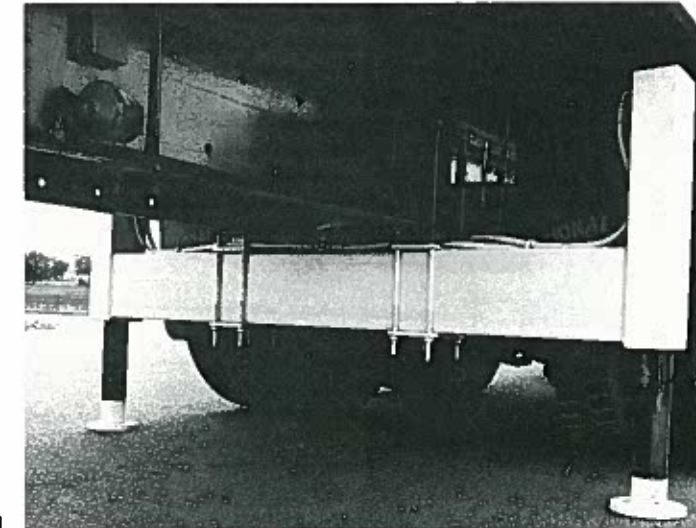

Stabilizers

Vertical Travel
Ground Penetration (38" Frame Height)
Operation
Span

Controls

Rear Mounted (Models RSH-15/18/25)

15", 18" or 25"

3", 6" or 13"

All-Hydraulic
6' (RSH-15)
8' (RSH-18/25)

Operated from either crane control station

Front Mounted (Model FSH-25 Fixed, Model FSHF-25 Folding)

25"

13"

All-Hydraulic
8'

Planetary Winch.

Optional extra capacity, heavy-duty winch with planetary gear drive for smoothness and strength.

Model TP-1

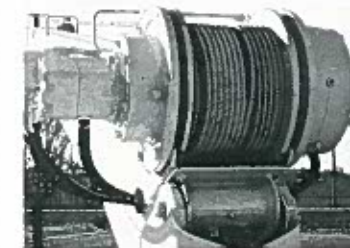

Crosswalk

Allows operator to walk between cab and crane for extra visibility when working loads on both sides. All steel construction with expanded steel mesh floor for better footing.

Model CW



NATIONAL SERIES 300 SPECIFICATIONS

General Construction:

Low-alloy, high-strength steel, including T-1, Tri-Ten, Stressproof, Hi-Yield, and other steels combined with special, low-hydrogen welding techniques wherever advantageous. Standard color: Painted National Ivory

Frame:

Box construction. Weld-on truck frame reinforcement forms base for crane frame. Bolt-on optional.

Turret:

Fabricated, rigid structure, well-braced for strength and stability.

Rotation:

375° noncontinuous. Rotation force 120,000 in./lbs. (360,000 in./lbs. breaking strength). Turret rotation by hydraulic orbit motor with worm gear driving a pinion with outboard bearing. The turret rotates on a ball bearing race.

Outriggers:

"A" frame box-type 13' 6" span (center of pad at ground level) moves out-and-down, will not bind when raising or lowering truck. Can be positioned to 8" below ground level when mounted on truck with a frame height of 38". Outrigger cylinders are equipped with butt-mounted, safety check valves.

Tilt:

Double-acting hydraulic cylinder raises and lowers boom; butt-mounted, safety holding valve prevents boom from falling in the event of hose failure.

Boom:

Boxed construction. Telescopes hydraulically in sequence under rated load on nylon plates impregnated with molybdenum disulfide which permits maximum loads to be extended at greater radii. Holding valves prevent retraction except under power.

Controls:

Dual side, stand-up, with operator platform and foot accelerator. Simultaneous operation of load-line and other operations standard.

Winch:

11,000 lbs. breaking strength. Hydraulic orbit motor provides "power down" load lowering. Choice of two capacities: 5,800 or 4,100 lb. pull on bare drum; only 25% less pull on final wrap with spool filled with 185 feet of 7/16 inch 8x19 IWRC, spin-resistant 8.97 ton breaking strength wire rope. Optional planetary winch available with 8,470 lb. bare drum single-line pull and 200 feet of 1/2" 11.6 ton breaking strength loadline.

Pump:

One Vickers, high-pressure, high-speed, balanced-vane, replaceable cartridge-type providing 25 gpm, maximum.

Cylinders:

Shaft packing: Polyurethane cup type. Shafts Hi-Yield, stress-relieved, chrome-plated. Piston sets: Cup and rider construction using stiff-back flex-lip, graphite cups. Cylinder barrels: Micro-honed tubing. Butt-mounted, safety check valves.

Valves:

Four-way, spring centered, spool-type with independent relief valves set at 2,350 psi (maximum 2,250 psi on winch system) to protect circuits against overload.

Hose:

All high-pressure hose is wire-braid reinforced, having a minimum safety factor of 4 to 1.

Operating Speeds:

Boom up or down: 22 sec.
Boom out: 16' to 37' in 39 sec.
Boom in: 37' to 16' in 39 sec.
Turn: 375° in 47 sec. When using remote control, crane function speeds reduced 50% to assure smooth operation. (Speeds above are maximum and assume no load and 1,800 rpm pump speed.)

Oil Tank Capacities:

30 gallon supply tank. Normally mounted under right-hand operator's platform. System has an approximate 50 gallon total capacity.

Filter:

10-micron, replaceable-cartridge, return-line filter.

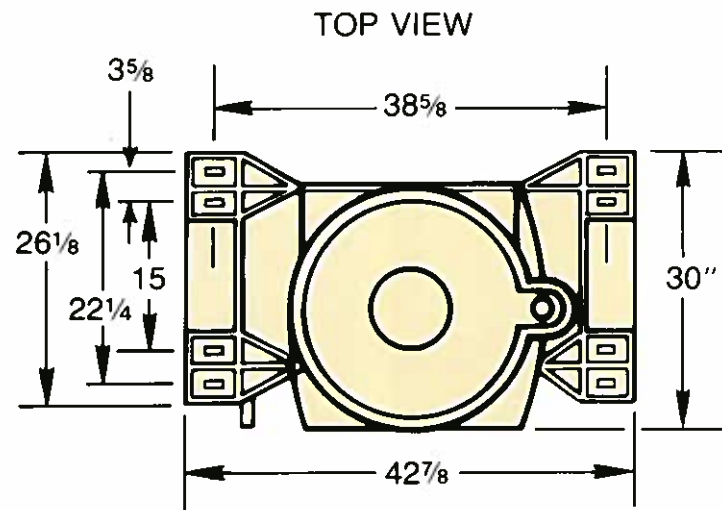

CENTER OF GRAVITY
337 40" WT 6800

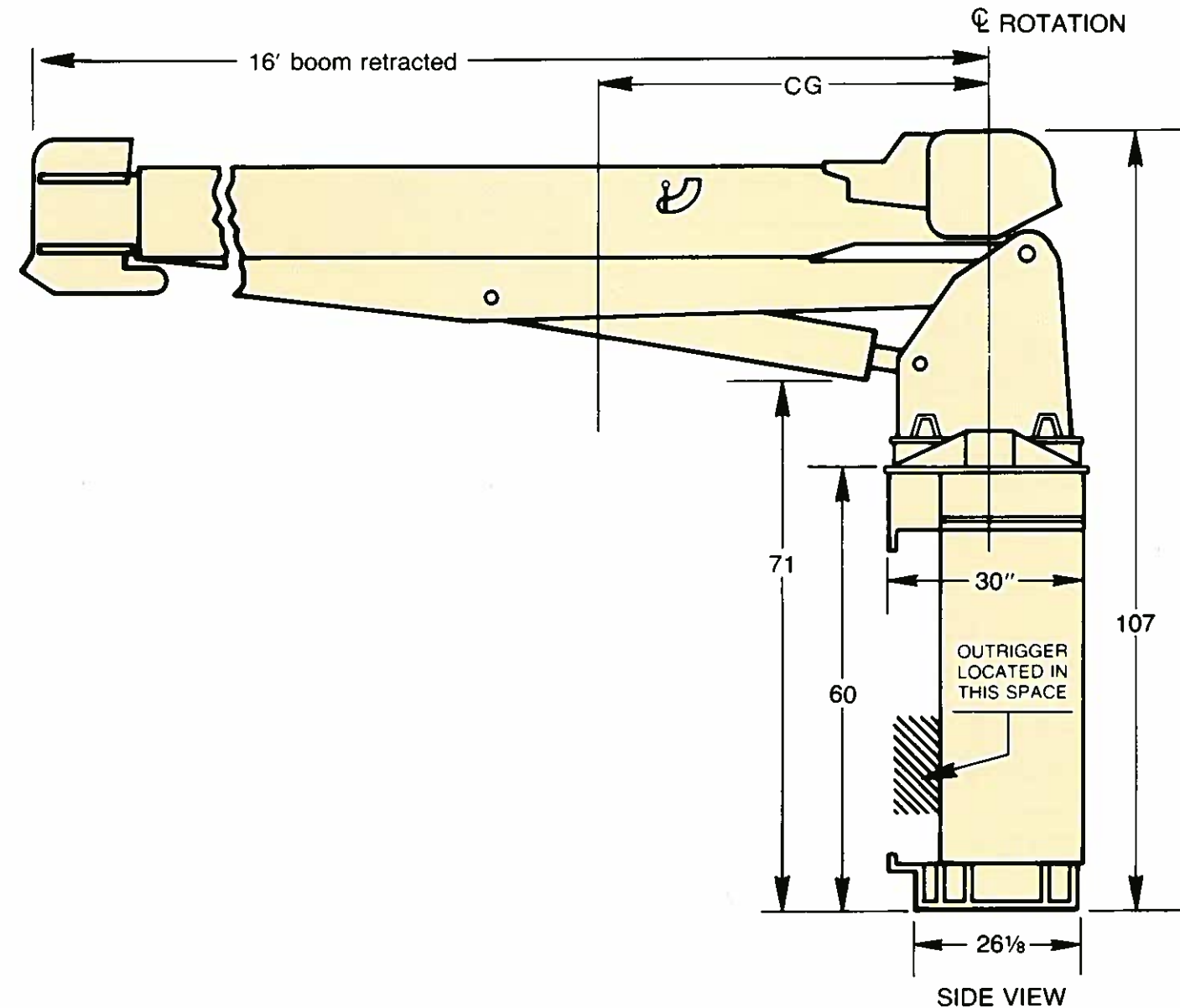
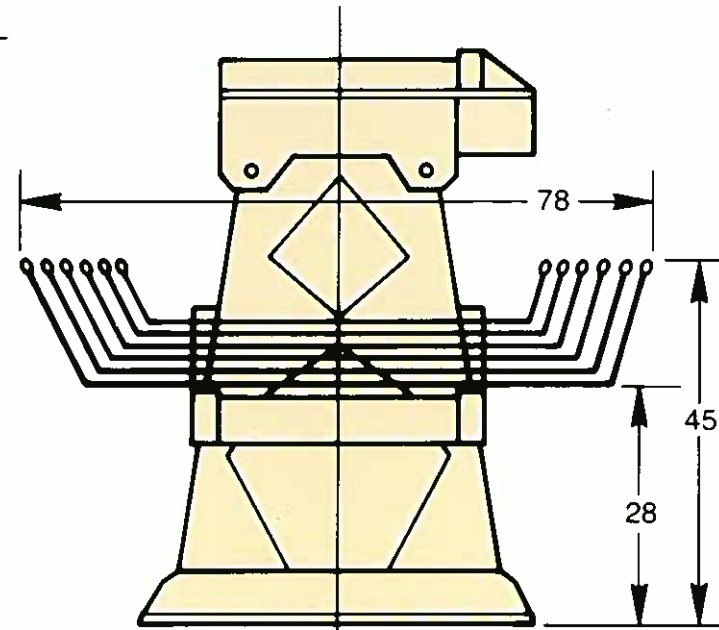

NATIONAL BOOM RESTS

Cranes are tough when they're in use, but they can be severely damaged during travel from job to job.

The only way to make sure your crane is protected from inadvertent damage is a strong, solid boom rest.

Boom Rests:

Add years to the life of your crane • Reduce stress on the crane frame • Protect rotation gear from transit damage • Remove stress from truck frame • Spread crane load more evenly • Reduce maintenance and downtime.

In addition, boom rests offer you a safe, positive way to immobilize your crane for transit.

We offer five heavy-duty boom rests for strong, sure protection of your crane. There's a quality National boom rest to fit your mounting configuration.

So protect your investment and add additional low maintenance years to the life of your crane with a boom rest tailored to your truck/crane combination. All factory-mounted cranes will be supplied with boom rests.

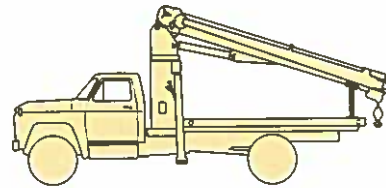

Low-profile rear bed mount for lower center of gravity

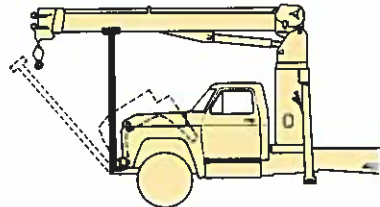

Front mount for trucks with tilting hoods

LARGER FRONT AXLE RATING REQUIRED.

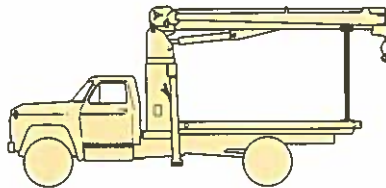

Horizontal rear bed mount for greater load space

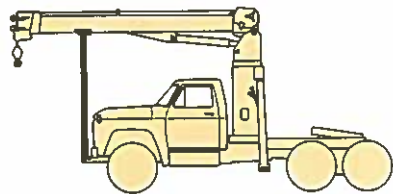

Tractor-trailer front mount

LARGER FRONT AXLE RATING REQUIRED.

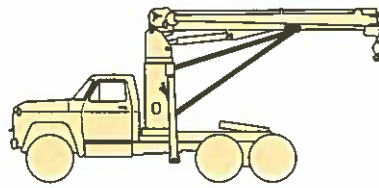

Tractor-trailer rear mount

NATIONAL WARRANTY/PARTS/SERVICE

The National Warranty

No product is better than its warranty. And no warranty is better than the company behind it.

We didn't get to be America's largest manufacturer of truck-mounted telescoping and articulating cranes by building less than the best. Or backing them with less than the most comprehensive warranty possible.

Our warranty covers your crane against defects in materials or workmanship for 6 full months from the date of shipment, subject to the conditions of the warranty.

When you select a National crane, you're getting more than just a crane. You're getting a nationwide dealer warranty service network, strong warranty protection and our special concern for every product we make.

Read our warranty. Then, don't settle for less. For complete information, write National Warranty Service, Waverly, NE 68462.

The National Parts System

Because even National cranes need parts, we back our dealers with an immediate, extensive parts supply. So your crane can get back on the job fast.

We have a highly trained parts and service staff to answer dealer service questions and expedite parts shipping. Most National parts will be on their way within 48 hours on request.

The National Service Center

Just west of Lincoln, Nebraska, we maintain one of the finest crane and truck service centers in the United States. Here, we do all our factory crane mounting.

Here, too, we research new and better products and fabricate custom cranes and installations.

The central location of our Lincoln Service Center makes it easy to return cranes for special modifications on extreme repairs. Most National dealers can perform all but the most unusual modifications or most serious repairs.

Should you need to return your crane to us for modification, warranty repair or other service, we will give it priority care and see it's returned as soon as possible.



NATIONAL SERIES 300 PROPOSAL

DATE: _____

Prepared for: _____

Submitted by: _____

(Firm Name)

(Address)

(City & State)

(Zip)

(Phone)

Signed: _____

DESCRIPTION:

1. Series _____ \$ _____
2. Boom _____
3. Jib _____
4. Winch Standard _____ Motor TPI _____
5. Rear Stabilizers 18" 25" Stroke _____
6. Front Stabilizers Std. Tilt _____
7. Line Block 2 Part 2 & 3 Part _____

ATTACHMENTS:

8. _____
9. _____
10. _____

MOUNTING:

11. Installment Std. Spec. _____
12. Frame re-enforcing Weld Bolt-Extra _____
13. Platform Body _____ Ft. Wood Steel _____
14. 1100 lbs. front bumper (if required) _____
15. Weight in bed _____ lbs. (if required) _____
16. Boom rest Parallel Low Other _____
17. Mount RSH _____
18. Mount FSH _____
19. Chassis _____
20. Rear Bumper _____
21. Freight _____

This quotation will remain firm for _____ days.

Accepted by: _____ \$ _____
(Name) TOTAL PRICE

(Firm Name) Date



NATIONAL CRANE

Subsidiary of Walter Kidde & Company, Inc.

KIDDE

General Offices

11200 North 148th Street/Waverly, NE 68462/402/786-2240

Service Center

701 N.W. 27th Street/Lincoln, NE 68528/402/474-2666

YOUR NATIONAL DEALER

National reserves the right to change designs, prices and specifications at any time without notice.