



**T 780-1**  
**80 US<sup>t</sup> Lifting Capacity**  
**Truck Crane**  
**Datasheet**  
**Imperial**



# T 780-1

**Features: T 780-1**

- ▶ 80 US<sup>t</sup> maximum lifting capacity
- ▶ 126 ft maximum boom length
- ▶ 133 ft maximum tip height
- ▶ Engine configurations up to 500 hp
- ▶ Automatic and manual transmission options
- ▶ Air-ride suspension
- ▶ Travel speeds up to 65 mph

**WORKS FOR YOU.™**

## Key

.....	3
-------	---

## Dimensions

Crane dimensions .....	4, 5, 6
Range diagram .....	7
Crane weights .....	8, 9

## Load charts

### 15,000 lb counterweight

Main boom, outriggers fully extended (100%), 360° .....	9
Main boom, outriggers fully extended (100%), over rear .....	9
Main boom, 33 ft offsettable jib, 360° .....	10
Main boom, 57 ft offsettable jib, 360° .....	10
Main boom, on tires .....	10

### 11,000 lb counterweight

Main boom, outriggers fully extended (100%), 360° .....	11
Main boom, outriggers fully extended (100%), over rear .....	11
Main boom, 33 ft offsettable jib, 360° .....	12
Main boom, 57 ft offsettable jib, 360° .....	12
Main boom, on tires .....	12

### 7,000 lb counterweight





Main boom, outriggers fully extended (100%), 360° .....	13
Main boom, outriggers fully extended (100%), over rear .....	13
Main boom, 33 ft offsettable jib, 360° .....	14
Main boom, 57 ft offsettable jib, 360° .....	14
Main boom, on tires .....	14

### 5,000 lb counterweight

Main boom, outriggers fully extended (100%), 360° .....	15
Main boom, outriggers fully extended (100%), over rear .....	15
Main boom, on tires .....	16

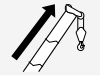
## Technical description

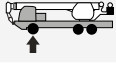
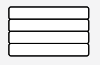
Boom .....	18
Hoist, rope, and hook .....	18, 19
Cab, controls, operator aids and load limiter / load indicator .....	19
Superstructure .....	20
Counterweight .....	20
Tires .....	20
Vehicle performance .....	20
Hydraulic system .....	20
Carrier, engine, and drive-line .....	21

	Boom length		General performance
	Tip height		Hoist speed
	Boom with extension		Rope – Standard / Optional
	Telescoping mode		Rope diameter
	Boom angle		Rope length
	Working radius		Max. line pull
	Max. boom length with extension		Electrical system
	Main boom with aux head		Tires
	Hook and block		Engine
	Hook and ball		Steering
	Gradeability		Speed
	Crane / Crane in standard configuration		Slewing / Allowable slewing range
	Gross vehicle weight		Slewing brake
	Weight on front axle		Main hoist
	Weight on rear axle		Auxiliary hoist
	Dolly		Cab
	Counterweight		Operator aids / Load limiter / Load indicator
	Outriggers		Transmission
	Swing/Rotation		Hydraulics
	Over rear		Heating / Air conditioning

# CRANE DIMENSIONS

T 780-1

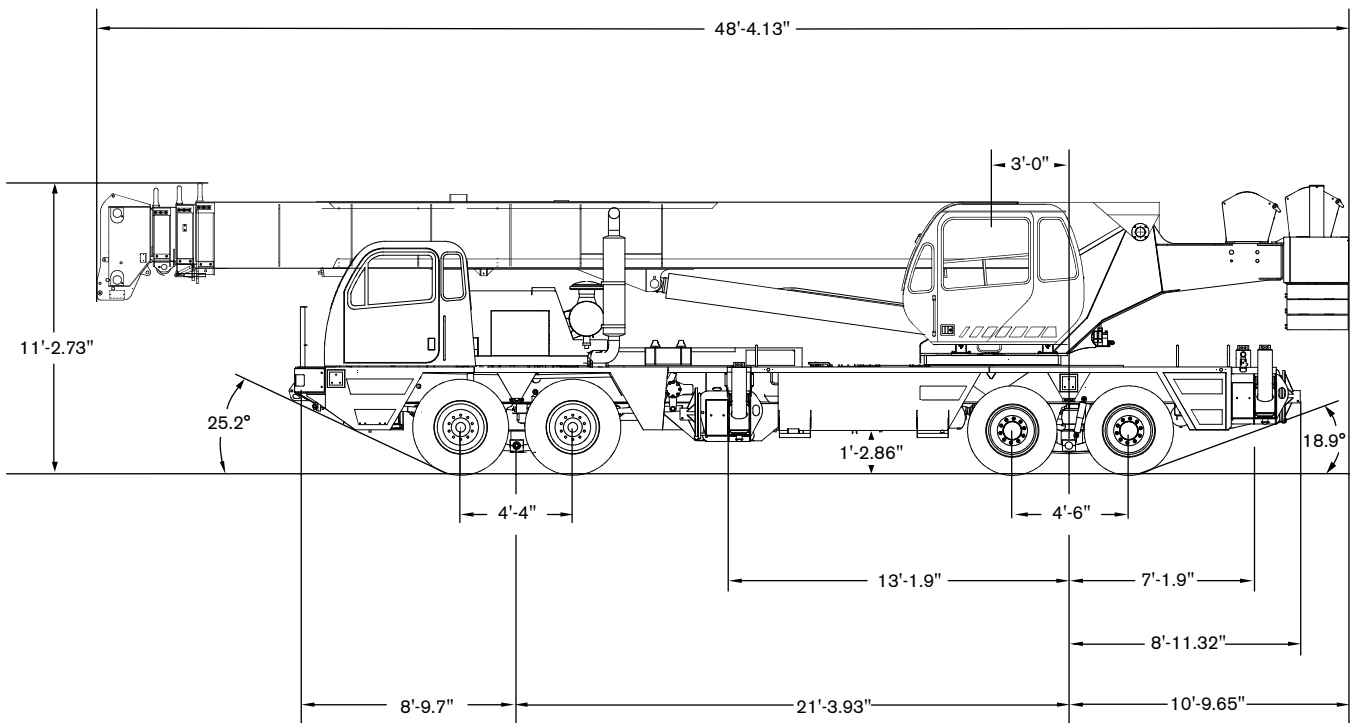

# CRANE DIMENSIONS

T 780-1

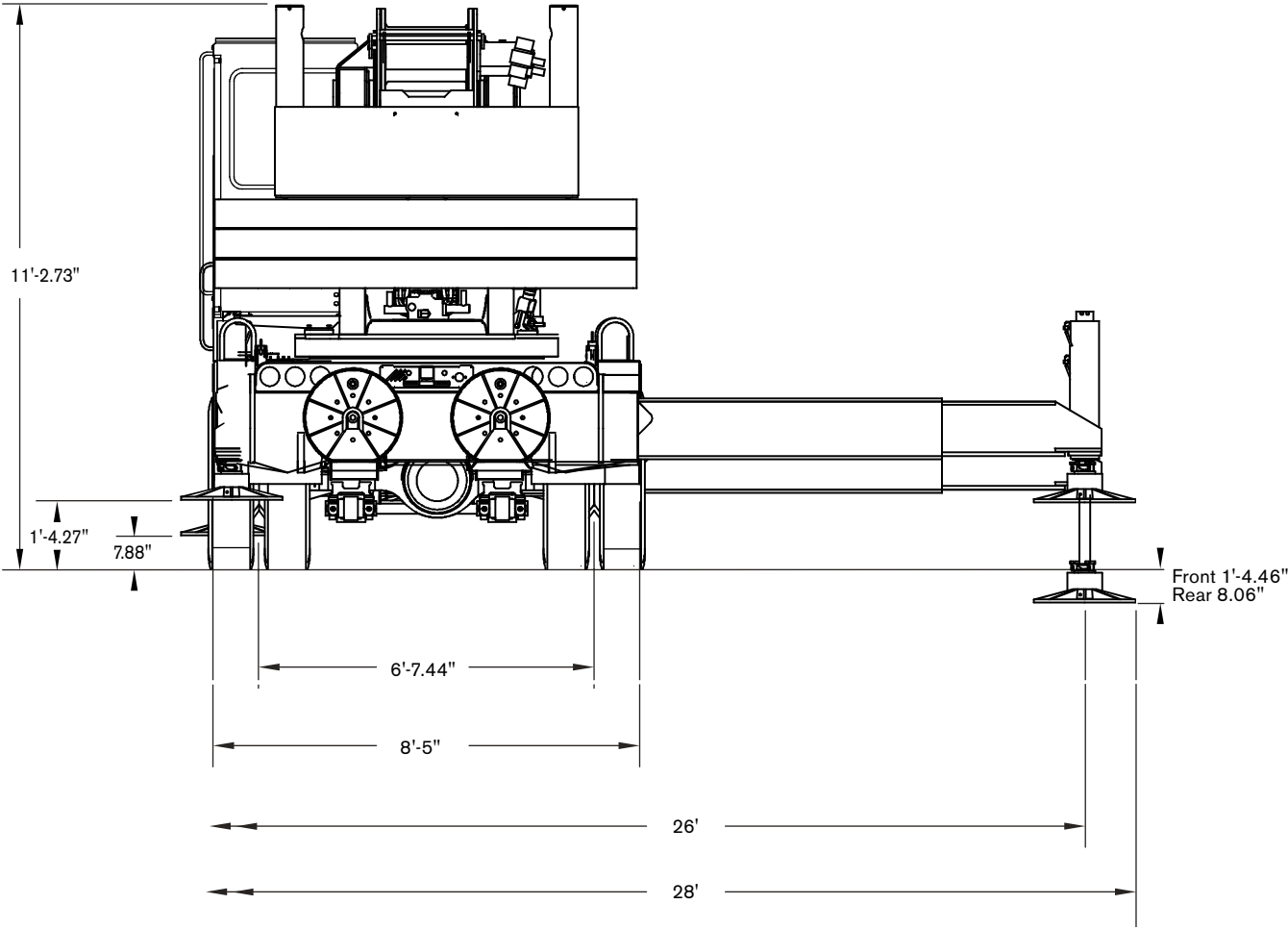

# CRANE DIMENSIONS

T 780-1

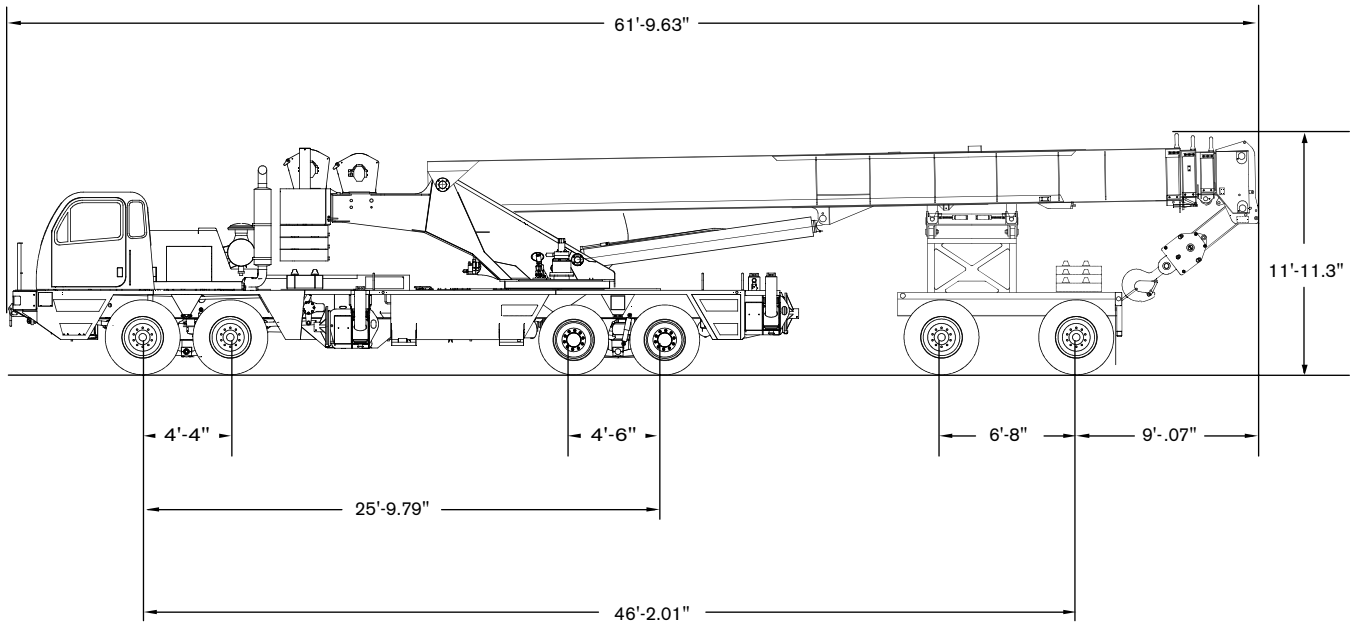

# RANGE DIAGRAM - MAIN BOOM

T 780-1

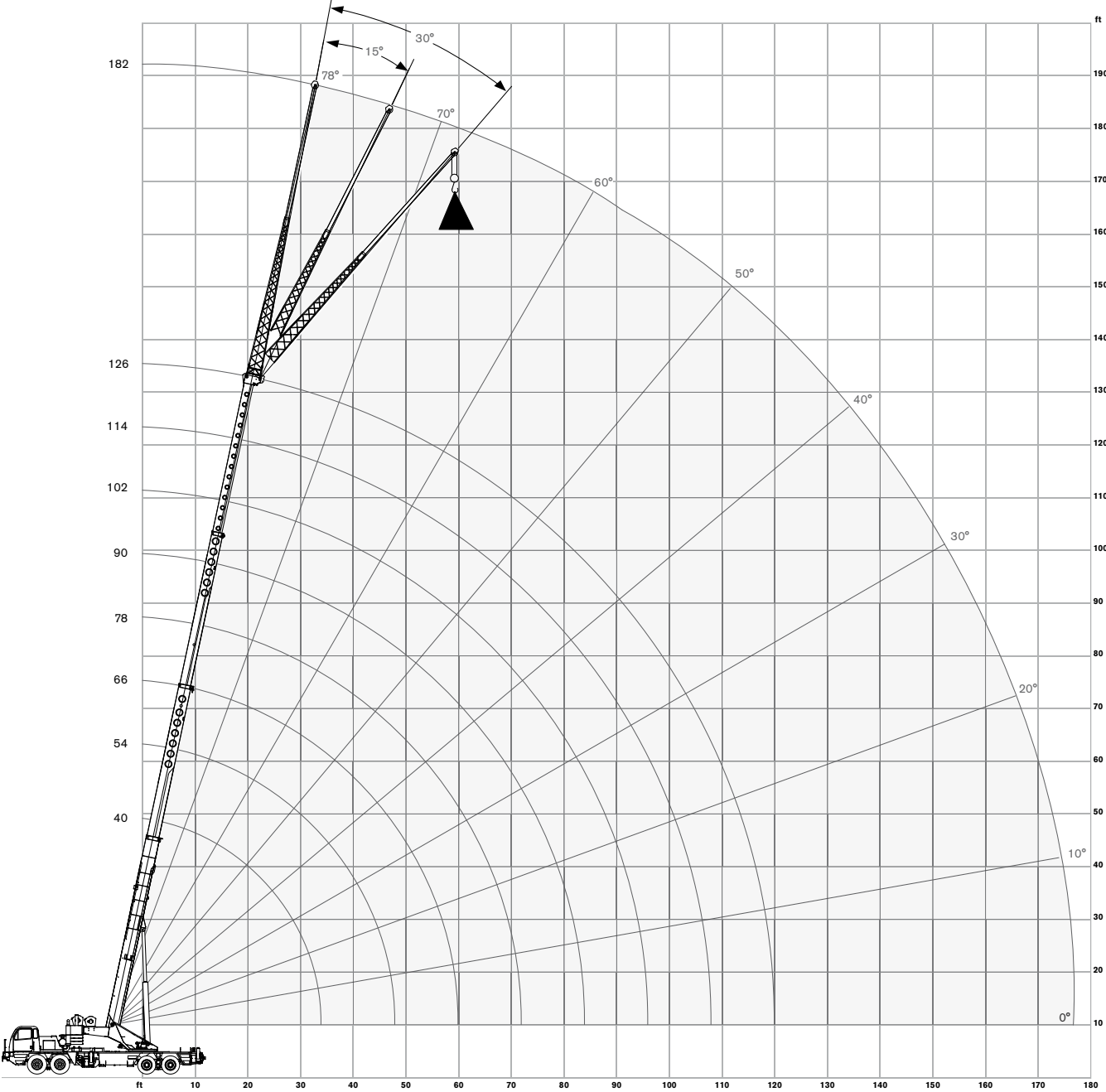

Outriggers Fully Extended (100%)



# SPECIFICATIONS

**T 780-1**

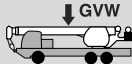
## Approximate Crane Weights

<b>Boom in front travel position</b>		 <b>Gross Vehicle</b>	 <b>Front max. 48,000 lb</b>	 <b>Rear max. 60,000 lb</b>
<b>Configuration:</b>	 <p>1/4 tank fuel 200 lb operator seated in cab Front tires: 445/65 20PR Rear tires: 315/80 22.5 20PR 126 ft boom/no jib 2,850 lb rear counterweight and 1,000 lb front bumper counterweight</p>	82,589	38,267	44,322
<b>Add/subtract options</b>				
	2,000 lb counterweight, removable on rear	+ 2,000	- 904	+ 2,904
	4,000 lb counterweight, removable on rear	+ 4,000	- 1,807	+ 5,807
	2,000 lb counterweight, removable on carrier deck	+ 2,000	+ 1,485	+ 515
	4,000 lb counterweight, removable on carrier deck	+ 4,000	+ 2,969	+ 1,031
	Full tank of fuel	+ 545	+ 244	+ 301
	Auxiliary hoist with drum roller and 600 ft of 16 x 9 class wire rope	+ 84	- 18	+ 102
	Spin resistant wire rope – main hoist	+ 96	- 31	+ 127
	Spin resistant wire rope – auxiliary hoist	+ 96	- 42	+ 138
	Electric remote control	+ 200	+ 100	+ 100
	32 ft swing-on jib	+ 1,270	+ 1,393	- 123
	32 ft to 57 ft extendable swing-on jib	+ 2,170	+ 2,262	- 92
	Auxiliary boom head	+ 125	+ 227	- 102
	80 USt hook block on bumper 5 sheave, quick reeving	+ 1,608	+ 2,569	- 961
	12 USt hook block on bumper	+ 419	+ 669	- 250



# SPECIFICATIONS

**T 780-1**

## Approximate Crane Weights

<b>Dolly and boom over rear</b>		 Gross Vehicle	 Front max. 48,000 lb	 Rear max. 60,000 lb	 Dolly
<b>Configuration:</b>	1/4 tank fuel 200 lb operator seated in cab Front tires: 445/65 20PR Rear tires: 315/80 22.5 20PR 126 ft boom/no jib 2,850 lb rear counterweight	87,075	29,162	37,299	20,614
<b>Add/subtract options</b>					
	2,000 lb counterweight, removable on rear	+ 2,000	+ 1,485	+ 515	+ 0
	4,000 lb counterweight, removable on rear	+ 4,000	+ 2,970	+ 1,030	+ 0
	2,000 lb counterweight, removable on carrier deck	+ 2,000	+ 1,485	+ 515	+ 0
	4,000 lb counterweight, removable on carrier deck	+ 4,000	+ 2,970	+ 1,030	+ 0
	4,000 lb counterweight, removable on dolly	+ 4,000	+ 0	+ 0	+ 4,000
	Full tank of fuel	+ 545	+ 244	+ 301	+ 0
	Auxiliary hoist with drum roller and 600 ft of 16 x 9 class wire rope	+ 84	+ 43	+ 41	+ 0
	Spin resistant wire rope – main hoist	+ 96	+ 59	+ 37	+ 0
	Spin resistant wire rope – auxiliary hoist	+ 96	+ 70	+ 26	+ 0
	Electric remote control	+ 200	+ 100	+ 100	+ 0
	32 ft swing-on jib	+ 1,270	+ 13	+ 18	+ 1,239
	32 ft to 57 ft extendable swing-on jib	+ 2,170	+ 62	+ 86	+ 2,022
	Auxiliary boom head	+ 125	- 43	- 60	+ 228
	80 USt hook block on bumper 5 sheave, quick reeving	+ 1,608	- 27	- 37	+ 1,672
	12 USt hook block on bumper	+ 419	- 7	- 10	+ 436

# LOAD CHART - MAIN BOOM

**T 780-1**

## Outriggers Fully Extended (100%)

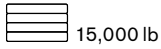

15,000 lb



100%



360°



40-126 ft

Standard ASME  
B30.5

ft	Boom Length (ft)								ft
	40	54	66	78	90	102	114	126	
10	160,000	102,500							10
12	125,600	102,500							12
15	108,900	100,500	80,600						15
20	83,800	84,800	71,900	62,200	56,200				20
25	65,500	66,500	64,800	55,700	48,000	41,900			25
30	52,200	53,600	54,000	49,700	41,700	36,400	31,500		30
35		40,900	41,500	41,700	36,600	32,100	29,500	24,700	35
40		32,500	33,100	33,400	32,900	28,600	26,200	24,600	40
45		26,400	27,100	27,400	27,600	25,700	23,500	22,100	45
50		19,000	22,500	22,900	23,100	23,300	21,400	20,000	50
55			19,000	19,400	19,700	19,800	19,500	18,200	55
60				16,600	16,800	17,000	17,100	16,600	60
65				14,200	14,500	14,700	14,800	14,900	65
70					12,600	12,800	12,900	13,000	70
75					11,000	11,100	11,300	11,400	75
80					9,500	9,800	9,900	10,000	80
85						8,500	8,700	8,800	85
90						7,500	7,700	7,700	90
95						6,500	6,700	6,800	95
100							5,800	6,000	100
105							5,000	5,200	105
110								4,500	110
115								3,900	115

## Outriggers Fully Extended (100%)

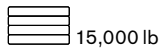

15,000 lb

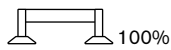

100%



Over Rear



40-126 ft

Standard ASME  
B30.5

ft	Boom Length (ft)								ft
	40	54	66	78	90	102	114	126	
10	160,000	102,500							10
12	125,600	102,500							12
15	108,900	100,500	80,600						15
20	84,500	85,300	71,900	62,200	56,200				20
25	65,500	66,500	64,800	55,700	48,000	41,900			25
30	52,200	53,600	54,000	49,700	41,700	36,400	31,500		30
35		40,900	41,500	41,700	36,600	32,100	29,500	24,700	35
40		32,500	33,100	33,400	32,900	28,600	26,200	24,600	40
45		26,400	27,100	27,400	27,600	25,700	23,500	22,100	45
50			22,500	22,900	23,100	23,300	21,400	20,000	50
55			19,000	19,400	19,700	19,800	19,500	18,200	55
60				16,600	16,800	17,000	17,100	16,600	60
65				14,200	14,500	14,700	14,800	14,900	65
70				12,300	12,600	12,800	12,900	13,000	70
75					11,000	11,100	11,300	11,400	75
80					9,500	9,800	9,900	10,000	80
85						8,500	8,700	8,800	85
90						7,500	7,700	7,700	90
95						6,500	6,700	6,800	95
100							5,800	6,000	100
105							5,100	5,200	105
110								4,600	110
115								3,900	115

## Notes to lifting capacity

Lifting capacities do not exceed 85% of tipping load. Weight of hook blocks and slings is part of the load, and is to be deducted from the capacity ratings. Consult operation manual for further details.

Note: Data published herein is intended as a guide only and shall not be construed to warrant applicability for lifting purposes. Crane operation is subject to the computer charts and operation manual both supplied with the crane.





# LOAD CHART - MAIN BOOM

**T 780-1**

## With Offset Jibs

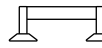
 15,000 lb

 100%

 360°

Standard ASME  
B30.5

33 ft Offsettable Jib					
0° Offset		15° Offset		30° Offset	
ft	lb	ft	lb	ft	lb
40	12,500	51	8,500	56	6,400
47	12,000	56	8,100	61	6,200
53	11,500	62	7,800	67	6,100
59	10,900	67	7,500	72	5,900
68	9,900	75	7,100	79	5,900
76	9,200	82	6,700	86	5,600
83	8,900	89	6,400	93	5,400
90	7,900	96	6,200	99	5,300
99	6,800	104	5,900	107	5,200
106	5,700	111	5,300	114	5,100
113	4,700	118	4,500	121	4,500
120	3,900	125	3,800	126	3,700
127	3,100	132	3,100	132	3,000
135	2,400	139	2,400	138	2,400
143	1,800	145	1,700		
150	1,300	150	1,300		
152	1,100				

57 ft Offsettable Jib					
0° Offset		15° Offset		30° Offset	
ft	lb	ft	lb	ft	lb
49	6,500	65	4,500	76	3,300
56	6,400	71	4,300	81	3,200
63	6,200	77	4,100	87	3,100
70	6,000	83	3,900	92	3,000
80	5,400	92	3,700	100	2,900
89	4,900	100	3,500	107	2,800
98	4,500	108	3,300	114	2,700
106	4,200	115	3,100	121	2,600
116	3,800	124	2,900	129	2,500
126	3,500	132	2,800	136	2,500
134	3,300	140	2,700	143	2,400
142	3,100	147	2,600	149	2,400
150	2,500	154	2,300	156	2,300
159	1,900	162	1,800	162	1,800
167	1,400	169	1,400		
173	1,000	174	1,000		
177	800				

## On Tires

 15,000 lb

 On tires

 Over Rear

Standard ASME  
B30.5

Boom		Travel Speed: Boom straight over rear		
ft	ft	0 mph	Creep	2.5 mph
		lb	lb	lb
10	40	53,700	38,700	31,200
12	40	49,300	35,300	28,400
15	40	43,800	31,100	24,700
20	40	33,000	25,500	19,900
25	54	23,400	21,100	16,300
30	54	17,700	17,700	13,300
35	54	13,700	13,700	10,900
40	66	11,100	11,100	9,300
45	66	8,900	8,900	7,900
50	66	7,200	7,200	6,700
55	78	5,800	5,800	5,700
60	78	4,600	4,600	4,600
65	78	3,700	3,700	3,700
70	90	3,000	3,000	3,000
75	90	2,400	2,400	2,400
80	90	1,800	1,800	1,800

## Notes to lifting capacity

Lifting capacities do not exceed 85% of tipping load, (75% of tipping load on tires). Weight of hook blocks and slings is part of the load, and is to be deducted from the capacity ratings. Consult operation manual for further details.

Note: Data published herein is intended as a guide only and shall not be construed to warrant applicability for lifting purposes. Crane operation is subject to the computer charts and operation manual both supplied with the crane.

# LOAD CHART - MAIN BOOM

**T 780-1**

## Outriggers Fully Extended (100%)

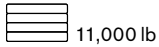

11,000 lb



100%



360°



40-126 ft

Standard ASME  
B30.5

ft	Boom Length (ft)								ft
	40	54	66	78	90	102	114	126	
10	160,000	102,500							10
12	125,600	102,500							12
15	108,900	100,500	80,600						15
20	82,000	83,100	71,900	62,200	56,200				20
25	63,400	64,500	64,800	55,700	48,000	41,900			25
30	49,000	50,400	50,800	49,700	41,700	36,400	31,500		30
35		38,400	38,900	39,200	36,600	32,100	29,500	24,700	35
40		30,300	30,900	31,200	31,400	28,600	26,200	24,600	40
45		24,600	25,200	25,600	25,700	25,700	23,500	22,100	45
50			20,900	21,300	21,500	21,600	21,400	20,000	50
55			17,500	17,900	18,100	18,200	18,300	18,200	55
60				15,100	15,400	15,500	15,600	15,700	60
65				12,800	13,100	13,300	13,400	13,400	65
70				11,000	11,300	11,400	11,500	11,600	70
75					9,700	9,900	10,000	10,100	75
80					8,300	8,500	8,700	8,800	80
85						7,400	7,500	7,600	85
90						6,400	6,500	6,600	90
95						5,500	5,600	5,800	95
100							4,900	5,000	100
105							4,100	4,300	105
110								3,600	110
115								3,100	115

## Outriggers Fully Extended (100%)

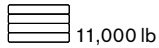

11,000 lb

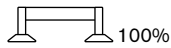

100%



Over Rear



40-126 ft

Standard ASME  
B30.5

ft	Boom Length (ft)								ft
	40	54	66	78	90	102	114	126	
10	160,000	102,500							10
12	125,600	102,500							12
15	108,900	100,500	80,600						15
20	82,000	83,100	71,900	62,200	56,200				20
25	63,400	64,500	64,800	55,700	48,000	41,900			25
30	49,000	50,400	50,800	49,700	41,700	36,400	31,500		30
35		38,400	38,900	39,200	36,600	32,100	29,500	24,700	35
40		30,300	30,900	31,200	31,400	28,600	26,200	24,600	40
45		24,600	25,200	25,600	25,700	25,700	23,500	22,100	45
50			20,900	21,300	21,500	21,600	21,400	20,000	50
55			17,500	17,900	18,200	18,300	18,400	18,200	55
60				15,200	15,500	15,700	15,800	15,800	60
65				13,000	13,300	13,500	13,600	13,700	65
70				11,200	11,500	11,700	11,800	11,900	70
75					9,900	10,100	10,200	10,300	75
80					8,600	8,800	8,900	9,000	80
85						7,600	7,800	7,900	85
90						6,600	6,700	6,900	90
95						5,700	5,900	6,000	95
100							5,100	5,200	100
105							4,300	4,500	105
110								3,800	110
115								3,200	115

## Notes to lifting capacity

Lifting capacities do not exceed 85% of tipping load. Weight of hook blocks and slings is part of the load, and is to be deducted from the capacity ratings. Consult operation manual for further details.

Note: Data published herein is intended as a guide only and shall not be construed to warrant applicability for lifting purposes. Crane operation is subject to the computer charts and operation manual both supplied with the crane.





# LOAD CHART - MAIN BOOM

**T 780-1**

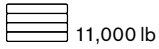
## On Tires



Standard ASME  
B30.5

Boom		Travel Speed: Boom straight over rear		
 10 ft	 40 ft	0 mph lb	Creep lb	2.5 mph lb
10	40	56,000	41,000	33,500
12	40	51,500	37,500	30,500
15	40	45,500	33,000	26,700
20	40	29,500	27,200	21,700
25	54	21,100	21,100	17,800
30	54	16,000	16,000	14,700
35	54	12,600	12,600	12,100
40	66	9,700	9,700	9,700
45	66	7,500	7,500	7,500
50	66	5,900	5,900	5,900
55	78	4,800	4,800	4,800
60	78	4,000	4,000	4,000
65	78	3,300	3,300	3,300
70	90	2,800	2,800	2,800
75	90	2,100	2,100	2,100

## Notes to lifting capacity

Lifting capacities do not exceed 85% of tipping load, (75% of tipping load on tires). Weight of hook blocks and slings is part of the load, and is to be deducted from the capacity ratings. Consult operation manual for further details.

Note: Data published herein is intended as a guide only and shall not be construed to warrant applicability for lifting purposes. Crane operation is subject to the computer charts and operation manual both supplied with the crane.

# LOAD CHART - MAIN BOOM

**T 780-1**

## Outriggers Fully Extended (100%)



 7,000 lb

 100%

 360°

 40-126 ft

Standard ASME  
B30.5

	Boom Length (ft)								
	40	54	66	78	90	102	114	126	
ft	lb	lb	lb	lb	lb	lb	lb	lb	ft
10	149,300	102,500							10
12	125,600	102,500							12
15	106,300	100,500	80,600						15
20	79,600	80,600	71,900	62,200	56,200				20
25	61,500	62,500	63,100	55,700	48,000	41,900			25
30	44,600	46,000	46,400	46,700	41,700	36,400	31,500		30
35		34,900	35,400	35,600	35,800	32,100	29,500	24,700	35
40		27,400	28,000	28,300	28,500	28,600	26,200	24,600	40
45		22,000	22,700	23,000	23,000	23,200	23,400	22,100	45
50			18,700	19,100	19,300	19,400	19,500	19,600	50
55			15,500	15,900	16,100	16,300	16,300	16,400	55
60				13,200	13,500	13,900	13,700	13,800	60
65				11,100	11,400	11,900	11,600	11,700	65
70				9,300	9,600	10,200	9,900	10,000	70
75					8,100	8,700	8,400	8,500	75
80					6,900	7,500	7,200	7,300	80
85						6,400	6,100	6,200	85
90						5,500	5,200	5,300	90
95						4,600	4,400	4,500	95
100							3,600	3,700	100
105							2,900	3,100	105
110								2,500	110
115								2,000	115

## Outriggers Fully Extended (100%)



 7,000 lb

 100%

 Over Rear

 40-126 ft

Standard ASME  
B30.5

	Boom Length (ft)								
	40	54	66	78	90	102	114	126	
ft	lb	lb	lb	lb	lb	lb	lb	lb	ft
10	160,000	102,500							10
12	125,600	102,500							12
15	108,900	100,500	80,600						15
20	79,600	80,600	71,900	62,200	56,200				20
25	61,500	62,500	63,100	55,700	48,000	41,900			25
30	44,600	46,000	46,400	46,700	41,700	36,400	31,500		30
35		34,900	35,400	35,600	35,800	32,100	29,500	24,700	35
40		27,400	28,000	28,300	28,500	28,600	26,200	24,600	40
45		22,000	22,700	23,000	23,000	23,200	23,400	22,100	45
50			18,700	19,100	19,300	19,400	19,500	19,600	50
55			15,500	15,900	16,200	16,300	16,400	16,500	55
60				13,400	13,700	13,900	14,000	14,100	60
65				11,400	11,700	11,900	12,000	12,100	65
70				9,700	10,000	10,200	10,300	10,400	70
75					8,500	8,700	8,900	9,000	75
80					7,300	7,500	7,600	7,800	80
85						6,400	6,600	6,700	85
90						5,500	5,600	5,700	90
95						4,600	4,800	4,900	95
100							4,000	4,200	100
105							3,400	3,500	105
110								2,900	110
115								2,400	115

## Notes to lifting capacity

Lifting capacities do not exceed 85% of tipping load. Weight of hook blocks and slings is part of the load, and is to be deducted from the capacity ratings. Consult operation manual for further details.

Note: Data published herein is intended as a guide only and shall not be construed to warrant applicability for lifting purposes. Crane operation is subject to the computer charts and operation manual both supplied with the crane.



# LOAD CHART - MAIN BOOM

**T 780-1**

## With Offset Jibs

 7,000 lb

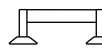
 100%

 360°

Standard ASME  
B30.5

33 ft Offsettable Jib					
0° Offset		15° Offset		30° Offset	
ft	lb	ft	lb	ft	lb
39	12,500	49	8,500	57	6,400
46	12,000	55	8,100	62	6,200
53	11,500	60	7,800	67	6,100
59	10,900	66	7,500	72	5,900
67	9,900	73	7,100	79	5,900
75	9,200	81	6,700	86	5,600
82	8,000	87	6,400	93	5,400
88	6,800	94	6,000	99	5,300
97	5,400	102	4,900	106	4,500
104	4,200	110	3,900	113	3,600
111	3,300	117	3,100	120	2,900
117	2,600	123	2,400	126	2,200
125	1,800	130	1,600	132	1,600
135	1,200	137	1,000	138	1,100

57 ft Offsettable Jib					
0° Offset		15° Offset		30° Offset	
ft	lb	ft	lb	ft	lb
49	6,500	66	4,500	75	3,300
57	6,400	72	4,300	81	3,200
64	6,200	78	4,100	86	3,100
71	6,000	84	3,900	92	3,000
81	5,400	92	3,700	99	2,900
90	4,900	100	3,500	107	2,800
98	4,500	108	3,300	114	2,700
106	4,200	115	3,100	120	2,600
116	3,800	124	2,900	128	2,500
124	3,200	132	2,800	136	2,500
132	2,400	140	2,200	143	2,200
139	1,800	146	1,700	149	1,700
147	1,200	154	1,200	155	1,200

## On Tires

 7,000 lb

 On tires

 Over Rear

Standard ASME  
B30.5

Boom		Travel Speed: Boom straight over rear		
ft	ft	0 mph	Creep	2.5 mph
		lb	lb	lb
10	40	56,000	41,000	33,500
12	40	51,500	37,500	30,500
15	40	45,500	33,000	26,700
20	40	29,500	27,200	21,700
25	54	21,100	21,100	17,800
30	54	16,000	16,000	14,700
35	54	12,600	12,600	12,100
40	66	9,700	9,700	9,700
45	66	7,500	7,500	7,500
50	66	5,900	5,900	5,900
55	78	4,800	4,800	4,800
60	78	4,000	4,000	4,000
65	78	3,300	3,300	3,300
70	90	2,800	2,800	2,800

## Notes to lifting capacity

Lifting capacities do not exceed 85% of tipping load, (75% of tipping load on tires). Weight of hook blocks and slings is part of the load, and is to be deducted from the capacity ratings. Consult operation manual for further details.

Note: Data published herein is intended as a guide only and shall not be construed to warrant applicability for lifting purposes. Crane operation is subject to the computer charts and operation manual both supplied with the crane.

# LOAD CHART - MAIN BOOM

**T 780-1**

## Outriggers Fully Extended (100%)

 5,000 lb

 100%

 360°

 40-126 ft

Standard ASME  
B30.5

ft	Boom Length (ft)								ft
	40	54	66	78	90	102	114	126	
10	148,200	102,500							10
12	125,600	102,500							12
15	108,900	100,500	80,600						15
20	82,000	83,100	71,900	62,200	56,200				20
25	63,400	64,500	64,800	55,700	48,000	41,900			25
30	49,000	50,400	50,800	49,700	41,700	36,400	31,500		30
35		38,400	38,900	39,200	36,600	32,100	29,500	24,700	35
40		30,300	30,900	31,200	31,400	28,600	26,200	24,600	40
45		24,600	25,200	25,600	25,700	25,700	23,500	22,100	45
50			20,900	21,300	21,500	21,600	21,400	20,000	50
55			17,500	17,900	18,100	18,200	18,300	18,200	55
60				15,100	15,400	15,500	15,600	15,700	60
65				12,800	13,100	13,300	13,400	13,400	65
70				11,000	11,300	11,400	11,500	11,600	70
75					9,700	9,900	10,000	10,100	75
80					8,300	8,500	8,700	8,800	80
85						7,400	7,500	7,600	85
90						6,400	6,500	6,600	90
95						5,500	5,600	5,800	95
100							4,900	5,000	100
105							4,100	4,300	105
110								3,600	110
115								3,100	115

## Outriggers Fully Extended (100%)

 5,000 lb

 100%

 Over Rear

 40-126 ft

Standard ASME  
B30.5

ft	Boom Length (ft)								ft
	40	54	66	78	90	102	114	126	
10	160,000	102,500							10
12	125,600	102,500							12
15	108,900	100,500	80,600						15
20	82,000	83,100	71,900	62,200	56,200				20
25	63,400	64,500	64,800	55,700	48,000	41,900			25
30	49,000	50,400	50,800	49,700	41,700	36,400	31,500		30
35		38,400	38,900	39,200	36,600	32,100	29,500	24,700	35
40		30,300	30,900	31,200	31,400	28,600	26,200	24,600	40
45		24,600	25,200	25,600	25,700	25,700	23,500	22,100	45
50			20,900	21,300	21,500	21,600	21,400	20,000	50
55			17,500	17,900	18,200	18,300	18,400	18,200	55
60				15,200	15,500	15,700	15,800	15,800	60
65				13,000	13,300	13,500	13,600	13,700	65
70				11,200	11,500	11,700	11,800	11,900	70
75					9,900	10,100	10,200	10,300	75
80					8,600	8,800	8,900	9,000	80
85						7,600	7,800	7,900	85
90						6,600	6,700	6,900	90
95						5,700	5,900	6,000	95
100							5,100	5,200	100
105							4,300	4,500	105
110								3,800	110
115								3,200	115

## Notes to lifting capacity

Lifting capacities do not exceed 85% of tipping load. Weight of hook blocks and slings is part of the load, and is to be deducted from the capacity ratings. Consult operation manual for further details.

Note: Data published herein is intended as a guide only and shall not be construed to warrant applicability for lifting purposes. Crane operation is subject to the computer charts and operation manual both supplied with the crane.





# LOAD CHART - MAIN BOOM

**T 780-1**

## On Tires

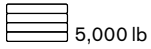

5,000 lb





On tires



Over Rear

Standard ASME  
B30.5











Boom		Travel Speed: Boom straight over rear		
 ft	 ft	0 mph lb	Creep lb	2.5 mph lb
10	40	55,600	40,600	33,200
12	40	49,100	37,200	30,200
15	40	40,000	32,700	26,400
20	40	27,500	26,900	21,400
25	54	18,200	18,200	17,500
30	54	12,400	12,400	12,400
35	54	9,900	9,900	9,900
40	66	7,700	7,700	7,700
45	66	5,600	5,600	5,600
50	66	4,700	4,700	4,700
55	78	3,600	3,600	3,600
60	78	2,700	2,700	2,700
65	78	1,800	1,800	1,800

## Notes to lifting capacity

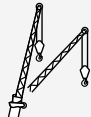
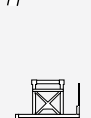



Lifting capacities do not exceed 85% of tipping load, (75% of tipping load on tires). Weight of hook blocks and slings is part of the load, and is to be deducted from the capacity ratings. Consult operation manual for further details.

Note: Data published herein is intended as a guide only and shall not be construed to warrant applicability for lifting purposes. Crane operation is subject to the computer charts and operation manual both supplied with the crane.

## Boom

Standard configuration:		
	Full power extension via foot pedal control	4 sections
	Minimum / Maximum	40 ft / 126 ft
	Maximum tip height	133 ft
	Boom elevation angle range (min. / max.)	-4° / 78°
Optional configuration:		
	32 ft swing-on jib, fixed length	
	Angular offsets	0°, 15°, 30°
	Maximum tip height with fixed jib	164 ft
	33–57 ft swing-on jib with 25 ft extension	
	Angular offsets	0°, 15°, 30°
	Maximum tip height with extended jib	189 ft
	Boom Dolly	
	5 or 6 metallic load sheaves	
	2 nylon Idler sheaves	
	Quick reeving design	
	Single nylon sheave	
	Installs only on main boom head, compatible with extendable and fixed swing-on jibs	
	Quick reeving with 5 metal sheaves	80 US t
	Quick reeving with 5 metal sheaves	60 US t
	Top swivel ball with hook and latch	12 US t

## Hoist, Rope and Hook

Standard configuration:		
	Two speed ratios	
	1st layer without load (low range / high range) 5th layer without load (low range / high range)	200 ft/min / 320 ft/min 287 ft/min / 460 ft/min
	Maximum line pull	
	1st layer (low range / high range) 5th layer (low range / high range)	18,450 lb / 10,002 lb 12,845 lb / 6,963 lb
	Permissible line pull	13,800 lb
	6 x 19 IWRC XIPS	
	Rope diameter	3/4 in
	Maximum usable	561 ft

## Hoist, Rope and Hook

### Optional configuration:



**Two speed ratios**

1st layer without load (low range / high range)  
5th layer without load (low range / high range)

200 ft/min / 320 ft/min  
287 ft/min / 460 ft/min



**Maximum line pull**

1st layer (low range / high range)  
5th layer (low range / high range)

18,450 / 10,002 lb  
12,845 / 6,963 lb

**Permissible line pull**

13,800 lb



34 x 7 Grade 960



Rope diameter

3/4 in

## Cab, Controls, Operator aids and Load limiter / Load indicator

### Standard configuration:



**Upper cab:**

Sliding door on left side  
Sliding window on the right side  
Tilting, tinted glass skylight  
Removable front windshield  
Six-way adjustable seat with armrest dual-axis electro-proportional joysticks  
Joystick control for hoist(s), swing and boom elevation  
Foot pedals for swing brake, boom telescope and engine rpm  
Hand control for engine rpm

**Lower cab:**

Hinged door on left side with roll-down window  
Sliding window on the right side  
Six-way adjustable seat with seatbelt  
Cruise control  
Two speed windshield wiper with washer



Rated capacity indicator with pictograph display of boom radius, boom angle, boom length, allowable load, actual load and % of allowable load

Settable alarms for swing angle, boom length, boom angle, tip height and work area exclusion zone



### Optional configuration:



**Upper cab:**

Air conditioning – hydraulically powered  
Heater and air conditioning package – hydraulically powered  
Liquid Propane (LP) Cab Heater  
Single-Axis armrest mounted controls  
Work Lights  
Upper cab remote carrier control  
AM/FM radio with cassette

## Superstructure

Standard configuration:		
	Foot pedal actuated multi-disc brake and air actuated house lock	360°
	Hydraulic driven double planetary reduction gear drive	2.5 rpm

## Counterweight

	Four counterweight packages available	5,000 lb / 7,000 lb / 11,000 lb / 15,000 lb
---	---------------------------------------	---

## Tires

Standard configuration:		
	Aluminium wheels with stainless hub covers	
	Front Tires	445/65 R22.5-20 PR
	Rear Tires	315/80 R22.5-20 PR

## Vehicle performance

Standard configuration:		
	Theoretical maximum	
	Manual transmission	100+ %
	Automatic transmission	100+ %
	Manual transmission	67 mph
	Automatic transmission	65 mph

## Hydraulic system

Standard configuration:		
	<b>Three-pump system:</b>	
	Tandem pump - Main and auxiliary winch; boom hoist and telescope	57.3 / 42.6 gal/min @ 4,500 psi
	Single pump - Outriggers and swing	21.2 gal/min @ 3,500 psi
	Single pump - Power steering	8 gal/min @ 1,900 psi
	Simultaneous operation of hydraulic functions	
	Two-speed boom extension	
	Full Flow with bypass protection:	
	Suction	250 micron screen
	Return	5 micron filter
	Pressurized tank with sight level gauge	202 gal

## Carrier, Engine and Drive-line

### Standard configuration:



Hydraulic assist; Turn radius to centerline of tires

33 ft - 4 in



Axle drive system  
Air brakes with ABS, air release / spring set

8 x 4 drive

Front axle – maximum capacity  
Tubular beam with equalizer air suspension mounting

48,000 lb

Rear axle – maximum capacity  
Interaxle differential with lock-out  
Equalizer beam air suspension mounting

60,000 lb



Engine and transmission, EPA 2010 compliant  
Cummins ISX  
Intake: Turbocharged and intercooled  
Rated power  
Eaton Fuller 10-speed manual transmission  
Fuel type  
Engine brake

14.9 L / 455 hp @ 1,800 rpm

Diesel  
Jacobs type

Fuel tank capacity

100 gallon



Voltage  
3 Batteries  
Alternator

12 VDC  
1,000 CCA each  
130 amp

### Optional configuration:



Engine and transmission, EPA 2010 compliant  
Cummins ISX  
Intake: Turbocharged and intercooled  
Rated power  
Allison 7-speed automatic transmission with lock-up torque converter  
Fuel type  
Engine brake

14.9 L / 500 hp @ 1,600 rpm

Diesel  
Jacobs type



Engine and transmission, Non-EPA 2010 compliant. Export only, not for use in U.S. or Canada  
Detroit Diesel 60 Series  
Intake: Turbocharged and aftercooled  
Rated power  
Eaton Fuller 10-speed manual transmission - Standard  
Allison 7-speed automatic transmission with lock-up torque converter - Optional  
Fuel type  
Engine brake

14 L / 455 hp @ 1,800 rpm

Diesel  
Jacobs type



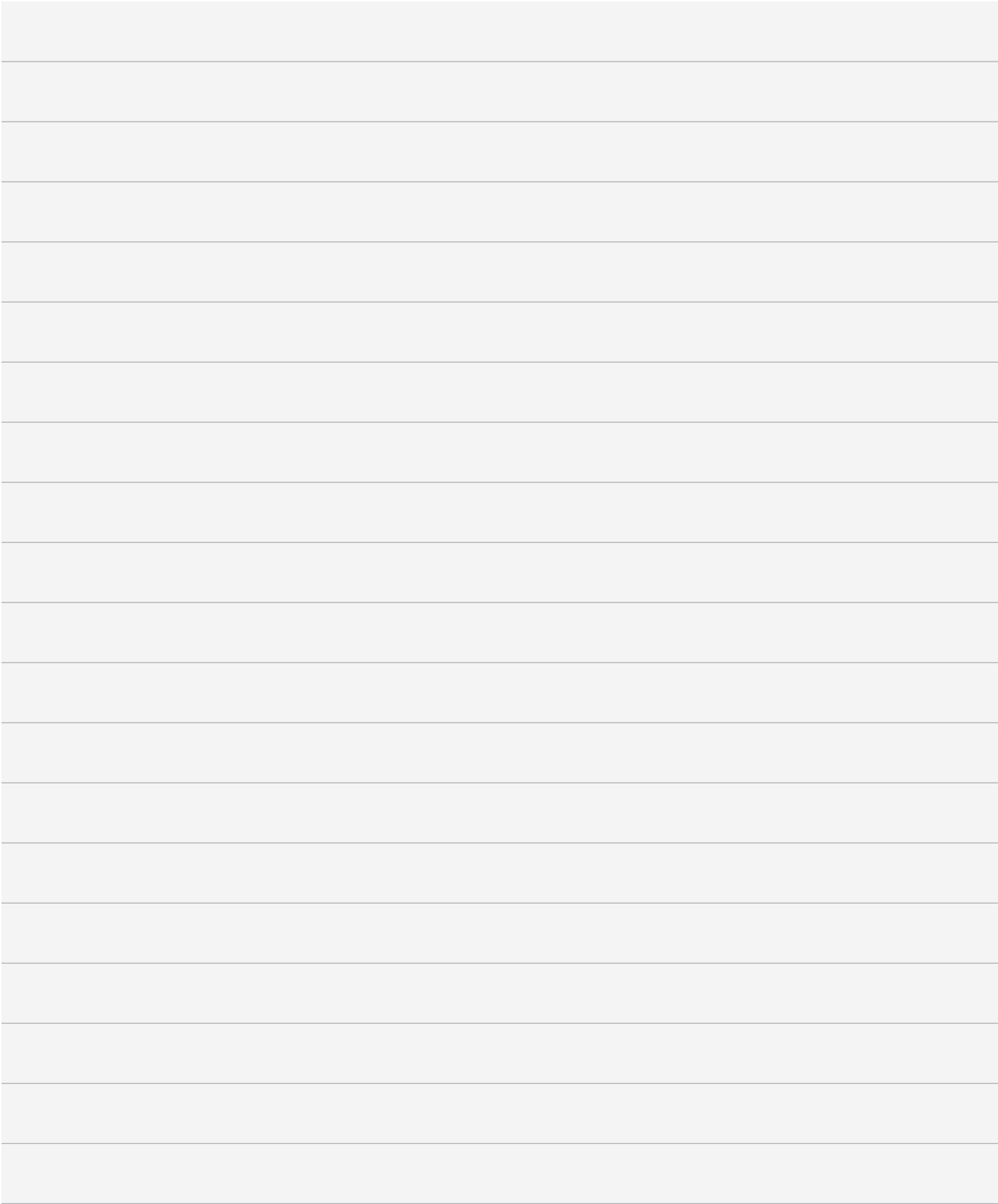

This section of the page is a large, empty rectangular area with a light gray background. It is divided into approximately 22 horizontal rows by thin, dark gray lines, providing a structured space for writing notes.

Effective Date: September 2012. Product specifications and prices are subject to change without notice or obligation. The photographs and/or drawings in this document are for illustrative purposes only. Refer to the appropriate Operator's Manual for instructions on the proper use of this equipment. Failure to follow the appropriate Operator's Manual when using our equipment or to otherwise act irresponsibly may result in serious injury or death. The only warranty applicable to our equipment is the standard written warranty applicable to the particular product and sale and Terex makes no other warranty, express or implied. Products and services listed may be trademarks, service marks or trade-names of Terex Corporation and/or its subsidiaries in the USA and other countries. All rights are reserved. Terex® is a registered trademark of Terex Corporation in the USA and many other countries. Copyright 2012 Terex Corporation.

Terex Cranes, Global Marketing, Dinglerstraße 24, 66482 Zweibrücken, Germany  
Tel. +49 (0) 6332 830, Email: info.cranes@terex.com, www.terexcranes.com



[www.terexcranes.com](http://www.terexcranes.com)

Brochure Reference: TC-DS-I-E-T780-1-09/12



**WORKS FOR YOU.™**